

**EROSION AND  
SEDIMENT CONTROL  
BEST MANAGEMENT PRACTICE  
MANUAL**

WEST VIRGINIA

DEPARTMENT OF ENVIRONMENTAL  
PROTECTION  
DIVISION OF  
WATER AND WASTE MANAGEMENT

2006

REVISED  
AUGUST 29, 2016

## TABLE OF CONTENTS

<b>Chapter 1</b>	<b>INTRODUCTION.....</b>	<b>1-1</b>
	Regulatory Requirements.....	1-2
	State Water Quality Standards .....	1-3
	Total Maximum Daily Loads (TMDLs) .....	1-4
	Local Ordinances .....	1-4
	Endangered Species Act .....	1-4
	Permitting for In-Stream Construction and Wetland Filling ..	1-5
	DNR Stream Activity Application.....	1-5
	Federal Permits .....	1-5
	401 Water Quality Certification.....	1-6
	Acknowledgements.....	1-7
	Corrections.....	1-7
	Future Updates .....	1-7
<b>Chapter 2</b>	<b>How to Prepare a Sediment Control Plan .....</b>	<b>2-1</b>
	Section 1 General Guidelines.....	2-3
	Section 2 Step-By-Step Procedures .....	2-5
	12 Basic Sediment Control Plan Elements .....	2-7
	Section 3 Checklist for Sediment Control Plans.....	2-13
<b>Chapter 3</b>	<b>Standards and Specifications.....</b>	<b>3-1</b>
	<b>Erosion Control</b>	
	Preserving Existing Vegetation.....	3.01-1
	Stabilized Construction Entrance.....	3.02-1
	Temporary Construction Road, Work and Parking	
	Area Stabilization.....	3.03-1
	Safety Fence.....	3.04-1
	Rock Check Dams.....	3.05-1
	Wattles .....	3.06-1
	Commercial Silt Dikes.....	3.07-1
	Surface Roughening.....	3.08-1
	Topsoiling .....	3.09-1
	Temporary Seeding.....	3.10-1
	Permanent Seeding.....	3.11-1
	Mulching including Flexible Growth Medium and	
	Bonded Fiber Matrix.....	3.12-1
	Rolled Erosion Control Products .....	3.13-1
	Sodding .....	3.14-1
	Temporary Diversions .....	3.15-1
	Pipe Slope Drain .....	3.16-1
	Outlet Protection .....	3.17-1
	Right of Way Diversion.....	3.18-1
	Level Lip Spreader.....	3.19-1

	Surface Water Control .....	3.20-1
	Instream BMPs.....	3.21-1
	Dewatering.....	3.22-1
	Riprap.....	3.23-1
	Geotextiles .....	3.24-1
	<b>Sediment Control</b>	
	Vegetative Buffer Strip.....	3.25-1
	Reserved.....	3.26-1
	Silt Fence .....	3.27-1
	Super Silt Fence .....	3.28-1
	Sediment Trap.....	3.29-1
	Sediment Basin .....	3.30-1
	Reserved.....	3.31-1
	Reserved.....	3.32-1
	Inlet Protection.....	3.33-1
	Reserved.....	3.34-1
	Access/Low Volume Road/Driveways .....	3.35-1
<b>Chapter 4</b>	<b>Urban Hydrology for Small Watersheds (TR-55) .....</b>	<b>4-1</b>
<b>Chapter 5</b>	<b>Design Examples .....</b>	<b>5-1</b>
	Sediment Basin Design Example.....	5-1
	Stormwater Management Pond Design Example .....	5-6
<b>Chapter 6</b>	<b>Sample plans.....</b>	<b>6-1</b>
	Individual house.....	6
	Typical Site grading.....	6
	Utility line .....	6
<b>Chapter 7</b>	<b>Stream Restoration Standard</b>	
	<b>Guidelines and Specifications .....</b>	<b>7-1</b>
	Stream Restoration Introduction.....	7 7-2
	In-Stream Structures, Riffles and Pools.....	7.01-1
	Constructed Benches and Floodplains .....	7.02-1
	New Channel Construction.....	7.03-1
	Transporting Material on the Stream Bed.....	7.04-1
<b>Chapter 8</b>	<b>Steep Slope Construction Guidelines in Areas</b>	
	<b>Of High Slip Potential Soils .....</b>	<b>8-1</b>
	Steep Slope Construction Guidelines.....	8-2
	Drain Requirements .....	8-3
	Bleeder Drain and Outlet Detail .....	8-4
	Bleeder Drain Parallel to Pipeline.....	8-5
	Trench Plug Drain Overview.....	8-6
	Trench Plug Drain Details. ....	8-7
	Side Hill Construction.....	8-8
	Side Hill Construction Drain.....	8-9

Drain Outlet Requirements.....8-10  
Subsurface Drain (French Drain).....8-11  
Seep Intercept Drain (Parallel to Trench).....8-12

**Appendix A Glossary .....A-1**  
**Appendix B Miscellaneous (MS4s and Endangered Species).....B-1**  
**Appendix C References.....C-1**  
**Appendix D High Slip Potential Soils by County.....D-1**

## LIST OF TABLES

Table 3.04.1	Physical Properties of Plastic Safety Fence .....	3.04-1
Table 3.10.1	Temporary Seed Chart .....	3.10-3
Table 3.11.1	Permanent Seeding.....	3.11-4
Table 3.11.2	Nurse Crops .....	3.11-6
Table 3.11.3	Permanent Seeding Requirements .....	3.11-7
Table 3.12.1	Organic Mulch Materials and Application Rates.....	3.12-5
Table 3.13.1	ECTC Standard Specification for Temporary Rolled Erosion Control Products.....	3.13-5
Table 3.13.2	ECTC Standard Specification for Permanent Rolled Erosion Control Products.....	3.13-6
Table 3.13.3	Permissible Velocities for Earth Linings .....	3.13-7
Table 3.13.4	Permissible Velocities for Grass-lined Channels.....	3.13-8
Table 3.15.1	Channel Cross Section Requirements .....	3.15-4
Table 3.15.2	Channel Stabilization Requirements.....	3.15-4
Table 3.15.3	Permissible Velocities for Grass-lined Channels.....	3.15-5
Table 3.15.4	Maximum Permissible Design Velocities.....	3.15-6
Table 3.16.1	Pipe Sizes for Pipe Slope Drain.....	3.16-1
Table 3.17.1	Permissible Velocities for Grass-Lined Channels .....	3.17-5
Table 3.17.2	Permissible Velocities for Earth Linings .....	3.17-6
Table 3.18.1	Right-of-way Diversion Spacing .....	3.18-1
Table 3.21.1	Average Slope of Watershed .....	3.21-7
Table 3.21.2	Stream Diversion Linings .....	3.21-9
Table 3.22.1	Geotextile Fabric Properties .....	3.22-3
Table 3.23.1	AASHTO Riprap Gradation Classes .....	3.23-2
Table 3.24.1	List of Geotextile Tables.....	3.24-4
Table 3.24.2	Geotextile for Underground Drainage Strength Properties for Survivability.....	3.24-5
Table 3.24.3	Geotextile for Underground Drainage Filtration Properties .....	3.24-5
Table 3.24.4	Geotextile for Separation or Soil Stabilization .....	3.24-6
Table 3.24.5	Geotextile for Permanent Erosion and Ditch Lining .....	3.24-7
Table 3.24.6	Filtration Properties for Geotextile for Permanent Erosion Control.....	3.24-8
Table 3.24.7	Geotextile for Temporary Silt Fence .....	3.24-8
Table 3.29.1	Pipe Outlet Diameter Selection.....	3.29-3
Table 3.29.2	Sediment Trap Key Design Aspects .....	3.29-4
Table 3.35.1	Average Slope of Watershed .....	3.35-6

## LIST OF FIGURES

Figure 3.01.1	Preserving Natural Vegetation.....	3.01-5
Figure 3.01.2	Tree Protection Zone.....	3.01-6
Figure 3.01.3	Tree Well When Filling Over Tree Roots.....	3.01-7
Figure 3.02.1	Stone Construction Entrance.....	3.02-2
Figure 3.05.1	Rock Check Dam.....	3.05-3
Figure 3.05.2	Rock Check Dam Spacing.....	3.05-4
Figure 3.06.1	Wattles.....	3.06-3
Figure 3.06.2	Straw Wattle Ditch Check.....	3.06-4
Figure 3.08.1	Surface Roughening – Cut Slope Treatment.....	3.08-3
Figure 3.08.2	Surface Roughening – Fill Slope Treatment.....	3.08-4
Figure 3.13.1	Typical RECP Channel Installation.....	3.13-9
Figure 3.13.2	Rolled Erosion Control Products.....	3.13-10
Figure 3.15.1	Typical Diversions.....	3.15-8
Figure 3.15.2	Temporary Fill Diversions.....	3.15-9
Figure 3.15.3	Riprap Diversion.....	3.15-10
Figure 3.16.1	Pipe Slope Drain.....	3.16-3
Figure 3.17.1	Design of Outlet Protection from a Round Pipe Flowing Full, Maximum Tailwater Condition.....	3.17-8
Figure 3.17.2	Design of Outlet Protection from a Round Pipe Flowing Full, Minimum Tailwater Condition.....	3.17-9
Figure 3.17.3	Outlet Protection –Discharge to Unconfined Section.....	3.17-10
Figure 3.17.4	Outlet Protection Discharge to Confined Section.....	3.17-11
Figure 3.17.5	Outlet Protection – Discharge to Semi-Confined Channel....	3.17-12
Figure 3.18.1	Right-of-way Diversions – Plan.....	3.18-3
Figure 3.18.2	Right-of-way Diversions – Cross Section.....	3.18-4
Figure 3.19.1	Level Spreader.....	3.19-3
Figure 3.20.1	Surface Water Control – Plan.....	3.20-4
Figure 3.20.2	Surface Water Control – Excavation & Fill.....	3.20-5
Figure 3.20.3	Side Hill Cut and Fill.....	3.20-6
Figure 3.20.4	Fill with Rock Under Drain – Section A-A.....	3.20-7
Figure 3.20.5	Fill with Rock Under Drain – Plan.....	3.20-8
Figure 3.20.6	Fill with Rock Channels.....	3.20-9
Figure 3.21.1	Pump Around.....	3.21-12
Figure 3.21.2	Flume Pipe Crossing.....	3.21-13
Figure 3.21.3	Cofferdams.....	3.21-14
Figure 3.21.4	Cofferdams Crossing.....	3.21-15
Figure 3.21.5	Stream Bank Stabilization Showing of E&S Controls.....	3.21-16
Figure 3.21.6	Diversion Channel Crossing.....	3.21-17
Figure 3.21.7	Toe and Underlayment Requirements.....	3.21-18
Figure 3.21.8	Temporary Bridge Crossing.....	3.21-23
Figure 3.21.9	Culvert Stream Crossing.....	3.21-24
Figure 3.22.1	Sump Pit.....	3.22-5
Figure 3.22.2	Straw Bale/Silt Fence Pit.....	3.22-6

Figure 3.22.3	Dewatering Bag .....	3.22-7
Figure 3.22.4	Dewatering Discharge in Upland Area .....	3.22-8
Figure 3.23.1	Angle of Repose.....	3.23-5
Figure 3.23.2	Toe Requirement for Bank Stabilization .....	3.23-8
Figure 3.27.1	Placement of Silt Fence .....	3.27-5
Figure 3.27.2	Silt Fence .....	3.27-4
Figure 3.28.1	Super Silt Fence .....	3.28-3
Figure 3.29.1	Rock Outlet Sediment Trap .....	3.29-6
Figure 3.29.2	Pipe Riser Sediment Trap .....	3.29-7
Figure 3.29.3	Culvert Inlet Sediment Trap.....	3.29-8
Figure 3.30.1	How a Sediment Basin Works .....	3.30-13
Figure 3.30.2	Sediment Basin .....	3.30-14
Figure 3.30.3	Basin Schematic.....	3.30-15
Figure 3.30.4	Principal Spillway Design.....	3.30-16
Figure 3.30.5	Excavated Earth Spillway .....	3.30-17
Figure 3.30.6	Trash Rack .....	3.30-18
Figure 3.30.7	Sediment Basin or Trap Dewatering Device .....	3.30-19
Figure 3.33.1	Silt Fence Drop Inlet Protection .....	3.33-7
Figure 3.33.2	Gravel and Wire Drop Inlet Protection.....	3.33-8
Figure 3.33.3	Block and Gravel Drop Inlet Sediment Filter.....	3.33-9
Figure 3.33.4	Pipe Riser and Gravel Drop Inlet Protection .....	3.33-10
Figure 3.33.5	Excavated Drop Inlet Protection.....	3.33-11
Figure 3.33.6	Gravel and Wire Curb Inlet Protection .....	3.33-12
Figure 3.33.7	Curb Inlet Protection with 2" x 4" Wooden Weir.....	3.33-13
Figure 3.33.8	Block and Gravel Curb Inlet Protection.....	3.33-14
Figure 3.33.9	Gravel Bag Curb Inlet Protection .....	3.33-15
Figure 3.35.1	Types of Road Cross-Sections.....	3.35-9
Figure 3.35.2	Sediment and Erosion Control for Access Roads .....	3.35-10
Figure 3.35.3	Broad-Based Dip.....	3.35-11
Figure 3.35.4	Water Bar .....	3.35-12
Figure 3.35.5	Culvert Stream Crossing.....	3.35-13
Figure 6.1	Individual House Lot Sediment Control Plan.....	6-2
Figure 6.2	Silt Fence .....	6-9
Figure 6.3	Stone Construction Entrance.....	6-10
Figure 6.4	Downspout Control.....	6-11
Figure 7.01.1	In-Stream Diversion (Dry).....	7.01-3
Figure 7.01.2	In-Stream Diversion (Wet) .....	7.01-4
Figure 8.6	Spacing of Trench Plugs in High Slip Potential Soils.....	8.6

# CHAPTER 1

## INTRODUCTION



# CHAPTER 1

## INTRODUCTION

Erosion is a natural force without which life could not be supported. Erosion forms the landscape and helps produce the soils that grow our crops. However, major problems can occur when large amounts of sediment enter our waterways. Accelerated erosion comes from man's land-altering activities such as mining, agriculture, construction, urban/suburban stream banks, logging, and oil and gas exploration.

The West Virginia Department of Environmental Protection (WVDEP) Erosion and Sediment Control Best Management Practice Manual addresses erosion and sediment control for earth disturbing activities associated with construction. The manual is designed to assist construction site developers, engineers, designers, and contractors to identify and implement the most appropriate best management practices (BMPs) for construction activities.

The purpose of this manual is to provide standardized and comprehensive erosion and sediment control management practices that can be implemented on construction projects throughout West Virginia. This manual should be used as guidance for developing sediment control plans for the General West Virginia/National Pollution Discharge Elimination System Water Pollution Control Permit for Stormwater Associated with Construction Activities. However, the use of other best management practices manuals may also be acceptable. The goal is to reduce the water quality impacts of land-disturbing activities through design and implementation of effective erosion prevention and sediment control.

West Virginia's original manual was created in 1982. While the principles of erosion prevention and sediment control have changed little, a new manual was needed to cover the advancements of the last 24 years. This manual provides updated information on erosion prevention and sediment control measures, engineering methods, and changes in the law and regulations. It should be used by the regulated community, citizens and municipalities developing their own erosion and sediment control rules and regulations.

## **REGULATORY REQUIREMENTS**

Erosion and sediment control requirements exist at the federal, state and local levels of government. Some city and county governments have adopted site development or sediment control ordinances or regulations, usually through subdivision regulations. Developers and contractors should check with local governments to determine whether ordinances may affect their proposed activities. Over the next several years, many municipalities will be developing their own sediment control requirements to meet the provisions of the Municipal Separate Storm Sewer System (MS4) General Permit.

### **Federal and State Sediment Control Requirements**

Congress amended the Clean Water Act (CWA) in 1987, requiring a two-phase program be implemented to regulate stormwater discharges. The U.S. Environmental Protection Agency (EPA) promulgated the Phase I regulations in 1990, which, among other things, required National Pollutant Discharge Elimination System (NPDES) permit coverage for most stormwater discharges from construction activities. EPA authorized WVDEP to administer the NPDES program in West Virginia. WV DEP issued the first NPDES General Permit for stormwater discharges from construction activities in 1992 and has issued follow up General Permits every five years since that time. In 1999, EPA issued the Phase II regulations requiring NPDES permit coverage for sites with one acre or more of land disturbance. West Virginia's current General WV/NPDES Water Pollution Control Permit for stormwater associated with construction activities covers projects with one acre or more of earth disturbance.

### **Construction Projects that Need a Permit for Stormwater Discharge**

Any land-disturbing activity that will disturb an area of one acre or more is required to be covered under an NPDES permit for its stormwater discharge. In addition, sites that disturb less than one acre that are part of a "common plan of development or sale" may also need to be covered by this permit. A common plan of development is a contiguous construction project where multiple separate and distinct construction activities may be taking place at different times and on different schedules, but under one plan. The "plan" is broadly defined as any announcement, piece of documentation or physical demarcation indicating construction activities may occur on a specific plot; most subdivisions are included in this definition.

Construction of single family residences by the homeowner or homeowner's contractor requiring land disturbances less than three acres in size are provided coverage under the General WV/NPDES Water Pollution Control Permit and do not require application for registration. All other terms and conditions of the General Permit, except for the Notice of Termination requirement, still apply.

## **State Water Quality Standards**

West Virginia has several water quality standards that can address runoff from earth disturbing activities. The first are numerical water quality criteria. These are numerical values set forth in the state of West Virginia's Water Quality Standards [47 CSR 2]. They specify the levels of pollutants allowed in receiving waters that are protective of the stream's designated use. Designated uses can be to protect public water supply, for protection of fish, shellfish, and wildlife, and for recreational, agricultural, industrial, and navigational purposes.

Waste assimilation and transport are not designated uses. Therefore sediment traps and basins cannot be installed in waters of the State. Also, streams cannot be used to transport sediment from a construction site to a sediment trap or basin.

The primary numeric water quality standard addressing earth disturbing activities is turbidity. Other criteria that could be violated by runoff from a construction project include pH and iron.

Turbidity is defined as an expression of the optical property that causes light to be scattered and absorbed rather than transmitted in straight lines through the sample. It is an indirect measurement of how much suspended material is in a sample of water.

In West Virginia, turbidity in the receiving stream shall not exceed 10 nephelometric turbidity units (NTU) over background turbidity when the background turbidity is 50 NTU or less, or have more than a 10 percent increase plus 10 NTU in turbidity when the background turbidity is more than 50 NTU. The points of measurement are directly above and below the point of discharge [47 CSR 2-8.32].

There are also narrative water quality criteria, listed as "Conditions Not Allowable in State Waters" [47 CSR 2-3]. Several of these are applicable to earth disturbing activities including the prohibition against the following conditions: distinctly visible floating or settleable solids, suspended solids, scum, foam or oily slicks, deposits or sludge banks. Also the discharge must not contain materials that have taste or color or have materials in concentrations that are harmful, hazardous or toxic to man, animal or aquatic life.

## **Compliance with Standards**

Surface water discharges associated with construction activity are subject to applicable state water quality standards. The Construction Stormwater General Permit does not authorize the violation of those standards. WVDEP expects that the selection and implementation of appropriate BMPs will result in compliance with standards for surface water discharges from construction sites. Proper implementation and maintenance of these controls is critical to adequately control any adverse water quality impacts from construction activity.

## **Total Maximum Daily Loads (TMDLs)**

If construction activities will contribute pollutants for which a specific receiving water is listed as impaired, permittees must comply with Total Maximum Daily Loads (TMDLs) set for the receiving stream. Construction sites may be designated as contributors to the impairment if a stream is listed as impaired because of sediment or iron. Section 303(d) of the CWA established the TMDL process to guide the application of state water quality standards to individual water bodies and watersheds. A TMDL defines the amount of a particular pollutant that a water body can absorb daily without violating applicable water quality standards. Once this load is established, the WVDEP allocates a portion to each source of that pollutant within a particular watershed. In the case of construction activities within an impaired watershed, the WVDEP may require the permittee to implement more stringent BMPs, apply for an individual NPDES permit, or take other necessary actions to ensure compliance with TMDL discharge requirements. To find out if there are additional TMDL-related requirements for your project, please contact the WVDEP Stormwater Program.

## **Local Ordinances**

Local regulations, such as zoning and subdivision ordinances, may also regulate construction activities in West Virginia. Numerous cities have subdivision requirements. Some counties and most larger cities have some sort of zoning regulations. Check the phone book under county and city for "Planning Commission". If there is no Planning Commission, contact the city government and county commissions.

Each county and city in the state is required to have a floodplain ordinance in order for residents to qualify for flood insurance. The local governmental authority in charge of the program regulates projects that physically alter land within the 100-year flood zone. When there is a Planning Commission in a county, it is usually their responsibility to manage and enforce the regulations. In other counties the applicant should contact the County Commission.

## **Endangered Species Act**

If a construction project discharges to a receiving water where a federally endangered or threatened species or its habitat is present, potential impacts to that species need to be considered. For information on Endangered Species Act implementation in West Virginia and developing project-specific compliance strategies contact the U. S Fish and Wildlife Service in Elkins at:

U.S. Fish and Wildlife Service  
West Virginia Field Office  
P.O. Box 1278  
Elkins, WV 26241  
304-636-6586

Appendix B lists water bodies where Endangered Species may be found.

## **Permits for In-Stream Construction and Wetland Filling**

Developers proposing to conduct construction activities in waterways, including jurisdictional wetlands, may be required to obtain permits from the US Army Corps of Engineers (USACE) and/or the West Virginia Division of Natural Resources (DNR) Office of Land and Streams, as well as WVDEP depending on the project scope and location.

### **DNR Stream Activity Application**

The Office of Land and Streams holds the title to the “waters of the state”. Waters of the state “... means any and all water on or beneath the surface of the ground, whether percolating, standing, diffused or flowing, wholly or partially within this state, or bordering this state and within its jurisdiction, and includes without limiting the generality of the foregoing, natural or artificial lakes, rivers, streams, creeks, branches, brooks, ponds (except farm ponds, industrial settling basins and ponds and water treatment facilities), impounding reservoirs, springs, wells, watercourses and wetlands” [22 CSR 12-3].

A DNR Stream Activity Application is required for construction activities that occur within the normal high water mark of a stream in West Virginia. Information on this program and application forms made be obtained at:

Office of Land and Streams  
Building 3, Room 643  
1900 Kanawha E  
Charleston, WV 25305  
304-558-3225  
<http://www.wvdnr.gov/REM/PLC.shtm>

### **Federal Permits**

The USACE administers Section 404 of the Clean Water Act (CWA) and Section 10 of the Rivers and Harbors Act of 1899. Under these jurisdictions, the USACE have issued a number of general Nationwide Permits for certain activities or similar types of activities that have a minimal impact on navigable waters (Section 10 permits) or waters of the U.S. (Section 404 permits). For activities not covered under a Nationwide Permit, the developer will need to apply for an Individual Permit.

Section 404 of the CWA establishes a program to regulate the discharge of dredged or fill material into waters of the U.S, including jurisdictional wetlands. Construction activities covered under this program include fill for commercial site development, subdivisions and infrastructure development (such as highways, airports and utility lines).

The USACE conducts and verifies wetland determinations and has the final say on jurisdiction. The USACE also develops policy and guidance on stream and wetland issues and enforces Section 404 permits and provisions.

The ACE District offices are located in Pittsburgh and Huntington.

**HUNTINGTON DISTRICT**

Regulatory Branch Chief  
U.S. Army Corps of Engineers,  
Huntington District  
502 Eighth Street  
Huntington, West Virginia 25701-2070  
Phone: 304-399-5710

**PITTSBURGH DISTRICT**

Regulatory Branch Chief  
U.S. Army Corps of Engineers,  
Pittsburgh District  
William S. Moorhead Federal Building  
1000 Liberty Avenue  
Pittsburgh, Pennsylvania 15222-4186  
Phone: 412-395-7152

**401 Water Quality Certification**

Section 401 Water Quality Certification is required for each permit or license issued by a federal agency to ensure that proposed projects will not violate the state's water quality standards or stream designated uses. States are authorized to issue Certification under Section 401 of the CWA.

The majority of certification requests are for dredge and fill operations regulated by the US Army Corps of Engineers. The US Coast Guard issues permits for bridge construction on navigable waterways. The Federal Energy Regulatory Commission is responsible for licenses related to hydropower facilities. Applicants must receive State 401 Water Quality Certification before they can receive a permit from the federal agency.

The DWWM may grant, grant with conditions, waive, or deny 401 Water Quality Certification. The decision to issue certification is based on project compliance with West Virginia Water Quality Standards. Field support for the 401 program is provided by the DNR's Wildlife Resources Section.

Information on this program and application forms made be obtained at:

401 Certification Program  
Division of Water and Waste Management  
601 57th Street, SE  
Charleston, WV 25304  
(304) 926-0495

## **ACKNOWLEDGEMENTS**

Development of this manual was begun in the mid-1990s and the current document has survived numerous staffing changes, agency and program reorganizations, and multiple edits and revisions. As such, it has become almost impossible to identify all who may have contributed to the manual and the exact sources of some of the information. We have attempted in the final edit to eliminate any information that could not be properly documented. The State Conservation Agency coordinated a multi-agency committee that established much of the early work on this manual. Several WVDEP staff contributed to the manual. The draft document was completed under a contract with Parsons Brinckerhoff Quade & Douglas, funded by a federal Clean Water Act grant from the US Environmental Protection Agency to the WV DEP DWWM. Final editing was completed by WVDEP Stormwater Program staff.

### **Technical sources:**

Technical sources are noted in the document.

### **Corrections**

Any errors or omissions are the responsibility of the WVDEP. Please report any errors or omissions to the WVDEP DWWM for correction.

### **Future updates**

Modifications to the handbook will be necessary from time to time. The handbook has been designed to be a living document and will be updated as new information or revisions are obtained.

# CHAPTER 2

HOW TO PREPARE A SEDIMENT CONTROL PLAN



# How to Prepare a Sediment Control Plan

---

This chapter provides an overview of the important components of, and the process for, developing and implementing the sediment control plan (SCP) component of the construction stormwater pollution prevention plan (SWPPP).

**Section 1** contains general guidelines with which site planners should become familiar. It describes criteria for plan format and content and ideas for improved plan effectiveness.

**Section 2** outlines and describes a recommended step-by-step procedure for developing a SCP from data collection to finished product. This procedure is written in general terms to be applicable to all types of projects.

**Section 3** includes a checklist for developing a SCP.

Design standards and specifications for best management practices (BMPs) referred to in this chapter are found in Chapter 3.

The SCP and SWPPP are separate stand-alone documents but should be integrated into the overall construction plan set.

# Section 1

## ***General Guidelines***

---

### **What is a construction stormwater pollution prevention plan and how is it different from a sediment control plan?**

The **construction stormwater pollution prevention plan** (SWPPP) is the overall document that describes the potential for pollution problems on a construction project and explains and illustrates the measures to be taken to control those problems.

A **sediment control plan** (SCP) is the document that deals exclusively with controlling erosion and sediment during the construction phase.

The SWPPP consists of several components including: the SCP, one or two groundwater protection plans, a stormwater management plan (if necessary) and a plan to control other pollutants. This manual provides practices and procedures necessary to develop a SCP.

The DEP reviews the Construction SWPPPs for compliance and adequacy in controlling erosion and sediment and other pollutants during construction. Single-family home construction projects may use the generic individual house sediment control plan.

The construction SWPPP is a separate and complete document. However, the appropriate sections (SCP in particular) should be incorporated into the contract drawings and documents. The construction SWPPP and site registration application must be located on the construction site for examination by DEP inspection personnel. As site work progresses, the plan must be modified to reflect changing site conditions that affect sediment and erosion control practices. These changes are subject to the permit modification procedures for the state.

### **What is in a sediment control plan?**

The SCP for projects that disturb more than one acre must contain sufficient information to satisfy the state that the pollution problems have been adequately addressed for the proposed project. An adequate SCP includes both a narrative and drawings. The narrative is a written statement to explain the pollution prevention decisions made for a particular project. The narrative contains information about existing site conditions, proposed site conditions, construction schedules and sequence of events, design and calculations and other pertinent items. The drawings and notes describe where and when the various BMPs should be installed and the construction drawings and details of each practice mentioned in the narrative.

On construction sites the primary concern in the preparation of the SCP is impacts to surface water and groundwater. Each of the 12 elements found in the following section should be included in the SCP unless an element is determined not to be applicable to the project.

### **Best management practice guidelines and specifications**

Chapter 3 contains guidelines and specifications for the BMPs referred to in this chapter.

The guidelines and specifications in Chapter 3 of this volume are not intended to limit any innovative or creative effort to effectively control erosion and sedimentation. In those instances where appropriate BMPs are not in this chapter, experimental practices can be considered. Some modifications to guideline practices may also be employed. However, the DEP must approve

such practices before they may be used. All experimental practices and modified guideline practices are required to achieve the same or better performance of the BMPs listed in Chapter 3.

### **General principles**

The following general principles should be applied to the development of the SCP:

- The duff layer, native topsoil, and natural vegetation should be retained in an undisturbed state to the maximum extent practicable.
- Prevent pollutant release. Select source control BMPs as a first line of defense. Erosion prevention can be easier than treating turbid runoff.
- Select BMPs depending on site characteristics (topography, drainage, soil type, ground cover, and critical areas) and the construction plan.
- Divert runoff away from exposed areas wherever possible. Keep clean water clean.
- Limit the extent of clearing operations and phase construction operations.
- If topsoil is not available, amend all soils with appropriate lime and fertilizer prior to seeding.
- Maintain and protect natural drainage features whenever possible.
- Minimize slope length and steepness.
- Control water through the use of diversions and slope drains.
- Reduce runoff velocities to prevent channel erosion.
- Prevent the tracking of sediment offsite.
- Control pollutants other than sediment.
- Anticipate rain. View the project controls as if there will be a significant rain event at some point during construction. Determine where runoff will drain to at each stage of the project and make sure there will be an appropriate sediment control device there to intercept it.
- Remember that the ground won't dry out as fast during the winter as it does in the summer.
- Be realistic about the limitations of controls that you specify and the operation and maintenance of those controls. Anticipate what can go wrong, how you can prevent it from happening, and what will need to be done to fix it.

## *Section 2*

### *Step-By-Step Procedures*

---

There are three basic steps in producing a sediment control plan:

Step 1 - Data collection

Step 2 - Data analysis

Step 3 - SCP development and implementation

Steps 1 and 2 described below are intended for projects that disturb one acre or more. Single-family home construction projects that are part of common plan of development or sale may use the simpler generic individual house sediment control plan.

#### **Step 1 - Data collection**

Evaluate existing site conditions and gather information that will help develop the most effective SCP. The information gathered should be explained in the narrative and shown on the drawings.

- Topography - Prepare a topographic drawing of the site to show the existing contour elevations at intervals of at most five feet depending upon the slope of the terrain.
- Drainage - Locate and clearly mark existing drainage swales and patterns on the drawing, including existing storm drainpipe systems.
- Soils - Identify and label soil type(s) and erodibility (low, medium, high, or an index value from the NRCS manual) on the drawing. Soils information can be obtained from a soil survey if one has been published for the county. If a soil survey is not available, a request can be made to a local Natural Resource Conservation Service office.

Soils must be characterized for permeability, percent organic matter, and effective depth by a qualified soil professional or engineer. These qualities should be expressed in averaged or nominal terms for the subject site or project.

- Ground cover - Label existing vegetation on the drawing. Such features as tree clusters, grassy areas, and unique or sensitive vegetation should be shown. Unique vegetation may include existing trees above a given diameter. Local requirements regarding tree preservation should be investigated. In addition, existing denuded or exposed soil areas should be indicated.
- Critical areas - Delineate critical areas adjacent to or within the site on the drawing. Such features as steep slopes, streams, floodplains, lakes, and wetlands should be shown. Delineate setbacks and buffer limits for these features on the drawings. Other related jurisdictional boundaries such as the Federal Emergency Management Agency (FEMA) base floodplain should also be shown on the drawings.
- Adjacent areas - Identify existing buildings, roads, and facilities adjacent to or within the project site on the drawings. Identify existing and proposed utility locations, construction clearing limits, and erosion and sediment control BMPs on the drawings.
- Existing encumbrances - Identify wells, existing and abandoned septic drain fields, utilities, easements, and site constraints.
- Precipitation records - Determine the average monthly rainfall and rainfall intensity for the required design storm events.

## **Step 2 - Data analysis**

Consider the data collected in Step 1 to visualize potential problems and limitations of the site. Determine those areas that have critical erosion hazards. The following are some important factors to consider in data analysis:

- Topography - The primary topographic considerations are slope steepness and slope length. The longer and steeper the slope, the greater the erosion potential.
- Drainage - Natural drainage patterns should be maintained as much as possible in the developed site. Care should also be taken to ensure that increased runoff from the site will not erode or flood the existing natural drainage system. Possible sites for temporary surface water retention and detention should be considered at this point.

Direct construction away from areas of saturated soil - areas where ground water may be encountered - and critical areas where drainage will concentrate. Preserve natural drainage patterns on the site.

- Soils - Evaluate soil properties such as surface and subsurface runoff characteristics, depth to impermeable layer, depth to seasonal ground water table, permeability, shrink-swell potential, texture, settleability, and erodibility. Develop the SCP based on known soil characteristics.
- Ground cover – Preserving ground cover is the most important factor in terms of preventing erosion. Existing vegetation that can be saved will prevent erosion better than constructed BMPs. Trees and other vegetation protect the soil structure. If the existing vegetation cannot be saved, consider such practices as phasing construction, temporary seeding, and mulching. Phasing of construction involves stabilizing one part of the site before disturbing another. In this way, the entire site is not disturbed at once.
- Critical areas - Critical areas may include flood hazard areas, mine hazard areas, slide prone areas, sole source aquifers, wetlands, stream banks, streams, and other water bodies. Any critical areas within or adjacent to the development should exert a strong influence on land development decisions. Critical areas and their buffers shall be delineated on the drawings and clearly flagged in the field. Orange plastic fencing may be more useful than flagging to assure that equipment operators stay out of critical areas. Only unavoidable work should take place within critical areas and their buffers. Such unavoidable work may require special BMPs, permit restrictions, and mitigation plans.
- Adjacent areas - An analysis of adjacent properties should focus on areas upslope and down slope from the construction project. Waterbodies that will receive direct runoff from the site are a major concern. The types, values, and sensitivities of and risks to downstream resources, such as private property, surface water facilities, public infrastructure, or aquatic systems, should be evaluated. Care must be taken where upslope diversions will exit the property.

Erosion and sediment controls should be selected accordingly.

- Timing of the project - An important consideration in selecting BMPs is the timing and duration of the project. Projects that will proceed during the winter or that will last through several seasons must take precautions to remain in compliance with the SWPPP and General Permit. Requirements for some practices, especially seeding and mulching, can change according to the season they are implemented.

## **Step 3 - SCP development and implementation**

After collecting and analyzing the data to determine the site limitations, the planner can then develop a SCP. Each of the 12 elements below must be considered and included in the SCP unless site conditions render the element unnecessary.

## ***12 Basic Sediment Control Plan Elements***

---

### **Element #1: Mark clearing limits**

- Prior to beginning land disturbing activities, clearly mark all clearing limits, sensitive areas and their buffers, and trees that are to be preserved within the construction area. These shall be clearly marked, both in the field and on the plans, to prevent damage and offsite impacts.
- Plastic, metal, or stake wire fence may be used to mark the clearing limits.
- Suggested BMPs:
  - Preserving natural vegetation
  - Buffer zones
  - Safety fence

### **Element #2: Establish construction access**

- Construction vehicle access and exit should be limited to one route if possible.
- Access points shall be stabilized with crushed aggregate to minimize the tracking of sediment onto public and private roads.
- Wheel wash or tire baths should be located on site, if applicable.
- No sediment tracking on the roadway is allowed. In the event that sediment is inadvertently tracked onto the road, the road shall be cleaned thoroughly by the end of each day. Sediment shall be removed from roads by shoveling or pickup sweeping and shall be transported to a controlled sediment disposal area. Street washing of sediments to the storm drain system is not allowed. If street wash wastewater can be controlled from entering the storm drainage system, then it shall be pumped back onto the site, contained, and disposed of properly.
- Construction access restoration shall be equal to or better than the pre-construction condition.
- Suggested BMPs:
  - Stabilized construction entrance
  - Construction road/parking area stabilization

### **Element #3: Install sediment controls**

- The duff layer, native topsoil, and natural vegetation shall be retained in an undisturbed state to the maximum extent practicable.
- Prior to leaving a construction site, surface water runoff from disturbed areas shall pass through a sediment basin/trap or other appropriate and approved sediment removal BMP.
- BMPs intended to trap sediment on site shall be constructed as one of the first steps in grading. These BMPs shall be functional before other land disturbing activities take place.
- Earthen structures such as dams, dikes, and diversions shall be seeded and mulched according to the timing indicated in Element #5.
- Suggested BMPs:
  - Sediment trap
  - Temporary sediment basin
  - Silt fence
  - Super silt fence

- Drop inlet protection
- Vegetated strip
- Wattles

**Element #4: Stabilize soils**

- Exposed and unworked soils shall be stabilized by application of effective BMPs that protect the soil from the erosive forces of raindrops, flowing water, and wind. The General Permit requires that all graded areas that are at final grade must be seeded and mulched within 7 days and areas that will not be worked again for 21 days or more must be seeded and mulched within 7 days.
- Applicable practices include, but are not limited to, temporary and permanent seeding, sodding, mulching, erosion control fabrics and matting, soil application of polyacrylamide (PAM), the early application of gravel base on areas to be paved, and dust control.
- Selected soil stabilization measures shall be appropriate for the time of year, site conditions, and estimated duration of use.
- Soil stockpiles must be stabilized and protected with sediment trapping measures.
- Linear construction activities such as right-of-way and easement clearing, roadway development, pipelines, and trenching for utilities, shall be conducted to meet the soil stabilization timeframe requirements. Contractors shall install the bedding materials, roadbeds, structures, pipelines, or utilities and re-stabilize the disturbed soils so that the 7-day requirements are met:
- Suggested BMPs:
  - \_ Temporary seeding
  - \_ Permanent seeding
  - \_ Mulching
  - \_ Rolled erosion control products
  - \_ Sodding
  - \_ Topsoiling
  - \_ Polyacrylamide for soil erosion protection
  - \_ Surface roughening
  - \_ Surface water control
  - \_ Dust control

**Element #5: Protect slopes**

- The General Permit prohibits upslope runoff from flowing down fill slopes. Contain fill runoff with temporary berms and in pipes, slope drains, or stabilized channels.
- Design, construct, and phase cut and fill slopes in a manner that will minimize erosion.
- Consider soil type and its potential for erosion.
- Reduce slope runoff velocities by reducing continuous length of slope with benches and diversions, reduce slope steepness, and roughen slope surface.
- Divert upslope drainage and run-on waters with interceptors at top of slope. Surface water from offsite should be handled separately from surface water generated on the site. Diversion of offsite surface water around the site may be a viable option. Diverted flows must be redirected to the natural drainage location at or before the property boundary.

- Provide drainage to remove ground water intersecting the slope surface of exposed soil areas.
- Excavated material shall be placed on the uphill side of trenches, consistent with safety and space considerations.
- Stabilize soils on slopes, as specified in Element #4.
- Suggested BMPs:
  - \_ Temporary seeding
  - \_ Permanent seeding
  - \_ Surface roughening
  - \_ Temporary diversions
  - \_ Temporary berms
  - \_ Pipe slope drains
  - \_ Level lip spreader
  - \_ Rock check dams
  - \_ Commercial check dams

**Element #6: Protect drain inlets**

- Storm drain inlets operable during construction shall be protected so that surface water runoff does not enter the conveyance system without first being filtered or treated to remove sediment.
- Approach roads shall be kept clean.
- Inlets should be inspected weekly at a minimum and daily during storm events. Inlet protection devices should be cleaned or removed and replaced before six inches of sediment can accumulate.
- Suggested BMPs:
  - \_ Drop inlet protection

**Element #7: Convey stormwater in a non-erosive manner**

- Points of discharge and receiving streams shall be protected from erosion due to increases in the volume, velocity, and peak flow rate of surface water runoff from the project site.
- Design and stabilize any stormwater conveyance for expected flows.
- Consider any local government requirements for stormwater management.
- Suggested BMPs:
  - Outlet protection
  - \_ Level lip spreader
  - \_ Riprap
  - \_ Rock check dams
  - \_ Surface water controls
  - \_ Rolled erosion control products



### **Element #8: Control other pollutants**

- All pollutants, including waste materials and demolition debris, that occur on site during construction shall be handled and disposed of in a manner that does not cause contamination of surface water. Woody debris may be chopped and spread on site.
- Cover, containment, and protection from vandalism shall be provided for all chemicals, liquid products, petroleum products, and non-inert wastes present on the site.
- Maintenance and repair of heavy equipment and vehicles involving oil changes, hydraulic system drain down, solvent and de-greasing cleaning operations, fuel tank drain down and removal, and other activities which may result in discharge or spillage of pollutants to the ground or into surface water runoff must be conducted using spill prevention measures, such as drip pans. Contaminated surfaces shall be cleaned immediately following any discharge or spill incident. Emergency repairs may be performed on-site using temporary plastic placed beneath and, if raining, over the vehicle.
- Wheel wash or tire bath wastewater shall be discharged to a separate on-site treatment system or to the sanitary sewer.
- Application of agricultural chemicals including fertilizers and pesticides shall be conducted in a manner and at application rates that will not result in loss of chemical to surface water runoff. Manufacturers' recommendations for application rates and procedures shall be followed.
- BMPs shall be used to prevent or treat contamination of surface water runoff by pH modifying sources. These sources include bulk cement, cement kiln dust, fly ash, new concrete washing and curing waters, waste streams generated from concrete grinding and sawing, exposed aggregate processes, and concrete pumping and mixer washout waters.

### **Element #9: Control dewatering**

- Foundation, vault, and trench dewatering water shall be discharged into a controlled conveyance system prior to discharge to a sediment pond. Channels must be stabilized, as specified in Element #8.
- Clean, non-turbid dewatering water, such as well-point ground water, can be discharged to systems tributary to state surface waters, as specified in Element #7, provided the dewatering flow does not cause erosion or flooding of receiving waters. These clean waters should not be routed through surface water sediment ponds.
- Highly turbid or contaminated dewatering water from construction equipment operation, work inside a cofferdam shall be handled separately from surface water.
- Other disposal options, depending on site constraints, may include:
  1. Infiltration;
  2. Transport off-site in vehicle, such as a vacuum flush truck, for legal disposal in a manner that does not pollute state waters;
  3. On-site treatment using chemical treatment or other suitable treatment technologies;
  4. Sanitary sewer discharge with local sewer utility approval; or
  5. Use of a dewatering bag with outfall to a ditch or swale for small volumes of localized dewatering.

### **Element #10: Maintain BMPs**

- Temporary and permanent erosion and sediment control BMPs shall be maintained and repaired as needed to assure continued performance of their intended function. Maintenance and repair shall be conducted in accordance with BMPs.
- Sediment control BMPs shall be inspected weekly or after each storm of 0.5 inches or more.
- Temporary erosion and sediment control BMPs should be removed within 30 days after final site stabilization is achieved or after the temporary BMPs are no longer needed. Trapped sediment shall be removed or stabilized on site. Disturbed soil resulting from removal of BMPs or vegetation shall be permanently stabilized.
- Maintenance should be included as a separate bid item for each BMP, where applicable.

### **Element #11: Manage the project**

- Phasing of Construction - Development projects shall be phased in order to prevent the transport of sediment from the development site during construction, unless the project engineer can demonstrate that construction phasing is infeasible. Revegetation of exposed areas and maintenance of that vegetation shall be an integral part of the clearing activities for any phase.

Clearing and grading activities for developments shall be permitted only if conducted pursuant to an approved site development plan (e.g., subdivision approval) that establishes areas of clearing, grading, cutting, and filling. When establishing clearing and grading areas, consideration should be given to minimizing removal of existing trees and disturbance and compaction of native soils. Any areas required to preserve critical or sensitive areas, and buffers, shall be delineated on both the plans and the site.

- Coordination with Utilities and Other Contractors - The primary project manager shall evaluate, with input from utilities and other contractors, the surface water management requirements for the entire project, including the utilities, when preparing the SCP.
- Inspection and Monitoring - All BMPs shall be inspected, maintained, and repaired as needed to assure continued performance of their intended function.

Whenever inspection and/or monitoring reveals that the BMPs identified in the SCP are inadequate, the SCP shall be modified, as appropriate, in a timely manner.

- Reporting - Report spillage or discharge of pollutants within 24-hours.
- Equipment Maintenance - Maintenance and repair of heavy equipment and vehicles involving oil changes, hydraulic system drain down, solvent and de-greasing cleaning operations, fuel tank drain down and removal, and other activities which may result in discharge or spillage of pollutants to the ground or into surface water runoff must be conducted using spill prevention measures, such as drip pans. Contaminated surfaces shall be cleaned immediately following any discharge or spill incident. Contaminated soil must be disposed of properly. Emergency repairs may be performed on-site using temporary plastic placed beneath and, if raining, over the vehicle.
- Maintenance of the SCP - The SCP shall be retained on-site. The SCP shall be modified whenever there is a significant change in the design, construction, operation, or maintenance of any BMP. The DEP must be notified of any changes to the Construction SWPP. Depending on the significance of the revision, a permit modification may need to be submitted to the DEP.

**Element #12: Stabilization**

The construction site should be stabilized as soon as possible after completion. Establishment of final cover must be initiated no later than 7 days after reaching final grade. A Notice of Termination must be filed with the DEP when the site reaches final stabilization. Final stabilization means that all soil-disturbing activities are completed, and that either a permanent vegetative cover with a density of 70% or greater has been established or that the surface has been stabilized by hard cover such as pavement or buildings... It should be noted that the 70% requirement refers to the total area vegetated and not just a percent of the site.

## *Section 3*

# *Checklists for Sediment Control Plans*

---

The SCP typically consists of two parts: a narrative and the drawings. The following two sections describe in general terms the contents of the narrative and the drawings. For more specific information to comply with the General Permit see the instructions to complete a site Registration application form following this section.

Several checklists are included in this manual that can be used as a quick reference to determine if all the major items are included in the SCP.

### **Narrative**

The following topic headings are guideline to be used when preparing the SCP narrative.

- Project description – Describe the nature and purpose of the construction project. Include the size of the project area, any increase in existing impervious area, the area disturbed, and the volumes of grading cut and fill that are proposed.
- Existing site conditions – Describe the existing topography, vegetation, and drainage. Include a description of any structures or development on the parcel including the area of existing impervious surfaces.
- Adjacent areas – Describe adjacent areas, including streams, lakes, wetlands, residential areas, and roads that might be affected by the construction project. Provide a description of the downstream drainage leading from the site to the receiving body of water.
- Critical areas – Describe areas on or adjacent to the site that are classified as critical areas. Describe special requirements for working near or within these areas.
- Soil – Describe the soils on the site, giving such information as soil names, mapping unit, erodibility, settleability, permeability, depth, texture, and soil structure.
- Potential erosion problem areas – Describe areas on the site that have potential erosion problems.
- Twelve (12) elements – Describe how the SCP addresses each of the 12 required elements. Include the type and location of BMPs used to satisfy the each element. If a sediment basin or trap of the required volume cannot be constructed provide a written justification and explain in detail what other sediment and erosion controls will be used in its place.
- Construction phasing – Describe the construction sequence of events and proposed construction phasing.
- Construction schedule – Provide a relative construction schedule. It is not necessary to provide exact dates but rather describe in relative terms when each construction phase will take place and how and where each planned sediment and erosion control device or practice will be installed.
- Engineering calculations – Attach any calculations made for the design of such items as sediment ponds, diversions, and waterways, as well as calculations for runoff and surface water detention design (if applicable). Engineering calculations for permanent structures must bear the signature and stamp of an Engineer licensed in the State of West Virginia. References shall be provided for all variables used.

## Drawings

Because contractors seldom will see the SWPPP, the Contract Drawings should include all of the critical provisions of the SWPPP.

Each set of Contract Drawings should have at a minimum the following information.

- Name of the project and owner, address; Parcel Number or other identifying mark; and scale.
- Vicinity Map – Provide a map locating the site in relation to the surrounding area and roads.
- Number of sheets with index.
- **Site map** – Provide a site map(s) showing the following features. The site map requirements may be met using multiple plan sheets for ease of legibility.

1. Standard notes that summarize the critical portions of the SCP. Notes addressing construction sequencing and scheduling must be included on the drawings.
2. Show project limits.
3. The direction of north in relation to the site.
4. Existing structures and roads, if present.
5. The boundaries of and label the different soil types.
6. Areas of potential erosion problems.
7. Any on-site and adjacent critical areas, their buffers, and FEMA base flood boundaries.
8. Existing contours and drainage basins and the direction of flow for the different drainage areas.
9. Final grade contours and developed condition flow paths and drainage basins.
10. Areas that are to be cleared and graded.
11. Existing unique or valuable vegetation and the vegetation that is to be preserved.
12. Cut and fill slopes indicating top and bottom of slope.
13. Stockpile, waste storage, and vehicle storage/maintenance areas.
14. Total cut and fill quantities and the disposal method and location of excess material. All existing and proposed utilities and any associated easements.
15. Proposed permanent structures including roads and parking areas.

• **Conveyance systems** – Show on the site map(s) the following temporary and permanent onsite and offsite conveyance features:

1. Locations for existing and permanent swales, diversions, or ditches.
2. Drainage pipes, berms, ditches, or diversions associated with erosion and sediment control and surface water management.
3. Temporary and permanent pipe inverts and minimum slopes.
4. Grades, dimensions, and direction of flow in all ditches and swales, culverts, and pipes.
5. Details for bypassing offsite runoff around disturbed areas.
6. Locations and outlets of any dewatering systems.

• **Location of stormwater management structures** – Show on the site map the locations of any stormwater management structures.

• **Erosion and sediment control practices** – Show on the site map the following erosion and sediment control practices:

1. The location of sediment basins/trap(s), pipes and structures.

2. Dimension basin berm widths and inside and outside pond slopes.
  3. The trap/pond storage required and the depth, length, and width dimensions.
  4. Typical section views through pond and outlet structure.
  5. Typical details of riser and other outlet devices.
  6. Stabilization technique details for basin inlets and outlets.
  7. Temporary and permanent seeding and mulching specifications. Seeding timeframes.
  8. Temporary stabilization methods and timeframe for berms, diversions and slopes.
  9. Rock specifications and detail for outlet protection, rock check dam, and any other device used.
  10. Construction drawings for each sediment and erosion control device used on the project. Include construction specifications for each device used.
  11. The construction entrance location and a stabilization detail.
- Other non-traditional practices--Any structural practices used that are not referenced in this manual should be explained and illustrated with detailed drawings.
  - Other pollutant BMPs--Indicate on the site map the location of BMPs to be used for the control of pollutants other than sediment.

# Construction Sediment Control Plan Checklist

---

Project Name: \_\_\_\_\_

Address: \_\_\_\_\_

## Section I – SCP Narrative

### 1. Project Description

- \_\_\_ A. Total Project Area
- \_\_\_ B. Total proposed impervious area.
- \_\_\_ C. Total proposed area to be disturbed.
- \_\_\_ D. Total volumes of proposed cuts/fill.

### 2. Existing Site Conditions

- \_\_\_ A. Description of the existing topography.
- \_\_\_ B. Description of the existing vegetation.
- \_\_\_ C. Description of the existing drainage.

### 3. Adjacent Areas

- \_\_\_ A. Description of adjacent areas which may be affected by site disturbance
  - \_\_\_ 1. Streams
  - \_\_\_ 2. Lakes
  - \_\_\_ 3. Wetlands
  - \_\_\_ 4. Residential areas
  - \_\_\_ 5. Roads
  - \_\_\_ 6. Ditches, pipes, culverts
  - \_\_\_ 7. Other
- \_\_\_ B. Description of the downstream drainage path leading from the site to the receiving body of water. (Minimum distance of 1/4 mile.)

### 4. Critical Areas

- \_\_\_ A. Description of critical areas that are on or adjacent to the site.
- \_\_\_ B. Description of special requirements for working in or near critical areas.

### 5. Soils

- \_\_\_ A. Description of on-site soils.
  - \_\_\_ 1. Soil name(s)
  - \_\_\_ 2. Soil mapping unit
  - \_\_\_ 3. Erodibility
  - \_\_\_ 4. Settleability
  - \_\_\_ 5. Permeability
  - \_\_\_ 6. Depth
  - \_\_\_ 7. Texture

\_\_\_ 8. Soil structure

## **6. Erosion Problem Areas**

\_\_\_ A. Description of potential erosion problems on site.

## **7. Construction Stormwater Pollution Prevention Elements**

\_\_\_ A. Describe how each of the Construction Stormwater Pollution Prevention Elements has been addressed through the SCP.

\_\_\_ B. Identify the type and location of BMPs used to satisfy the required element.

\_\_\_ C. Written justification identifying the reason an element is not applicable to the proposal.

12 Required Elements - Construction Stormwater Pollution Prevention Plan:

- \_\_\_ 1. Mark Clearing Limits
- \_\_\_ 2. Establish Construction Access
- \_\_\_ 3. Install Sediment Controls
- \_\_\_ 4. Stabilize Soils
- \_\_\_ 5. Protect Slopes
- \_\_\_ 6. Protect Drain Inlets
- \_\_\_ 7. Convey stormwater in a non-erosive manner
- \_\_\_ 8. Control Other Pollutants
- \_\_\_ 9. Control Dewatering
- \_\_\_ 10. Maintain BMPs
- \_\_\_ 11. Manage the Project
- \_\_\_ 12. Stabilization

## **8. Construction Phasing**

\_\_\_ A. Construction sequence

\_\_\_ B. Construction phasing (if proposed)

## **9. Construction Schedule**

\_\_\_ A. Provide a proposed construction schedule.

\_\_\_ B. Wet Season Construction Activities

- \_\_\_ 1. Proposed wet season construction activities.
- \_\_\_ 2. Proposed wet season construction restraints for environmentally sensitive/critical areas.

## **11. Engineering Calculations**

\_\_\_ A. Provide Design Calculations.

- \_\_\_ 1. Sediment ponds/traps
- \_\_\_ 2. Diversions
- \_\_\_ 3. Waterways
- \_\_\_ 4. Runoff/stormwater calculations



## ***Construction Sediment Control Plan Checklist***

---

### **Section II - Erosion and Sediment Control Plans**

#### **1. General**

- A. Vicinity Map
- B. Address, Parcel # and Street names labels
- C. Erosion and Sediment Control Notes

#### **2. Site Plan**

- A. Legal description of subject property.
- B. North Arrow
- C. Indicate boundaries of existing vegetation, e.g. tree lines, pasture areas, etc.
- D. Identify and label areas of potential erosion problems.
- E. Identify any on-site or adjacent critical areas and associated buffers.
- F. Identify FEMA base flood boundaries
- G. Show existing and proposed contours.
- H. Indicate drainage basins and direction of flow for individual drainage areas.
- I. Label final grade contours and identify developed condition drainage basins.
- J. Delineate areas that are to be cleared and graded.
- K. Show all cut and fill slopes indicating top and bottom .

#### **3. Conveyance Systems**

- A. Designate locations for swales, interceptor trenches, or ditches.
- B. Show all temporary and permanent drainage pipes, ditches, or cut-off trenches required for erosion and sediment control.
- C. Provide minimum slope and cover for all temporary pipes or call out pipe inverts.
- D. Show grades, dimensions, and direction of flow in all ditches, swales, culverts and pipes.
- E. Provide details for bypassing offsite runoff around disturbed areas.
- F. Indicate locations and outlets of any dewatering systems.

#### **4. Location of Stormwater Management Structures**

- A. Identify location of any stormwater management structures.

#### **5. Erosion and Sediment Control Measures**

- A. Show the locations of sediment trap(s), pond(s), pipes and structures.
- B. Dimension pond berm widths and inside and outside pond slopes.
- C. Indicate the trap/pond storage required and the depth, length, and width dimensions.
- D. Provide typical section views through pond and outlet structure.
- E. Provide typical details of gravel cone and standpipe, and/or other filtering devices.
- F. Detail stabilization techniques for outlet/inlet.
- G. Detail control/restrictor device location and details.
- H. Specify mulch and/or recommended cover of berms and slopes.
- I. Provide rock specifications and detail for rock check dam(s), if applicable.
- J. Specify spacing for rock check dams as required.

## ***Construction Sediment Control Plan Checklist***

---

- K. Provide front and side sections of typical rock check dams.
- L. Indicate the locations and provide details and specifications for silt fabric.
- M. Locate the construction entrance and provide a detail.

### **6. Detailed Drawings**

- A. Any structural practices used that are not referenced in the Manual should be explained and illustrated with detailed drawings.

### **7. Other Pollutant BMPs**

- A. Indicate on the site plan the location of BMPs to be used for the control of pollutants other than sediment, e.g. concrete wash water.

### **8. Monitoring**

- A. Describe inspection reporting responsibility, documentation, and filing.

# CHAPTER 3

STANDARD GUIDELINES AND SPECIFICATIONS

# 3.01 - PRESERVING EXISTING VEGETATION

---

## ***Introduction***

This practice is to preserve the existing natural vegetation thereby reducing erosion wherever practicable. Limiting the amount of disturbance on a construction site is the single most effective method for reducing erosion. For example, trees can hold up to about 50 percent of all rain that falls during a storm. Up to 20-30 percent of this rain may never reach the ground but is taken up by the tree or evaporates. Raindrop erosion is also prevented. Vegetation cools the ground and reduces soil evaporation. Removing natural vegetation and destroying the existing soil profile is one of the greatest causes of increased runoff and subsequent flooding. In urbanizing areas such as the Eastern Panhandle, preserving existing vegetation can be one the most important practice contributing to clean water.

Natural vegetation should be preserved as much as possible but especially on critical areas such as: steep slopes, areas adjacent to perennial and intermittent watercourses or swales or wetlands, and on building sites in wooded areas.

It doesn't make sense to destroy all the trees in a subdivision and then name one of the new streets Shady Oak Lane.

## ***Design and Installation Specifications***

Natural vegetation can be preserved in natural clumps or as individual trees, shrubs and vines.

The preservation of individual plants is more difficult because heavy equipment is generally used to remove unwanted vegetation. The points to remember when attempting to save individual plants are:

- Is the plant worth saving? Consider the location, species, size, age, vigor, and the work involved. Check you're your local government. They may have ordinances to save natural vegetation and trees.
- Fence or clearly mark areas around trees that are to be saved. It is preferable to keep all disturbances away from the trees at least as far out as the drip line. (see drawing)

Plants need protection from three kinds of injuries:

**Construction Equipment** - This injury can be above or below the ground level. Damage results from scarring, cutting of roots, and

compaction of the soil. Placing a fenced buffer zone around plants to be saved prior to construction can prevent construction equipment injuries.

**Grade Changes** - Changing the natural ground level will alter grades, which affects the plant's ability to obtain the necessary air, water, and minerals. Minor fills usually do not cause problems although sensitivity between species does vary and should be checked. Trees can tolerate fill of 6 inches or less. For shrubs and other plants, the fill should be less.

When there are major changes in grade, it may become necessary to supply air to the roots of plants. If fill has to be placed over the root system, place a layer of gravel and a tile system over the roots before the fill is made. The tile system should be laid out on the original grade leading from a dry well around the tree trunk. The system should then be covered with small stones to allow air to circulate over the root area.

Lowering the natural ground level can also seriously damage trees and shrubs. The highest percentage of the plant roots are in the upper 12 inches of the soil and cuts of only 2-3 inches can cause serious injury. To protect the roots it may be necessary to terrace the immediate area around the plants to be saved. If roots are exposed, construction of retaining walls may be needed to keep the soil in place. Plants can also be preserved by leaving them on an undisturbed, gently sloping mound. To increase the chances for survival, it is best to limit grade changes and other soil disturbances to areas outside the drip line of the plant.

**Excavations** - Protect trees and other plants when excavating for drainfields, power, water, and sewer lines. Where possible, the trenches should be routed around trees and large shrubs. When this is not possible, it is best to tunnel under them. This can be done with hand tools or with power augers. If it is not possible to route the trench around plants to be saved, then the following should be observed:

- Cut as few roots as possible. When you have to cut, cut clean. Paint cut root ends with a wood dressing like asphalt base paint.
- Backfill the trench as soon as possible.
- Tunnel beneath root systems as close to the center of the main trunk to preserve the important feeder roots.

Trees damaged or stressed by construction may die slowly or become more susceptible to attack from disease or insects. Failure to properly protect trees may result in expensive removal costs post construction.

**Problem trees:** The following trees are more susceptible to damage than others: beech, yellow poplar, Dogwood, hickory, birch, some oaks, most maples, and all conifers. These trees do not readily adjust to changes in the immediate environment and special care should be taken to protect these trees.

Maples and willows have water-seeking roots. These can cause trouble in sewer lines and infiltration fields. On the other hand, they thrive in high moisture conditions that other trees would not.

***Minimum Tree Protection Measures***

Active tree protection shall consist of, at a minimum, establishing a tree protection zone around each tree or grouping of trees by the installation of fencing at the outer edges of the critical root zone. Protecting the roots of a tree is the most important aspect of tree preservation on a construction project. This root zone can extend two to three times the radius of the drip line.

Despite this the tree protection zone is usually placed along the drip line. Some experts recommend a tree protection root zone calculated as one foot to one and half feet of radius for each inch of tree diameter at breast height. While this is a significant amount of space, if the tree is valuable, the root protection zone should extend to the edge all of the roots. If you want to protect the lower branches, the barrier must be just outside the drip line.

Tree protection fencing and tree protection area signs shall be installed prior to any land disturbance activity or building activity. Tree protection fencing should be at least four feet high and should be installed with either sturdy wooden or metal fence posts around the tree protection zone. Tree protection fencing must remain in good condition throughout the development and construction processes and should only be removed after construction has ceased.

Tree roots need oxygen so it is important to limit compaction around trees. If there is ANY disturbance with the root zone, the tree protection area should be mulched with a minimum of three inches and not more than eight inches of organic mulch such as pine straw, wood chips, tree leaves, or compost.

Allow NO storage, NO heavy equipment, NO machinery, NO trenching, NO digging, NO driving, NO lounging of workers in this area. The area within the protection zone must be off limits to ALL activity.

The Engineer or owner may require the installation of additional tree protection measures to insure survivability of conserved trees.

***Materials***

1. Protective fencing should be installed anytime existing natural vegetation is to be preserved.
2. Protective fencing is designated as the materials used to protect the root zones of trees. Three basic types of protective fencing materials can be used. Type A and Type B are typical applications and shall be installed where damage potential to a tree root system is high, while Type C shall be installed where damage potential is minimal.

3. The specific type of protective fencing for the work shall be as indicated on the Drawings.
4. Type C fencing shall be replaced by Type A or Type B fencing as directed by the Engineer or designated representative if it fails to perform the necessary function.

- a. Type A Chain Link fence (Typical Application-high potential damage)

Type A protective fencing shall be installed in accordance with the Division of Highways Standard for Chain Link Fence and shall consist of a minimum five-foot high chain link fencing with tubular steel support poles or "T" posts.

- b. Type B Wood Fence (Typical Application-high potential damage)

Type B protective fencing shall consist of any vertical planking attached to 2x4-inch horizontal stringers that are supported by 2x4-inch intermediate vertical supports and a 4x4-inch at every fourth vertical support.

- c. Type C Other Materials (Minimal potential damage)

The following materials may be permitted as alternates for limited or temporary applications and where tree damage potential is minimal:

- (1) High visibility plastic construction fencing. The Standard for SAFETY FENCE in this manual can be used for this specification.
- (2) Other approved equivalent restraining material.

The fencing materials, identified in (1) and (2) above, shall be supported by steel pipe, tee posts, U posts or 2" x 4" timber posts that are a minimum of 5-1/2 feet in height and spaced no more than 8 feet on centers. The fabric shall be secured to post by bands or wire ties.

### ***Maintenance***

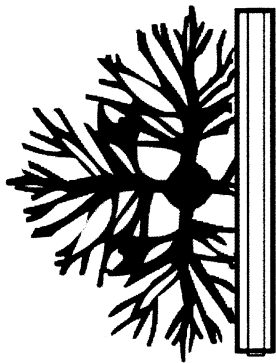
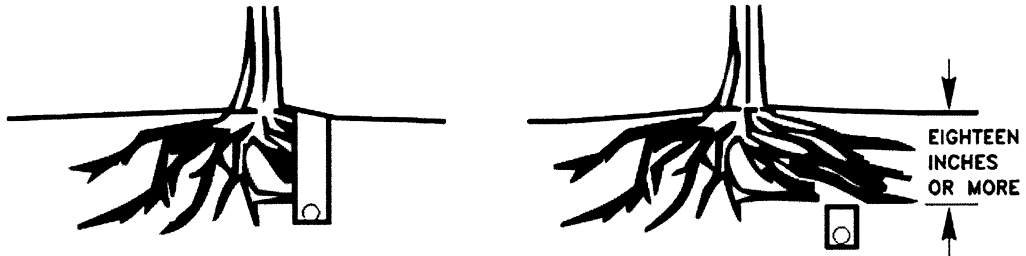
Inspect flagged and/or fenced areas regularly to make sure flagging or fencing has not been removed or damaged. If the flagging or fencing has been damaged or visibility reduced, it shall be repaired or replaced immediately and visibility restored.

If tree roots have been exposed or injured, "prune" cleanly with an appropriate pruning saw or loppers directly above the damaged roots and recover with native soils. Treatment of sap flowing trees (pine, soft maples) is not advised as sap forms a natural healing barrier.

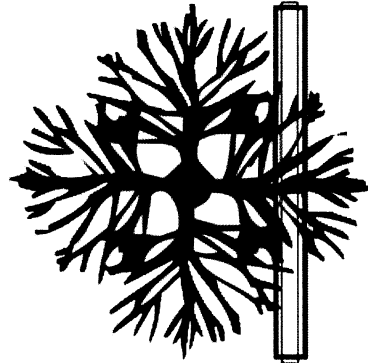
FIGURE 3.01.1

# *PRESERVING NATURAL VEGETATION*

## *TRENCHING VS TUNNELING*



DESTRUCTION OF FEEDER ROOTS  
WILL PROBABLY KILL THE TREE



TUNNELING UNDER THE TREE WILL  
PRESERVE ANY FEEDER ROOTS

SOURCE: US ACOE



FIGURE 3.01.2

# TREE PROTECTION ZONES

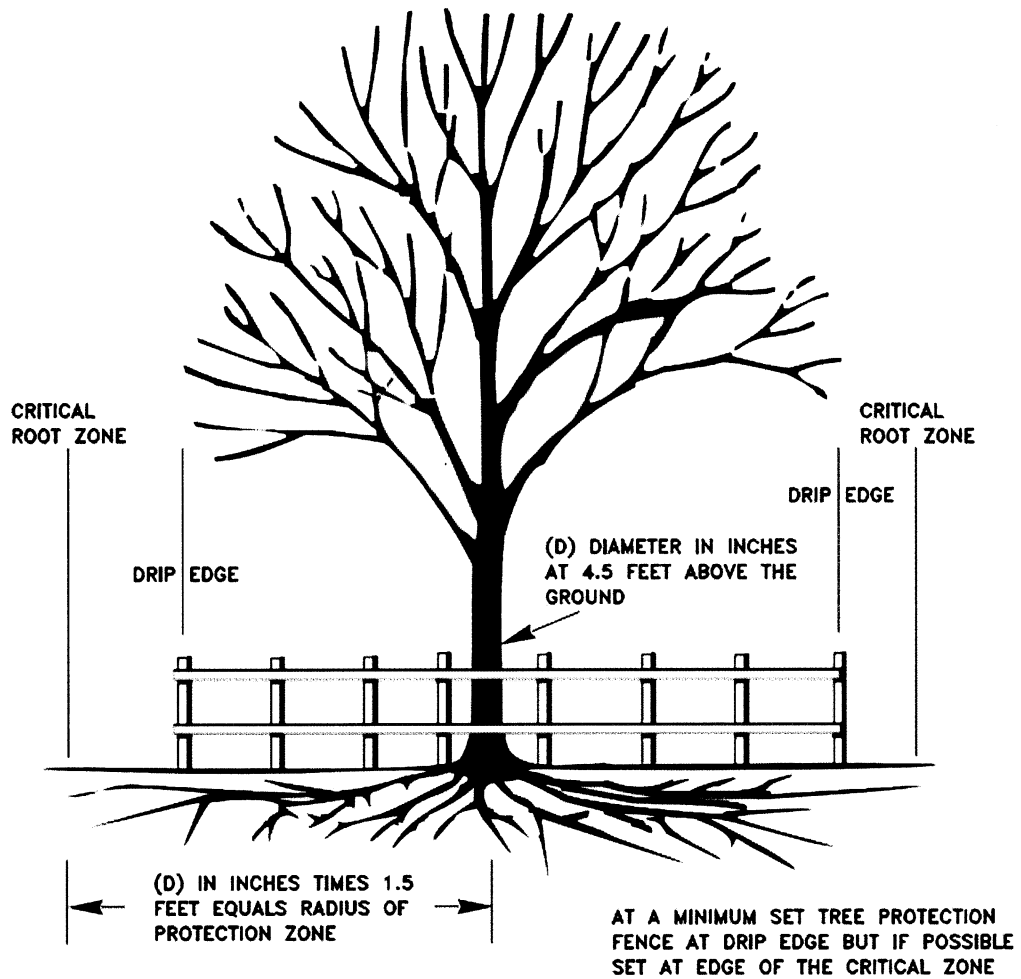
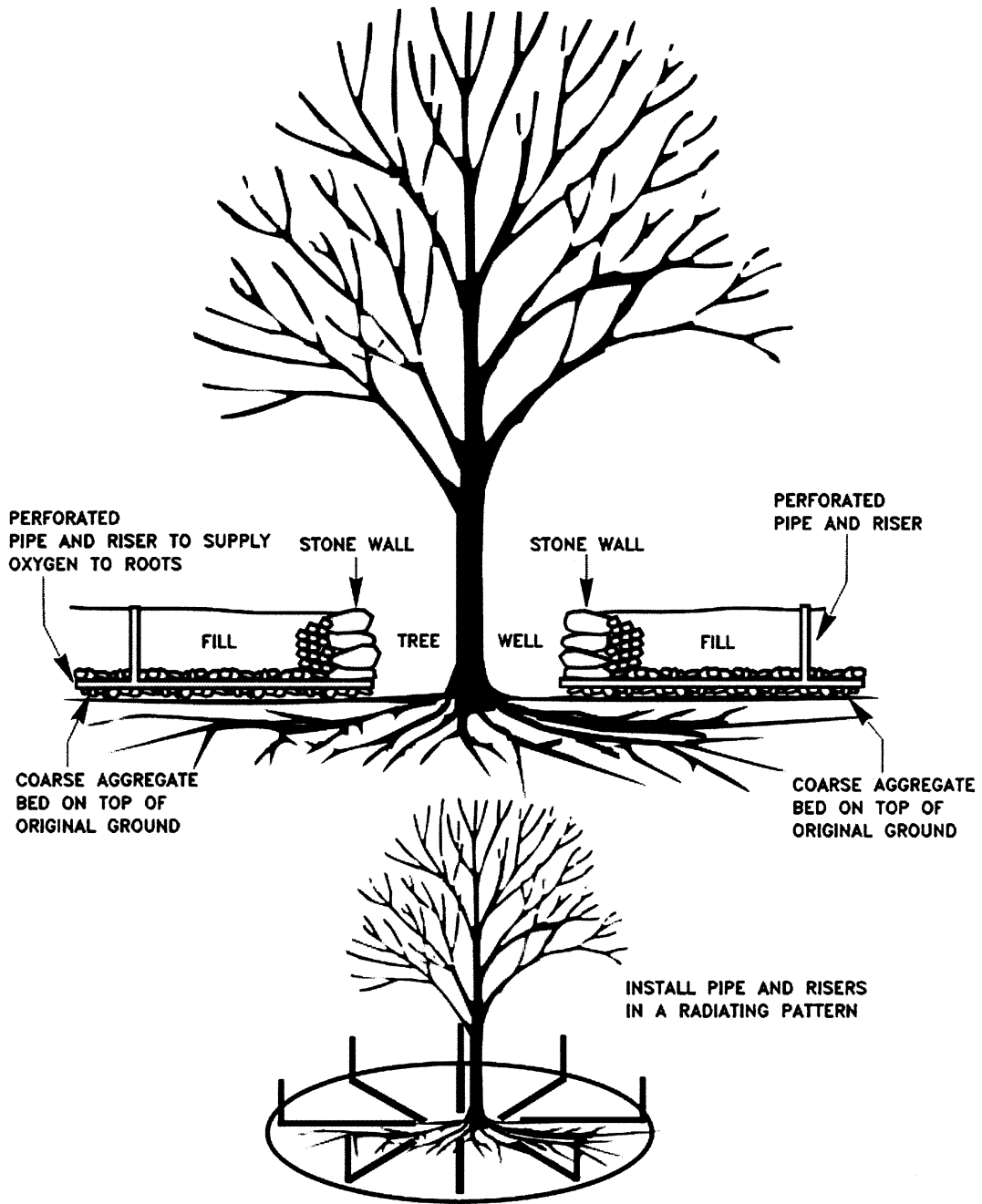


FIGURE 3.01.3

# TREE WELL WHEN FILLING OVER TREE ROOTS



# 3.02 - STABILIZED CONSTRUCTION ENTRANCE

---

**Introduction** Large quantities of mud can be tracked onto public and private roads causing dangerous driving conditions and muddy runoff when it rains. Construction entrances are stabilized to reduce the amount of sediment transported onto paved roads by vehicles or equipment by constructing a stabilized pad of stone at entrances to construction sites.

**Conditions Where Practice Applies** Stabilized Construction Entrances shall be installed wherever construction traffic enters and leaves a site.

- Design Criteria**
1. Use 2-4 inch stone for low volume entrances, larger stone (4-6 inch) for heavy use or material delivery entrances.
  2. Length is as required, but not less than 70 feet (except on a single residence lot where a 30 foot minimum length would apply).
  3. Thickness should be not less than 6 inches.
  4. The width shall be a minimum of 10 feet, but not less than the full width at points where ingress or egress occurs.
  5. Geotextile fabric shall be placed over the entire area prior to the placing of stone.
  6. All surface water flowing or diverted toward construction entrances shall be piped across the entrance. If a culvert is impractical, a mountable berm with 5:1 slopes shall be used.
  7. If necessary, divert any water running down access road to a sediment trap located on either side of the Stabilized Construction Entrance.

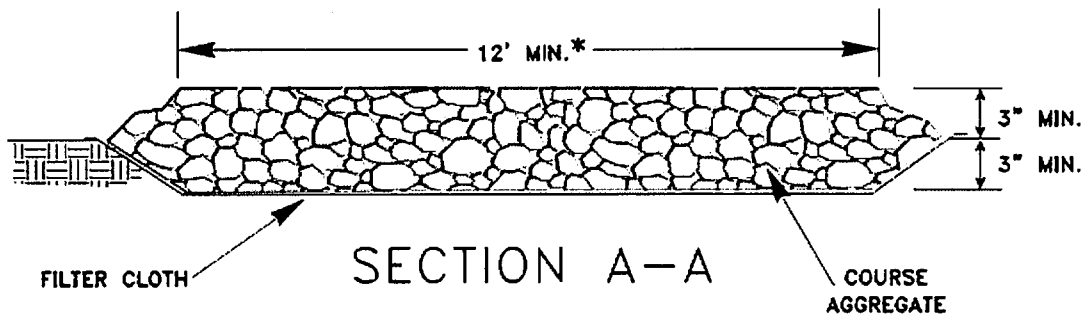
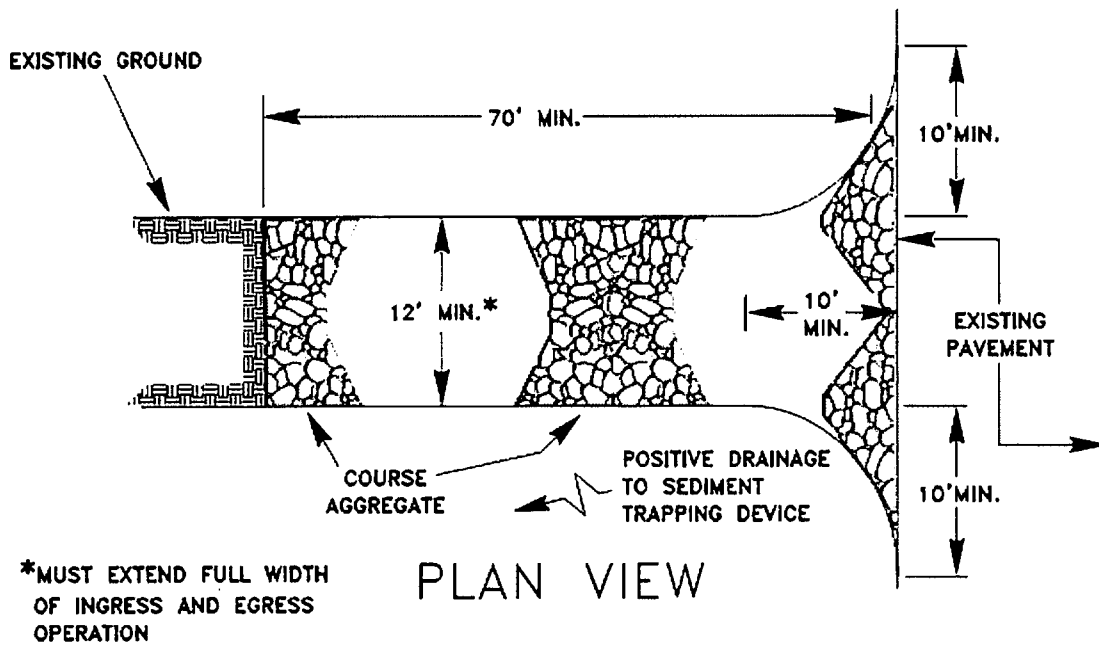
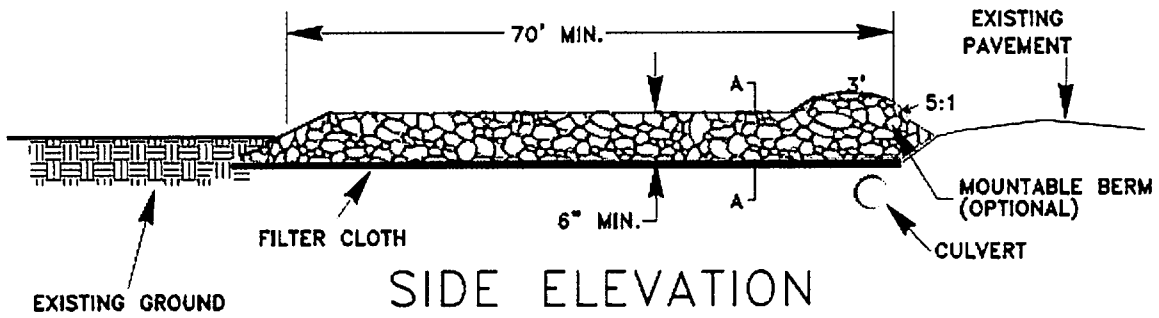
**Maintenance** The entrance shall be maintained in a condition that will prevent tracking or flowing of sediment onto public rights-of-way. This may require periodic top dressing with additional stone as conditions demand and repair and/or cleanout of any measures used to trap sediment. All sediment spilled, dropped, washed or tracked onto public rights-of-way must be removed immediately.

Wheels on all vehicles shall be cleaned to remove sediment prior to entrance onto public rights-of-way. If washing is required, it shall be done on an area stabilized with stone and which drains into approved sediment trapping device. If the street is washed precautions must be taken to prevent muddy water from running into waterways or storm sewers.

Inspection and needed maintenance should be provided daily but at a minimum every seven days and after every rain of 0.5 inch or greater.

FIGURE 3.02.1

# STONE CONSTRUCTION ENTRANCE



# 3.03 - TEMPORARY CONSTRUCTION ROAD, WORK AND PARKING AREA STABILIZATION

---

**Introduction** The temporary stabilization of access roads, haul roads, parking areas, laydown, material storage and other onsite vehicle transportation routes with stone immediately after grading. This practice is used to reduce the erosion and subsequent regrading of temporary and permanent roadbeds, work areas and parking areas rutted by construction traffic during wet weather. Provides easier access in all weather and reduces tracking mud onto public roads.

**Conditions Where Practice Applies** All temporary work areas on a construction site where vehicular traffic will occur.

- Construction Specifications**
1. Temporary roads shall follow the contour of the natural terrain to the extent possible. Slopes should not exceed 15 percent.
  2. Temporary parking areas should be located on naturally flat areas to minimize grading. Grades should be sufficient to provide drainage but should not exceed 4 percent.
  3. Roadbeds should be at least 14 feet wide for one-way traffic and 20 feet wide for two-way traffic. Haul roads should be at least 30 feet wide.
  4. All cuts and fills should be 2:1 or flatter.
  5. Drainage ditches and culverts shall be provided as needed.
  6. The roadbed or parking surface shall be cleared of all vegetation, roots and other objectionable material.
  7. A 6-inch course of crushed aggregate shall be applied immediately after grading. Geotextile fabric should be applied to the roadbed for additional stability. In heavy duty traffic situations, stone should be placed at an 8 to 10 inch depth to avoid excessive maintenance.
  8. Stabilize disturbed areas not covered with stone immediately after installation with appropriate temporary or permanent vegetation according to the applicable standards and specifications contained in this manual.
  9. Also see, access road section, for water control practices.

**Maintenance** Inspect and perform needed maintenance at a minimum once every seven

calendar days and within 24 hours after any storm event greater than 0.5 inches of rain per 24 hour period.

Both temporary and permanent roads, laydown and work areas and parking areas may require periodic top dressing with new gravel.

Seeded areas adjacent to the roads and parking areas should be checked periodically to ensure that a vigorous stand of vegetation is maintained.

Roadside ditches and other drainage structures should be checked regularly to ensure that they do not become clogged with silt or other debris.

# 3.04 - SAFETY FENCE

**Introduction** Protective fencing should be installed to prevent access to potentially hazardous areas of a construction site.

**Conditions Where Practice Applies** Applicable to any control measure or series of measures, which can be considered unsafe by virtue of potential for access by the public. The designer, developer, and contractor should always be sure that the most appropriate type of fence is utilized for a particular need.

- Construction Specifications**
1. Safety fences should be located so as to create a formidable barrier to undesired access, while allowing for the continuation of necessary construction operations.
  2. Safety fences are most applicable to the construction of traps and dams. In use with those structures, safety fences should be located far enough beyond the outer toe of the embankment to allow for the passage of maintenance vehicles. Fences should not be installed across the slope of a dam or dike.
  3. Signs noting potential hazards such as "DANGER" or "HAZARDOUS AREA --KEEP OUT" should be posted and easily seen by anyone approaching the protected area.
  4. Plastic (polyethylene) fence may be used as safety fencing, primarily in situations where the need is for a temporary barrier. The fence should meet the physical requirements noted in Table 3.04.1.

<b>Table 3.04.1 Physical properties of plastic safety fence</b>		
<u>Physical property</u>	<u>Test</u>	<u>Requirements</u>
Recommended color	N/A	International Orange
Tensile yield	ASTM D638	Average 2,000 lbs.
Ultimate tensile strength	ASTM D638	Average 2,900 lbs. per 4 ft. width
Elongation at break(%)	ASTM D638	Greater than 1000%
Chemical resistance	N/A	Inert to most chemicals/acids

5. Safety fences should be installed prior to the sediment control measure becoming accessible.
6. Applicable warning signs noting hazardous conditions must be installed immediately upon installation of safety fence.

7. Chain link fence should be used for permanent structures (greater than one year).

***Maintenance***

Safety fence shall be checked regularly for weather-related or other damage. Any necessary repairs must be made immediately.

Care should be taken to secure all access points (gates) at the end of each working day. All locking devices must be repaired or replaced as necessary.



## 3.05 - ROCK CHECK DAMS

---

### ***Introduction***

Small temporary stone dams can be constructed across a waterway to reduce the velocity of stormwater flows, thereby reducing erosion of the channel and trapping sediment. This practice is the replacement for the traditionally misused hay/straw bales and silt fence ditch checks. Constructing a small dugout trap upstream of the structure can enhance the sediment trapping efficiency.

### ***Conditions Where Practice Applies***

This practice, utilizing a combination of stone sizes, is limited to use in small open channels that drain 5 acres or less. It is never used in live streams. Check dams can be useful in the following instances:

1. Temporary ditches or swales
2. Temporary or permanent ditches and swales which need protection during the establishment of grass linings.
3. This practice is not a substitute for major perimeter trapping measures such as a sediment trap or a sediment basin.

### ***Construction Specifications***

No formal design is required for a check dam, however, the following conditions should be adhered to:

1. The drainage area of the ditch or swale being protected shall not exceed 2 acres when 2 to 4 inch aggregate is used alone; and shall not exceed 5 acres when a combination of 4 to 8 inch aggregate (added for stability) and the smaller aggregate is used. Refer to Figure 3.05.1 for orientation of stone and a cross-sectional view of the measure. An effort should be made to extend the stone to the top of channel banks.
2. The maximum height of the dam should be 3 feet.
3. The center of the check dam must be at least 6 inches lower than the outer edges. This is the single most important aspect in the proper installation of the rock check dam. High flows must go over the center of the dam, not around the edges where severe erosion can occur.
4. The maximum spacing between the dams should be such that the toe of the upstream dam is at the same elevation as the top of the downstream dam. The maximum distance between rock check dams is 300 feet.
5. When using a small trap in front of the check dam, ensure the minimum transition from the ditch into the trap is at least 5:1.

### ***Commercial Products***

There are several commercially available products on the market now that are viable alternatives to the rock check dam. See commercial silt dike section

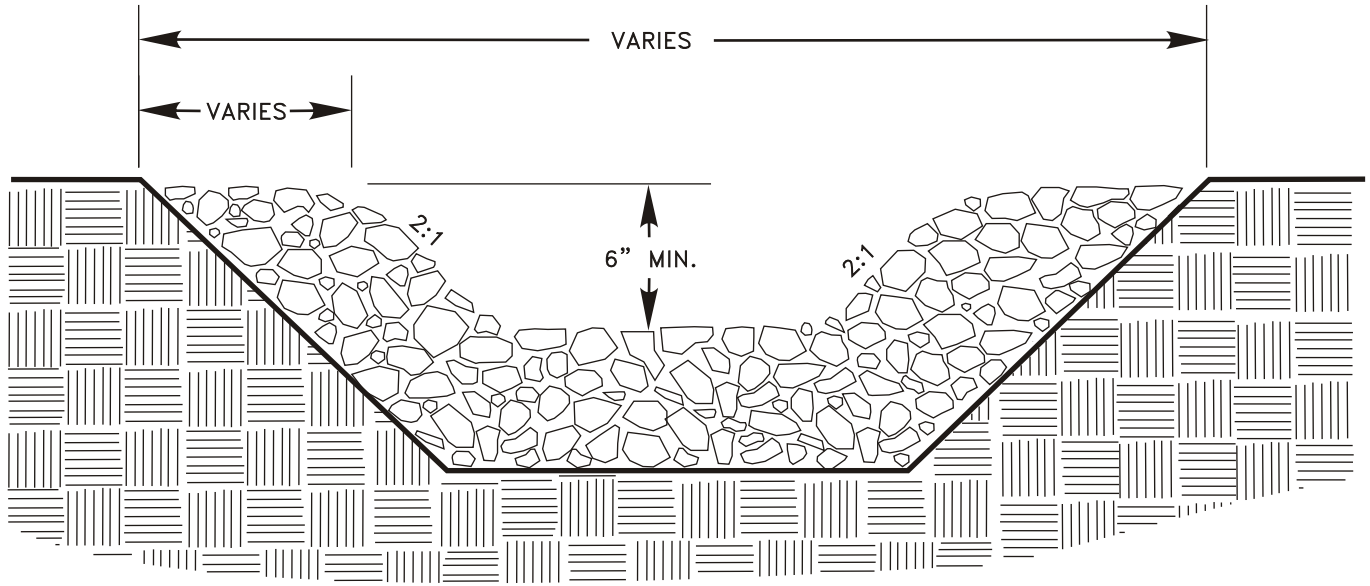
### ***Maintenance***

1. Inspect each check dam at a minimum once every seven calendar days and within 24 hours after any storm event greater than 0.5 inches of rain per 24 hour period. Check to see if water has flowed around the edges of the structure.
2. Replace stone and repair dams as necessary to maintain the correct height and configuration.

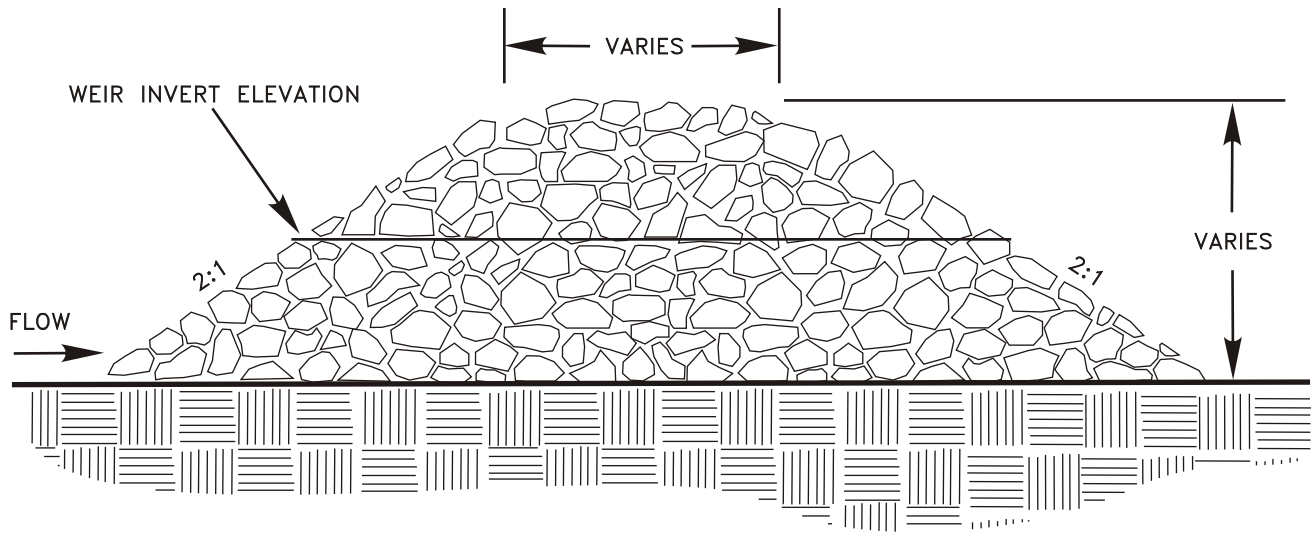
3. Sediment should be removed from behind the check dams when it has accumulated to one half of the original height of the dam. Dispose of the sediment in an appropriate place.

FIGURE 3.05.1

# ROCK CHECK DAM



*ELEVATION*

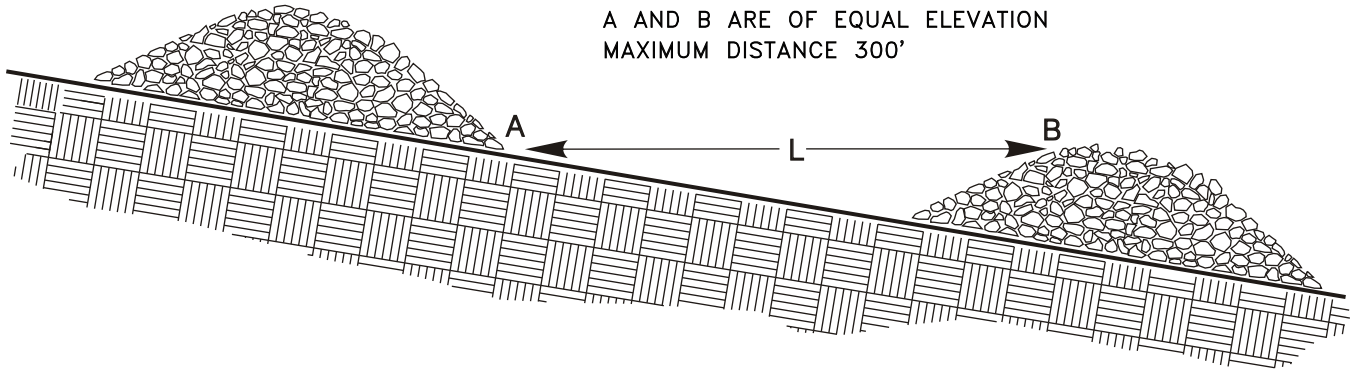


*CROSS SECTION*

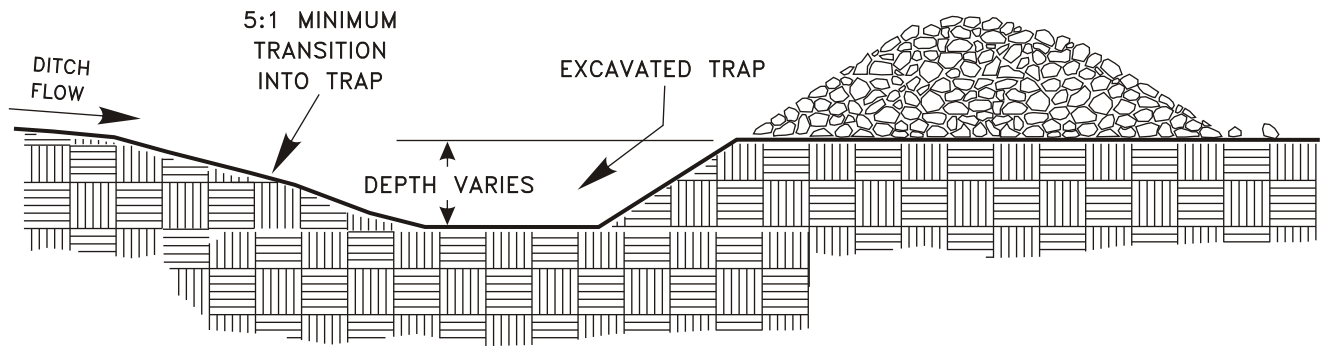
FIGURE 3.05.2

# *ROCK CHECK DAM*

L = THE DISTANCE SUCH THAT POINTS  
A AND B ARE OF EQUAL ELEVATION  
MAXIMUM DISTANCE 300'



## *CHECK DAM SPACING*



## *CHECK DAM WITH SUMP*

## 3.06 - WATTLES

---

### ***Introduction***

Wattles are erosion and sediment control barriers consisting of straw or other organic materials wrapped in biodegradable tubular plastic or similar encasing material. Sometimes called Fiber Rolls. Wattles may reduce the velocity and theoretically spread the flow of rill and sheet runoff, and can capture and retain sediment. Wattles are typically 8 to 20 inches in diameter and 10 to 30 feet in length. The wattles are placed in shallow trenches and staked along the contour of disturbed or newly constructed slopes or in low flow ditches where they can function as check dams.

Wattles reduce slope length, and are intended to capture and keep sediment on the slopes. Wattles are useful to temporarily stabilize slopes by reducing soil creep, and sheet and rill erosion until permanent vegetation can be established. Wattles can catch soil that is moved down the slope by the freeze/thaw processes. Organic matter and seeds are trapped behind the rolls, which provide a stable medium for germination. Rolls trap topsoil and retain moisture from rainfall, which aids in growth of seedlings planted upslope of the rolls.

### ***Conditions Where Practice Applies***

1. Install on disturbed areas that require immediate erosion protection.
2. Use on slopes requiring stabilization until permanent vegetation can be established.
3. Can be used along the perimeter of a project, as a check dam in unlined ditches and around temporary stockpiles
4. Wattles can be staked to the ground using willow cuttings for added revegetation
5. Erosion can occur beneath and between wattles if not properly entrenched, allowing water to pass below and between wattles. It is therefore very important to install wattles correctly.
6. They can replace sediment fence on steep slopes.
7. Rolls are a short-term solution to help establish native vegetation
8. Rolls store moisture for vegetation planted immediately upslope.
9. Plastic netting will eventually photo-degrade, eliminating the need for retrieval of materials after the fiber or straw has broken down.

### ***Construction Specifications***

1. It is critical that wattles are installed perpendicular to the flow direction and parallel to the slope contour.
2. Narrow trenches should be dug across the slope, on contour, to a depth of 3 to 5 inches on clay soils and soils with gradual slopes. On loose soils, steep slopes, and during high rainfall events, the trenches should be dug to a depth of 5 to 7 inches, or  $\frac{1}{2}$  to  $\frac{2}{3}$  of the thickness of the wattle.

3. Start construction of trenches and installing wattles from the base of the slope and work uphill. Excavated material should be spread evenly along the uphill slope and compacted using hand tamping or other method. Construct trenches at contour intervals of 3 to 30 feet apart depending on the steepness of the slope, soil type, and rainfall. The steeper the slope the closer together the trenches should be constructed.
4. Install the wattles snugly into the trenches and abut tightly end to end. Do not overlap the ends.
5. Install stakes at each end of the wattle, and at 4-foot centers along the entire length of the wattle.
6. If required, install pilot holes for the stakes using a straight bar to drive holes through the wattle and into the soil.
7. At a minimum, wooden stakes should be approximately  $\frac{3}{4}$  x  $\frac{3}{4}$  x 24 inches. Willow cuttings or 3/8-inch rebar can also be used for stakes.
8. Stakes should be driven through the middle of the wattle, leaving 2 to 3 inches of the stake protruding above the wattle.

### ***Maintenance***

Inspect wattles at least once a week and after each rain event greater than 0.5 inch.

Repair or replace split, torn, raveling, or slumping wattles.

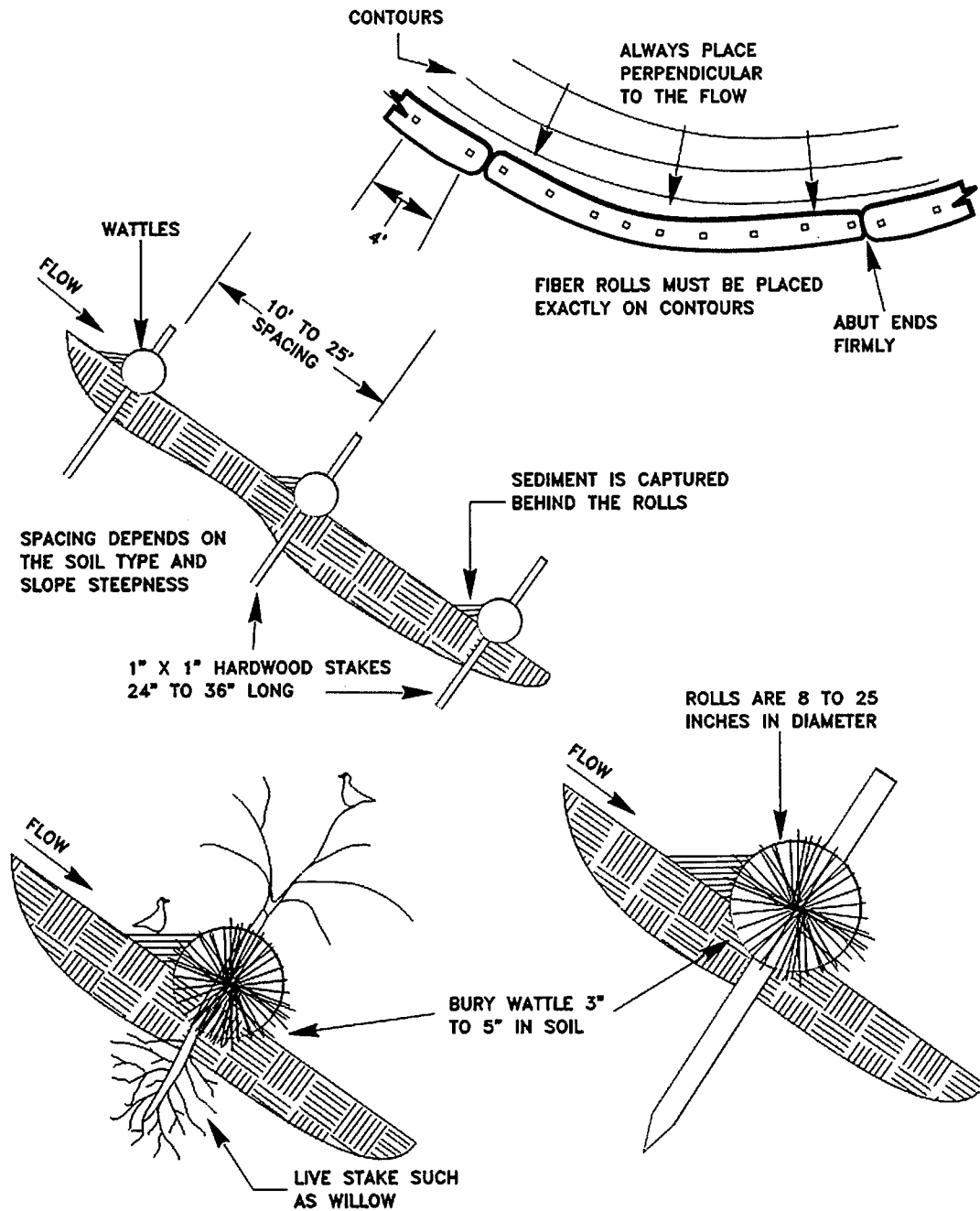
Remove sediment accumulations when exceeding  $\frac{1}{2}$  the height between the top of the wattle and the ground surface.

Repair any rills or gullies promptly.

Reseed or replant vegetation if necessary until the slope is stabilized

FIGURE 3.06.1

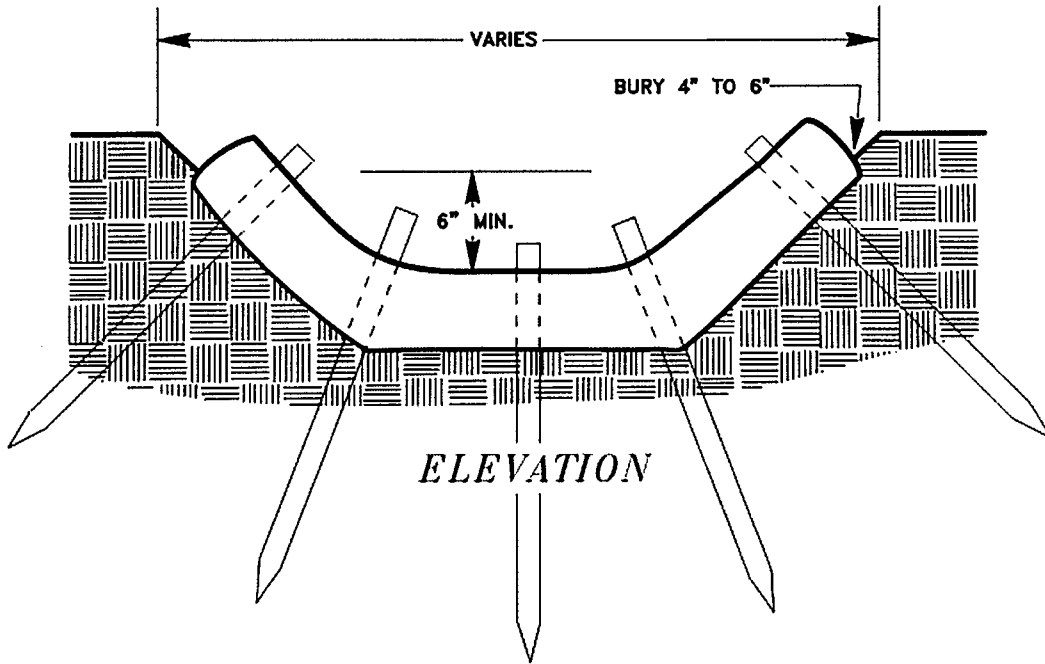
# WATTLES



ADAPTED FROM JOHN MCCULLAGH, SALIX AND OREGON DEQ

FIGURE 3.06.2

# STRAW WATTLE DITCH CHECK





## 3.07 - COMMERCIAL SILT DIKES

---

### ***Introduction***

Rock check dams are the most commonly used practice to protect ditchlines from erosion and to trap small amounts of sediment. There are now several commercially available replacements for rock check dams. These new check dams are made from a variety of lightweight materials. One of these is made from foam rubber surrounded by a geotextile filter fabric. Others are made from plastic or a combination of synthetics and natural materials. They can be used as check dams, perimeter protection, drop inlet protection, or as a temporary interceptor dike.

Commercial silt dikes work on the same principle as rock check dams; they intercept and pond sediment-laden runoff. Ponding the water reduces the velocity of any incoming flow and allows some of the suspended sediment to settle. Water exits some commercial silt dikes by flowing over the top and others by flowing through with higher flows going over the top. The apron on the downstream side of the dike helps prevent scour caused by this flowing water.

### ***Conditions Where Practice Applies***

1. In place of rock check dams in ditches, especially in locations where hauling the rock would be difficult or in ditches with shallow soils underlain by rock.
2. May be used on soil with staples or on pavement with adhesive.
3. Commercial silt dikes can be used creatively to build temporary sediment traps, diversion ditches, concrete washout facilities, curbing, water bars, level spreaders, and berms.

### ***Construction***

#### ***Specifications***

1. Commercial silt dikes are made of urethane foam sewn into a woven geosynthetic fabric, permeable plastic or wattles.
2. Commercial silt dikes come in various shapes, sizes and materials and must be used as detailed in this practice and as the manufacturer states. The connection between individual pieces must be continuous.
3. Install commercial silt dikes perpendicular to the flow of the water except when used as diversions.
4. The commercial silt dikes should extend far enough so that the bottoms of the end dikes are higher than the top of the lowest center dike. This prevents water from flowing around the commercial silt dikes.
5. Attach the commercial silt dikes and their flaps to the ground with wire staples. Wire staples must be No. 11 gauge wire or stronger and shall be 6 to 12 inches in length. Follow the manufacturer's recommendation for installation.
6. When multiple units are installed, the sleeve of fabric at the end of the unit shall overlap the abutting unit and be stapled.

7. Commercial silt dikes must be located and installed as soon as construction will allow.
8. When used as check dams, the leading edge must be secured with rocks, sandbags, or a small key slot and staples.
9. Space dikes apart as shown for rock check dams.
10. Commercial silt dikes can be removed when the grass channel lining has matured sufficiently to protect the ditch or the ditch is stabilized with some sort of permanent lining such as riprap. The soil beneath the commercial silt dikes check dams shall be seeded and mulched immediately after dam removal.

***Maintenance***

Inspect at a minimum once every seven calendar days and within 24 hours after any storm event greater than 0.5 inches of rain per 24 hour period. Sediment shall be removed when it reaches one half the height of the silt dike.

Anticipate submergence and deposition above the dike and erosion from high flows around the edges of the dike/dam. Immediately repair any damage or any undercutting of the dike/dam.

## 3.08 - SURFACE ROUGHENING

---

### ***Introduction***

Surface roughening means providing a rough soil surface with horizontal depressions created by operating a tillage or other suitable implement on the contour, or by leaving slopes in a roughened condition by not fine-grading them. This will aid in establishment of vegetative cover with seed, reduce runoff velocity, and increase infiltration, and reduce erosion and provide for sediment trapping. Surface roughening is also a way to prepare the seedbed.

### ***Conditions Where Practice Applies***

1. All slopes steeper than 3:1 require surface roughening, either stair-step grading, grooving, furrowing, or tracking if they are to be stabilized with vegetation.
2. Areas with grades less steep than 3:1 should have the soil surface lightly roughened and loose to a depth of 2 to 4 inches prior to seeding.
3. Slopes with a stable rock face do not require roughening or stabilization.

### ***Planning Considerations***

It is difficult to establish vegetation on graded areas with smooth, hard surfaces due to reduced water infiltration and the potential for erosion. Rough slope surfaces with uneven soil and rocks left in place may appear unattractive or unfinished at first, but encourage water infiltration, speed the establishment of vegetation, and decrease runoff velocity.

Rough loose soil surfaces give lime, fertilizer and seed some natural coverage. Niches in the surface provide microclimates that generally provide a cooler and more favorable moisture level than hard flat surfaces; this aids seed germination.

There are different methods for achieving a roughened soil surface on a slope, and the selection of an appropriate method depends upon the type of slope. Roughening methods include stair-step grading, grooving, and tracking. Factors to be considered in choosing a method are slope steepness, mowing requirements, and whether the slope is formed by cutting or filling.

### ***Cut Slope Applications For Areas Which Will Not Be Mowed***

Cut slopes with a gradient steeper than 3:1 should be stair-step graded or grooved.

1. Stair-step grading may be carried out on any material soft enough to be ripped with a bulldozer. Slopes consisting of soft rock with some subsoil are particularly suited to stair-step grading.

The ratio of the vertical cut distance to the horizontal distance shall be less than 1:1 and the horizontal portion of the "step" shall slope toward the vertical wall.

Individual vertical cuts shall not be more than 30 inches on soft soil materials and not more than 40 inches in rocky materials.

2. Grooving consists of using machinery to create a series of ridges and depressions that run perpendicular to the slope (on the contour). Grooves may be made with any appropriate implement which can be safely operated on the slope and which will not cause undue compaction. Suggested implements include disks, tillers, spring harrows, and the teeth on a front-end loader bucket. These grooves should not be less than 3 inches deep nor further than 15 inches apart.

***Fill Slope Applications  
For Areas Which Will  
Not Be Mowed***

Fill slopes with a gradient steeper than 3:1 shall be grooved or allowed to remain rough as they are constructed. The methods below may be used:

1. Groove according to #2 above.
2. As lifts of the fill are constructed, soil and rock materials may be allowed to fall naturally onto the slope surface.

At no time shall slopes be bladed or scraped to produce a smooth, shiny, hard surface.

***Cuts, Fills, and Graded  
Areas Which Will Be  
Mowed***

Mowed slopes should not be steeper than 3:1. Excessive roughness is undesirable where mowing is planned. These areas may be roughened with shallow grooves such as remain after tilling, disking, harrowing, raking, or use of a cultipacker-seeder. The final pass of any such tillage implement shall be on the contour (perpendicular to the slope).

Grooves formed by such implements shall be not less than 1-inch deep and not further than 12-inches apart. Fill slopes that are left rough as constructed may be smoothed with a dragline or pick chain to facilitate mowing.

***Roughening With  
Tracked  
Machinery***

Roughening with tracked machinery on clayey soils is not recommended unless no alternatives are available. Undue compaction of surface soil results from this practice. Sandy and rocky soils do not compact severely, and may be tracked. In no case is tracking as effective as the other roughening methods described.

When tracking is the chosen surface roughening technique, it shall be done by operating tracked machinery up and down the slope to leave horizontal depressions in the soil. As few passes of the machinery should be made as possible to minimize compaction.

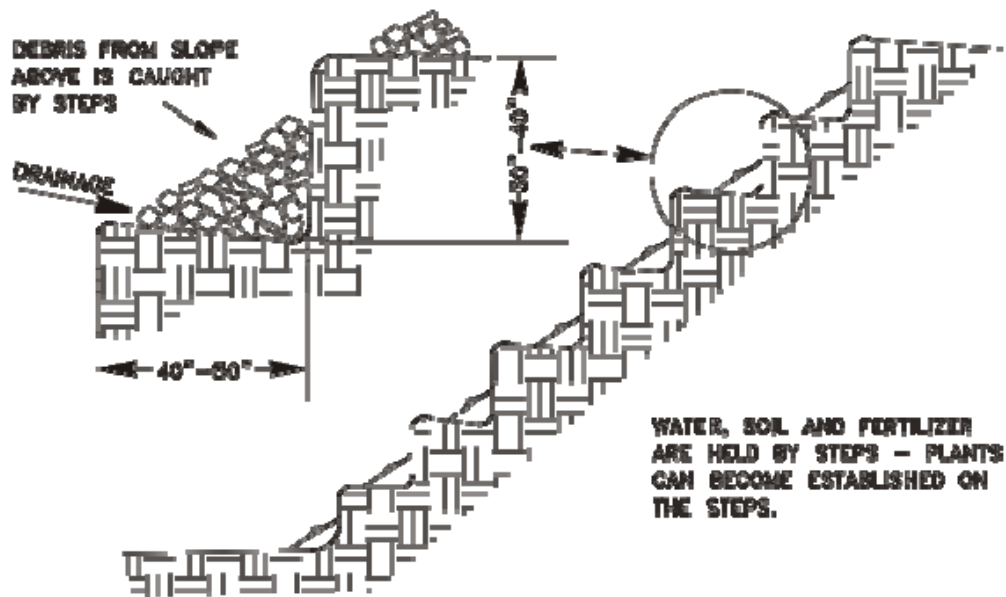
***Seeding***

Roughened areas shall be seeded and mulched as soon as possible to obtain optimum seed germination and seedling growth but at a minimum within seven days of reaching final grade or within seven days if no additional activity is anticipated for 21 days or more.

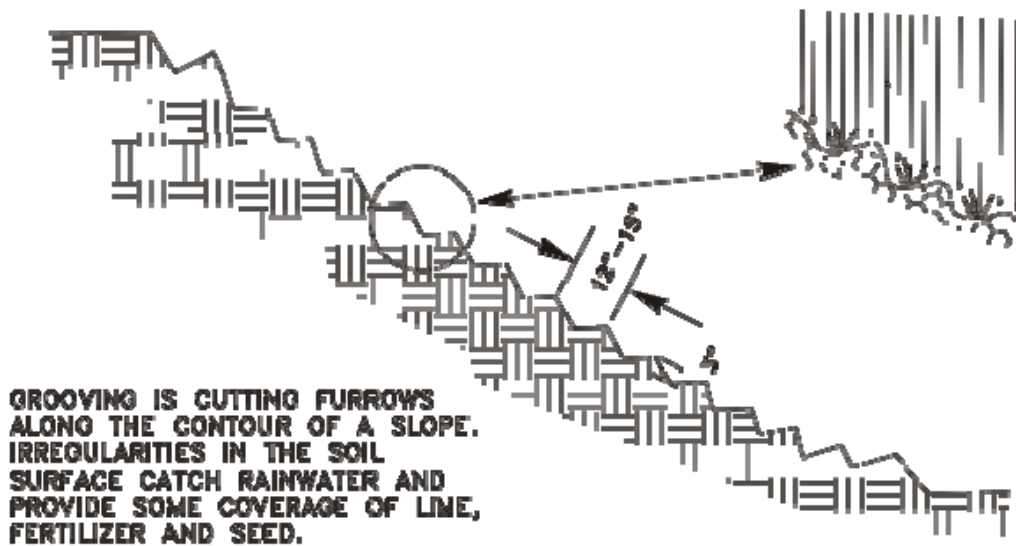
FIGURE 3.08.1

## *SURFACE ROUGHENING*

### *STAIR STEPPING CUT SLOPES*



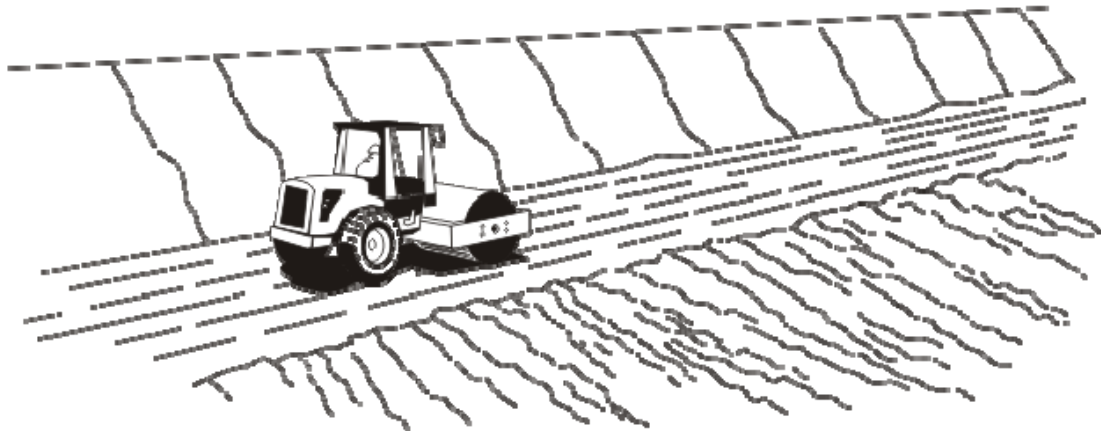
### *GROOVING SLOPES*



SOURCE: VA. DSWC

FIGURE 3.08.2

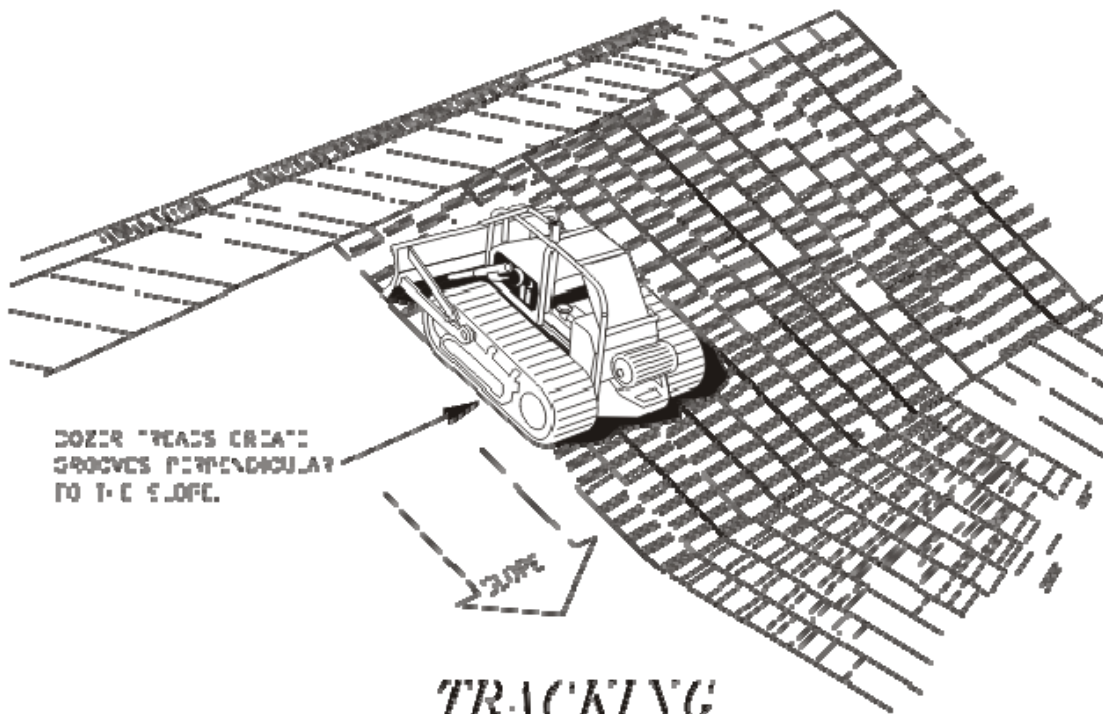
## *SURFACE ROUGHENING*



EACH 1 FT OF THE "L" IS COMPACTED, BUT THE OUTER FACE OF THE SLOPE IS ALLOWED TO REMAIN LOOSE TO PERMIT TREES, LOGS, ETC. TO REACH THE NATURAL ANGLE OF REPOSE.

## *FILL SLOPE TREATMENT*

FROM: VA. CSFC



DOZER TRACKS CREATE GROOVES PERPENDICULAR TO THE SLOPE.

## *TRACKING*

FROM: MC HAN SOIL PROSPECTION AND SEDIMENTATION GUIDE

## 3.09 - TOPSOILING

---

### ***Introduction***

Topsoiling is the spreading of topsoil of a suitable quality over an area to be stabilized by establishing vegetation. Topsoil is the surface layer of the soil profile, generally characterized as darker than the subsoil due to the enrichment with organic matter. It is the major zone of root development and biological activity. Microorganisms that enhance plant growth thrive in this layer. Topsoil can usually be differentiated from subsoil by texture as well as color. Clay content usually increases in the subsoil. Where subsoils are high in clay, the topsoil layer may be significantly coarser in texture. The depth of natural topsoil may be quite variable. On severely eroded sites it may be gone entirely.

Advantages of topsoil include its higher organic matter content, friable consistence (soil aggregates can be easily crushed with only moderate pressure), its available water holding capacity, and its nutrient content. Most often it is superior to subsoil in these characteristics. The texture and friability of topsoil are usually much more conducive to seed germination, emergence, and root growth.

In addition to being a better growth medium, topsoil is often less erodible than subsoil, and the coarser texture of topsoil increases infiltration capacity and reduces runoff.

Vegetative growth is more rapid on sites with at least 4 inches of topsoil, and the health and quality of the vegetation is better than on sites with little or no topsoil.

### ***Conditions Where Practice Applies***

Where the preservation or importation of topsoil is determined to be the most effective method of providing a suitable growth medium.

Where the subsoil or existing soil present any or all of the following problems:

1. The texture, bulk density, pH, or nutrient balance of the available soil cannot be modified by a reasonable means to provide an adequate growth medium for the desired vegetation.
2. The soil is too shallow to provide adequate rooting depth or will not supply necessary moisture and nutrients for growth of desired vegetation.
3. The soil contains substances toxic or potentially toxic to the desired vegetation.
4. Where high-quality turf or ornamental plants are desired.

### ***Design Considerations***

Determine if sufficient quantities of suitable topsoil is available at the site or nearby. Topsoil shall be spread at a lightly compacted depth of 2

to 4 inches. Depths of 4 inches or greater are recommended where fine-textured (clayey) subsoil or other root limiting factors are present.

If topsoil is to be stockpiled at the site, select a location so that it will not erode, block drainage, or interfere with work on the site.

During construction of the project, soil stockpiles shall be stabilized by temporary seeding and mulching and protected with sediment trapping measures such as silt fence. Perimeter controls shall be placed around the stockpile immediately; seeding and mulching of stockpiles shall be completed within seven days of formation of the stockpile if it is to remain in place for longer than 21 days.

If the topsoil is not properly bonded to the existing soil, water will not infiltrate evenly, and it will be difficult to establish vegetation.

Care must be taken not to apply topsoil to an existing soil surface if the two have contrasting textures. Clayey topsoil over sandy subsoil is a particularly poor combination, as water creeps along the junction between the two soil layers and may cause the topsoil to slough.

Do not apply topsoil to slopes greater than 2:1 to avoid slippage. Topsoiling of steep slopes should be discouraged unless good bonding of the soils can be achieved.

### ***Construction Specifications***

The plans and specifications for installing topsoil shall be in keeping with this standard and shall describe the requirements for applying the practice to achieve its intended purpose. At a minimum include the following items:

1. Topsoil source.
2. Stockpile location and method of stabilization prior to its use.
3. Topsoil/subsoil bonding procedures.
4. Site preparation plans and method of application, distribution and compaction.

**Site preparation-** Before spreading topsoil, assure that all necessary erosion and sediment control practices such as diversions, berms, dikes, waterways, and sediment basins are in place and functioning properly. These practices must be maintained until the site is permanently stabilized.

**Grading-** Maintain grades on the areas to be topsoiled according to the approved plan and do not alter them by adding topsoil.

**Liming of subsoil-** Where the pH of the existing subsoil is 6.0 or less, or the soil is composed of heavy clays, incorporate agricultural limestone in amounts recommended by soil tests or specified for the seeding mixture to be used. Incorporate lime to a depth of at least 2 inches by disking.



**Roughening-** Immediately prior to spreading the topsoil, loosen the subgrade by disking or scarifying to a depth of at least 4 inches, to ensure bonding of the topsoil and subsoil. If no amendments have been incorporated, loosen the soil to a depth of at least 6 inches before spreading the topsoil.

**Spreading topsoil-** Uniformly distribute topsoil to a minimum compacted depth of 2 inches on 3:1 slopes and 4 inches on flatter slopes.

Topsoil shall not be spread while it is frozen or saturated or when the subsoil is frozen or saturated.

Irregularities in the surface that result from topsoiling or other operations shall be corrected to prevent the formation of depressions or ponding of water.

Compact the topsoil enough to ensure good contact with the underlying soil, but avoid excessive compaction, as it increases runoff and inhibits seed germination and seedling growth. Light packing with a roller is recommended where high-maintenance turf is to be established.

In areas that are not going to be mowed, the surface can be left rough.

### ***Maintenance***

After topsoil application, follow procedures for seedbed preparation. Take care to avoid excessive mixing of topsoil into the subsoil. Permanently stabilize the site following appropriate practice standards as quickly as practicable. Periodically inspect the site until permanent stabilization is achieved. Make necessary repairs to eroded areas or areas of light vegetative cover.

## 3.10 - TEMPORARY SEEDING

---

### ***Introduction***

Temporary erosion control measures consist of seeding and mulching, or matting used to produce a quick ground cover to reduce erosion on exposed soils that may be redisturbed or permanently stabilized at a later date.

### ***Conditions Where Practice Applies***

Use this method where exposed soil surfaces are not to be fine-graded for periods longer than 21 days. Such areas include denuded areas, soil stockpiles, dikes, dams, sides of sediment basins, temporary road banks, etc. A permanent vegetative cover shall be applied to areas that will be left unworked for a period of more than six months.

### ***Planning Considerations***

Sheet erosion, caused by the impact of rain on bare soil, is the source of most fine particles in sediment. To reduce this sediment load in runoff, the soil surface itself should be protected. The most efficient and economical means of controlling sheet and rill erosion is to establish vegetative cover. Annual plants that sprout rapidly and survive for only one growing season are suitable for establishing temporary vegetative cover. Temporary seeding is encouraged whenever possible to aid in controlling erosion on construction sites.

Temporary seeding also reduces costly maintenance operations on sediment control systems. For example, sediment basin/trap clean-outs can be reduced if its drainage area is vegetated when grading is not taking place. Perimeter dikes are more effective if not choked with sediment. Silt fence does not need to be cleaned as often.

Temporary seeding is essential to preserve the integrity of earthen structures used to control erosion and sediment, such as dikes, diversions, and the banks and dams of sediment basins/traps. If the design life of the basin or trap is more than one year, permanent seeding should be used.

Proper seedbed preparation and the use of quality seed are important in this practice just as in permanent seeding. Failure to carefully follow sound agronomic recommendations will often result in an inadequate stand of vegetation that provides little or no erosion control.

### ***Construction Specifications***

Prior to seeding, install necessary erosion control practices such as dikes, waterways, and basins.

### ***Plant Selection***

Select plants appropriate to the season and site conditions.

### ***Seedbed Preparation***

To control erosion on bare soil surfaces, plants must be able to germinate and grow. Seedbed preparation is essential. If the area has been recently

loosened or disturbed, no further roughening is required. When the area is compacted, crusted, or hardened, the soil surface must be loosened by disking, raking, harrowing, or other acceptable means (see surface roughening section).

***Seeding***

Seed shall be evenly applied with a broadcast seeder, drill, cultipacker seeder or hydroseeder. Small grains shall be planted no more than 1.5 inches deep. Small seeds, such as annual rye, shall be planted no more than quarter inch deep. Other grasses and legumes shall be planted no more than half inch deep.

***Mulching***

Temporary seeding conducted in fall for winter cover and during hot and dry summer months shall be mulched with straw or hay according to the standard for mulching. Hydromulches (fiber mulch) may not provide adequate temperature and moisture control.

***Maintenance***

Areas that fail to establish a vegetative cover adequate to prevent rill erosion should be re-seeded as soon as such areas are identified.

**Table 3.10.1 Temporary seed chart**

PLANT NAMES		PLANTING DATES	APPLICATION RATE LBS/ACRE
COMMON	SCIENTIFIC		
Annual Ryegrass	<i>Lolium multiflorum</i>	2/16 – 5/15 8/1 – 11/1	40
Field Bromegrass	<i>Bromus ciliatus</i>	3/1 – 6/15 8/1 – 9/15	40
Spring Oats	<i>Avena sativa</i>	3/1 – 6/15	100
Winter Rye	<i>Secale cereale</i>	8/15 – 2/28	170
Winter Wheat	<i>Triticum aestivum</i>	8/15 – 2/28	180
Japanese Millet	<i>Echinochloa crusgalli</i>	5/15 – 8/15	30
Redtop	<i>Agrostis alba</i>	3/1 – 6/15	10
Annual Ryegrass and Spring Oats	<i>Lolium multiflorum</i> <i>Avena sativa</i>	3/1 – 6/15	30 70
German/Foxtail Millet	<i>Setaria italica</i>	5/1 – 8/1	40
Hairy Vetch	<i>Vicia villosa</i>	8/15 – 4/1	60

\*Inoculation is required. If a hydroseeder is utilized, the application rate is 5 times the recommended rate.

# 3.11 - PERMANENT SEEDING

---

<b>Introduction</b>	Permanent seeding is the establishment of perennial vegetative cover on disturbed areas by planting seed.
<b>Purpose</b>	<ol style="list-style-type: none"><li>1. To reduce erosion and decrease sediment yield from disturbed areas.</li><li>2. To permanently stabilize disturbed areas in a manner that is economical, adaptable to site conditions and allows selection of the most appropriate plant materials.</li></ol>
<b>Conditions Where Practice Applies</b>	<ol style="list-style-type: none"><li>1. Disturbed areas where permanent, long-lived vegetative cover is needed to stabilize the soil.</li><li>2. Rough-graded areas that will not be brought to final grade for six months or more.</li></ol>
<b>Planning Considerations</b>	<p>Vegetation controls erosion by reducing the velocity and the volume (by increasing infiltration) of overland flows, protecting the bare soil surface from raindrop impact and binding the soil particles together by the roots and rhizomes.</p> <p>Advantages of seeding over other means of establishing plants include the small initial establishment cost, the wide variety of grasses and legumes available, low labor requirement and ease of establishment in difficult areas.</p> <p>Disadvantages include the potential for erosion during the establishment stage, a need to reseed areas that fail to establish, limited periods during the year suitable for seeding, the potential need for weed control during the establishment phase, and a need for water and appropriate micro-climatic conditions during germination.</p> <p>There are so many variables in plant growth that an end product cannot be guaranteed. Much can be done in the planning stages to increase the chances for successful seeding. Selection of the right plants for the site, good seedbed preparation, proper timing and conscientious maintenance are important. By meeting the requirement to seed and mulch your site within seven days, the seedbed preparation and timing components are easily met.</p>
<b>Selecting Plants</b>	The factors affecting plant growth are climate, soils and topography. In West Virginia, there are three major physiographic regions that reflect changes in soil and topography. In selecting appropriate plant materials, one should take into account the characteristics of the physiographic region in which the project is located.
<b>Physiographic Regions</b>	<b>Western Plateau-</b> Characterized by steep slopes and narrow valleys drained by dendritic low gradient streams. Soils are highly variable and on the acidic side. Erosion can be catastrophic and almost impossible to control, especially in the western sections of the state. Clays and silty-clays predominate with rich well-drained soils in the major river valleys. Rainfall averages 40 inches a year and is spread evenly throughout the year. Rain events average every four days. Soil moisture is optimal in the spring and fall. Droughts of short duration can occur every summer. Both cool and warm season grasses will grow.

**Ridge and Valley Region-** This region is divided into plateaus, mountains, narrow valleys and wide fertile valleys near the major stems of the Potomac River. Streams have medium gradient. Soils tend to be shallow and acid, and may erode rapidly on steep slopes. The significant shaley slopes are often unstable and droughty. This area is significantly drier than the rest of the state; however, storm events are significantly greater. The rugged topography makes plant establishment difficult. Cool season grasses are normally specified in this region.

**Mountains-**This region consists of high mountains (up to 4,860 feet) and plateaus, deep, steep valleys, short summers and cold snowy winters, and fast flowing, steep gradient streams. Rainfall averages 50 to 60 inches with up to 240 inches of snow each winter in the highest elevations. Soil depths range from bedrock along areas of the Allegheny Front, to thin to moderate. The range of soil fertility is large and many are acidic. Erodibility ranges from low in the shaley soils common to the Ridge and Valley, to very high in the soils formed from the Mauch Chunk sandstones. Erosion can be a problem because of the extreme steepness of the slopes. Because of the shortness of the growing season, the timeliness of seeding is of utmost importance. However, summer drought is unusual.

## ***Soils***

Soils in West Virginia usually require some nitrogen fertilization along with phosphorus and potassium to establish plants. Except for shallow limestone soils in Greenbrier, Pocahontas, Jefferson and Berkeley counties, and some small pockets elsewhere, lime is universally needed.

Microclimates, or localized climate conditions, affect plant growth. A south-facing slope is drier and hotter than a north-facing slope, and may require drought-tolerant plants. Shaded areas require shade-tolerant plants; the windward side of a ridge will be drier than the leeward, etc. Shaley soils are droughty.

The addition of lime is equally as important as applying fertilizer. Lime is best known as a pH or acidity modifier, but it also supplies calcium and magnesium, which are plant nutrients. More importantly, the correct pH frees up nutrients to the plant. Soils with a pH that is too low will not allow a plant to utilize nitrogen and phosphorus properly. Raising the pH can also prevent aluminum toxicity by making aluminum less soluble in the soil. Many soils in West Virginia are high in aluminum, which can stunt the growth of plant roots. Also remember that rainfall is acidic, compounding the low pH problem in the soil.

Once the soil temperature is correct, the two key limiting factors of seed germination are pH and moisture. If you control these two factors, your chances of success are greatly enhanced.

## ***Seed Mixtures***

As previously noted, the establishment of high quality turf frequently involves planting one single species. However, in seedings for erosion control purposes, the inclusion of more than one species should always be considered. Mixtures need not be excessive in poundage or seed count. The addition of a quick-growing annual

provides early protection and facilitates establishment of one or two perennials in a mix. More complex mixtures might include a quick-growing annual, one or two legumes and more than one perennial grass. The addition of a nurse crop (quick-growing annuals added to permanent mixtures) is a sound practice for soil stabilization, particularly on difficult sites - those with steep slopes, poor, rocky, erosive soils, those seeded outside of the optimum seeding periods or in any situation where the permanent cover development is likely to be slow. The nurse crop germinates and grows rapidly, holding the soil until the slower-growing perennial (permanent) seedlings become established.

### ***Maintenance***

Even with careful, well-planned seeding operations, failures occur. When it is clear that plants have not germinated on an area or have died, these areas must be prepared and reseeded immediately to prevent erosion damage. It is extremely important to determine why germination did not take place and make any necessary corrective actions. **Healthy vegetation is the most effective erosion control available.** Some highly acidic soils (especially around various coal seams in the coalfields) will resist the best efforts to revegetate them. In these cases, topsoiling will be the only way to establish vegetation.

**Table 3.11.1 Permanent seeding**

SEED MIX	PLANT NAMES		APPLICATION RATE LBS/ACRE
	COMMON	SCIENTIFIC	
A	Kentucky 31 Fescue	<i>Festuca arundinacea</i>	65
	Red Fescue	<i>Festuca rubra</i>	20
	Birdsfoot Trefoil	<i>Lotus corniculatus</i>	5
B	Switchgrass	<i>Panicum virgatum</i>	15
	Perennial Ryegrass	<i>Lolium perenne</i>	20
	Redtop	<i>Agrostis alba</i>	5
	Birdsfoot Trefoil	<i>Lotus corniculatus</i>	15
C	Red Fescue	<i>Festuca rubra</i>	20
	Kentucky Bluegrass	<i>Poa pratensis</i>	40
	Merion Bluegrass	<i>Poa pratensis</i>	30
D	Kentucky 31 Fescue	<i>Festuca arundinacea</i>	45
	Red Fescue	<i>Festuca rubra</i>	20
	Kentucky Bluegrass	<i>Poa pratensis</i>	25
	White Dutch Clover	<i>Trifolium repens</i>	5
E	Perennial Ryegrass	<i>Lolium perenne</i>	30
	Switchgrass	<i>Panicum virgatum</i>	15
	Crownvetch or	<i>Coronilla varia</i>	20
	Perennial Pea	<i>Lathyrus latifolius</i>	30
F	Orchardgrass	<i>Dactylis glomerata</i>	20
	Ladino Clover	<i>Trifolium repens</i>	5
	Redtop	<i>Agrostis alba</i>	5
G	Birdsfoot Trefoil	<i>Lotus corniculatus</i>	15
	Weeping Lovegrass	<i>Eragrostis curvula</i>	45
	Perennial Ryegrass	<i>Lolium perenne</i>	10
H	Crownvetch	<i>Coronilla varia</i>	25
	Orchardgrass	<i>Dactylis glomerata</i>	40
I	Crownvetch	<i>Coronilla varia</i>	25
	Perennial Ryegrass	<i>Lolium perenne</i>	30
J	Perennial Pea	<i>Lathyrus latifolius</i>	30
	Orchardgrass	<i>Dactylis glomerata</i>	30
K	Deertongue	<i>Panicum clandestinum</i>	30
	Birdsfoot Trefoil	<i>Lotus corniculatus</i>	15
	Weeping Lovegrass	<i>Eragrostis curvula</i>	5
L	Orchardgrass	<i>Dactylis glomerata</i>	30
	Serecia Lespedeza	<i>Lespedeza cunata</i>	40
	Ladino Clover	<i>Trifolium repens</i>	5
M	Perennial Ryegrass Ladino	<i>Lolium perenne</i>	50
	Clover	<i>Trifolium repens</i>	5
	Redtop	<i>Agrostis alba</i>	5
N	Crownvetch	<i>Coronilla varia</i>	15
	Orchardgrass	<i>Dactylis glomerata</i>	30
	Redtop	<i>Agrostis alba</i>	5



O	Perennial Ryegrass	<i>Lolium perenne</i>	40
	Birdsfoot Trefoil	<i>Lotus corniculatus</i>	15
	Redtop	<i>Agrostis alba</i>	5
P	Serecia Lespedeza	<i>Lespedeza cunata</i>	40
	Orchardgrass	<i>Dactylis glomerata</i>	30
	Redtop	<i>Agrostis alba</i>	5
Q	Orchardgrass	<i>Dactylis glomerata</i>	25
	Reed Canarygrass <sup>1</sup>	<i>Phalaris arundinacea</i>	30
	Redtop	<i>Agrostis alba</i>	5
	Ladino Clover	<i>Trifolium repens</i>	5
R	Kentucky Bluegrass	<i>Poa pratensis</i>	30
	Redtop	<i>Agrostis alba</i>	5
	White Clover or	<i>Trifolium repens</i>	5
	Birdsfoot Trefoil	<i>Lotus corniculatus</i>	15
S	Reed Canarygrass <sup>1</sup>	<i>Phalaris arundinacea</i>	40
	Weeping Lovegrass	<i>Eragrostis curvula</i>	5
T	Perennial Ryegrass	<i>Lolium perenne</i>	30
	Reed Canarygrass <sup>1</sup>	<i>Phalaris arundinacea</i>	15
	Birdsfoot Trefoil	<i>Lotus corniculatus</i>	5
U	Timothy	<i>Phluem pratense</i>	10
	Alfalfa	<i>Medicago sativa</i>	18
V	Timothy	<i>Phluem pratense</i>	10
	Birdsfoot Trefoil	<i>Lotus corniculatus</i>	15
W	Redtop	<i>Agrostis alba</i>	5
	Perennial Ryegrass	<i>Lolium perenne</i>	30
	Orchardgrass	<i>Dactylis glomerata</i>	25
X	Reed Canarygrass <sup>1</sup>	<i>Phalaris arundinacea</i>	30
	Birdsfoot Trefoil	<i>Lotus corniculatus</i>	20
	Redtop	<i>Agrostis alba</i>	5
Y	Switchgrass	<i>Panicum virgatum</i>	30
	Birdsfoot Trefoil	<i>Lotus corniculatus</i>	20
Z	Switchgrass	<i>Panicum virgatum</i>	15
	Serecia Lespedeza	<i>Lespedeza cunata</i>	30
A-1	Orchardgrass	<i>Dactylis glomerata</i>	30
	Red Clover	<i>Trifolium pratense</i>	10
A-2	Switchgrass	<i>Panicum virgatum</i>	15
	Big Bluestem	<i>Andropogon gerardi</i>	5
	Indiangrass	<i>Sorghastrum nutans</i>	5
	Little Bluestem	<i>Andropogon scoparius</i>	5
	Sideoats Grama <sup>2</sup>	<i>Bouteloua curtipendula</i>	5
A-3	Switchgrass	<i>Panicum virgatum</i>	20
	Eastern Gamagrass <sup>3</sup>	<i>Tripsacum dactyloides</i>	15

NOTE: When utilizing a properly prepared seedbed, the rates of application can be reduced by 30 percent except for seed mixes A-2 & A-3.

<sup>1</sup> Reed Canarygrass shall not be used east of I-79 and/or south of Charleston.

<sup>2</sup> Use north and east of I-64 and I-79.

<sup>3</sup> Use south and west of I-64 and I-79.

**Table 3.11.2 Nurse crops**

PLANT NAMES		PLANTING DATES	APPLICATION RATE LBS/ACRE
COMMON	SCIENTIFIC		
Annual Ryegrass	<i>Lolium multiflorum</i>	2/16 – 5/15 8/1 – 11/1	25
Field Bromegrass	<i>Bromus ciliatus</i>	3/1 – 6/15 8/1 – 9/15	20
Spring Oats	<i>Avena sativa</i>	3/1 – 6/15	50
Winter Rye	<i>Secale cereale</i>	8/15 – 2/28	85
Winter Wheat	<i>Triticum aestivum</i>	8/15 – 2/28	90
Japanese Millet	<i>Echinochloa crusgalli</i>	5/15 – 8/15	15
Redtop	<i>Agrostis alba</i>	3/1 – 6/15	10
Annual Ryegrass and Spring Oats	<i>Lolium multiflorum</i> <i>Avena sativa</i>	3/1 – 6/15	15 35
German/Foxtail Millet	<i>Setaria italica</i>	5/1 – 8/1	25
Hairy Vetch*	<i>Vicia villosa</i>	8/15 – 4/1	30

\* Inoculation is required. If a hydroseeder is utilized, the application rate is five times the recommended rate.

**Table 3.11.3 Permanent seeding requirements**

SEED MIX	FINE LAWN	COARSE LAWN	LOW MAINT.	NO MAINT.	PASTURE	SENSITIVE NATURAL AREAS	pH RANGE	DRAINAGE	SHADE TOLERANCE	PREFERRED PLANTING DATES			
										3/1 -6/15	6/16 -8/14	8/15 - 9/15	9/16 - 2/28
A			✓ <sub>1</sub>				6.0 – 7.5	MOD. - WELL	FULL SUN	✓	◆	✓	◆
B				✓			5.0 – 7.5	MOD. – WELL	FULL SUN	✓	◆	✓	◆
C	✓ <sub>1</sub>						6.0 – 7.5	MOD. – WELL	FULL SUN	✓		✓	
D		✓ <sub>1</sub>					6.0 – 7.5	MOD. – WELL	FULL SUN	✓		✓	
E				✓ <sub>1</sub>			6.0 – 7.5	MOD. – WELL	FULL SUN	✓	◆	✓	◆
F			✓	✓	✓		5.5 – 7.5	MOD. – WELL	TOLERANT	✓	◆	✓	◆
G				✓	✓		5.0 – 7.5	MOD. – WELL	FULL SUN	✓	◆	✓	◆
H			✓	✓ <sub>1</sub>	✓		5.0 – 7.5	MOD. – WELL	TOLERANT	✓	◆	✓	◆
I			✓	✓ <sub>1</sub>	✓		5.0 – 7.5	MOD. – WELL	FULL SUN	✓	◆	✓	◆
J			✓	✓ <sub>1</sub>	✓		4.0 – 8.0	MOD. – WELL	TOLERANT	✓	◆	✓	◆
K				✓			4.0 – 7.0	MOD. – WELL	FULL SUN	✓	◆	✓	◆
L				✓	✓		4.5 – 7.5	MOD. – WELL	TOLERANT	✓	◆	✓	◆
M			✓	✓	✓		5.0 – 7.5	MOD. – WELL	TOLERANT	✓	◆	✓	◆
N			✓	✓ <sub>1</sub>	✓		5.0 – 7.5	MOD. – WELL	TOLERANT	✓	◆	✓	◆
O			✓	✓	✓		5.0 – 7.5	MOD. – WELL	FULL SUN	✓	◆	✓	◆
P			✓	✓	✓		4.5 – 7.5	MOD. – WELL	TOLERANT	✓	◆	✓	◆
Q			✓	✓	✓		4.5 – 7.5	POOR - WELL	TOLERANT	✓	◆	✓	◆
R			✓	✓	✓		5.5 – 7.5	MOD. – WELL	FULL SUN	✓	◆	✓	◆
S			✓	✓	✓		4.5 – 7.5	POOR – WELL	FULL SUN	✓	◆	✓	◆
T					✓		5.5 – 7.5	POOR – WELL	FULL SUN	✓	◆	✓	◆
U					✓		6.5 – 8.0	MOD. – WELL	FULL SUN	✓	◆	✓	◆
V					✓		5.5 – 7.5	POOR – WELL	FULL SUN	✓	◆	✓	◆
W			✓	✓	✓		5.0 – 7.5	MOD. – WELL	TOLERANT	✓	◆	✓	◆
X					✓		5.5 – 7.5	POOR – WELL	FULL SUN	✓	◆	✓	◆
Y			✓	✓	✓		5.0 – 7.5	MOD. – WELL	FULL SUN	✓	◆	✓	◆
Z			✓	✓	✓		5.0 – 7.5	MOD. – WELL	FULL SUN	✓	◆	✓	◆
A-1					✓		4.5 – 7.5	MOD. – WELL	TOLERANT	✓	◆	✓	◆
A-2				✓	✓	✓	5.0 – 7.5	MOD. – WELL	FULL SUN	✓	◆	✓	◆
A-3				✓		✓	5.0 – 7.5	POOR - WELL	FULL SUN	✓	◆	✓	◆

◆ Nurse crop required – See Table B

1 Urban areas only

## ***Seedbed Requirements***

Vegetation should not be established on slopes that are unsuitable due to inappropriate soil texture, poor internal structure or internal drainage, volume of overland flow, or excessive steepness until measures have been taken to correct these problems.

To maintain a good stand of vegetation, the soil must meet certain minimum requirements as a growth medium.

### **The soil should have these characteristics:**

1. Enough fine-grained material to maintain adequate moisture and nutrient supply.
2. Sufficient pore space to permit root penetration. A fine granular or crumb-like structure is favorable.
3. Sufficient depth of soil to provide an adequate root zone. The depth to rock or impermeable layers such as hardpans should be 12 inches or more, except on slopes steeper than 2:1 where the addition of soil is not feasible.
4. A favorable pH range for plant growth.
5. Freedom from toxic amounts of materials harmful to plant growth.
6. Freedom from excessive quantities of roots, branches, large stones, large clods of earth or trash of any kind.

Appropriate structural erosion control practices, such as berms, waterways, diversions, pipe slope drains, water bars or right of way diversions, needed to control overland flow to protect the seedbed should be installed prior to seeding.

Surfaces will be roughened in accordance with surface roughening section contained within this manual.

## ***Soil Conditioners***

In order to modify the texture, structure, or drainage characteristics of a soil, the following materials may be added to the soil:

1. Peat is a very costly conditioner, but works well. If added, it shall be sphagnum moss peat, hypnum moss peat, reed-sedge peat or peat humus, from freshwater sources.
2. Sand shall be clean and free of toxic materials. If this practice is considered, consult a professional authority to ensure that it is done properly.
3. Vermiculite shall be horticultural grade and free of toxic substances.
4. Manure, including poultry litter, in its composted form, is a viable soil conditioner. The use of manure should be based on site-specific recommendations offered by a professional in this field such as an agriculture extension agent or USDA employee.
5. Thoroughly rotted sawdust shall have six pounds of nitrogen added to each cubic yard and shall be free of stones, sticks, and toxic substances.
6. When composted, treated sewage sludge offers an alternative soil amendment. This practice should be thoroughly evaluated by a professional and used in accordance with any local, state, and federal regulations.

## ***Lime and Fertilizer***

Lime and fertilizer needs should be determined by soil tests. Soil tests may be performed by the WVU Extension Service soil testing laboratory or by a reputable commercial laboratory. Information concerning the WVU soil testing laboratory is available from county extension agents.

Under unusual conditions where it is not possible to obtain a soil test, the following soil amendments will be applied:

### **Lime**

Two tons/acre (90 lbs./1,000 ft.<sup>2</sup>) pulverized agricultural grade limestone.

**Note:** An agricultural grade of limestone should always be used except in inaccessible areas; lime may have to be applied separately in pelletized or liquid form.

### **Fertilizer**

Mixed grasses and legumes: 1,000 lbs./acre nutrients (23 lbs./1,000 ft.<sup>2</sup>) 10-20-10 or equivalent.

Legume stands only: 1,000 lbs./acre (23 lbs./ 1,000 ft.<sup>2</sup>) 5-20-10 is preferred; however, 1,000 lbs./acre of 10-20-10 or equivalent may be used.

Grass stands only: 1,000 lbs./acre (23 lbs./1,000 ft.<sup>2</sup>) 10-20-10 or equivalent nutrients.

Other fertilizer formulations, including slow-release sources of nitrogen (preferred from a water quality standpoint), may be used provided they can supply the same amounts and proportions of plant nutrients.

Lime and fertilizer shall be incorporated into the top 4 to 6 inches of the soil by disking or other means whenever possible. When applying lime and fertilizer with a hydroseeder, apply to a rough, loose surface.

## ***Seeding***

1. Appropriately labeled seed will be used for all permanent seeding whenever possible. Labeled seed is inspected by the West Virginia Department of Agriculture. The seed must be appropriately labeled or tagged as defined in the West Virginia Seed Law, Chapter 19 Article 16.
2. Legume seed should be inoculated appropriate to the species. Seed of the lespedezas, the clovers and crownvetch should be scarified to promote uniform germination.
3. Apply seed uniformly with a broadcast seeder, drill, culti-packer seeder or hydroseeder. See Seedbed Requirement above for seedbed preparation. Seeding depth should be a quarter to half inch.
4. To avoid poor germination rates as a result of seed damage during hydroseeding, it is recommended that if a machinery breakdown of 30

minutes to two hours occurs, 50 percent more seed be added to the tank, based on the proportion of the slurry remaining in the tank. Beyond two hours, a full rate of new seed may be necessary.

5. Surface roughening is particularly important when hydroseeding, as a roughened slope will provide some natural coverage for lime, fertilizer and seed.

Legume inoculants should be applied at five times the recommended rate when the inoculant is included in the hydroseeder slurry.

### ***Mulching***

All permanent seeding must be mulched immediately upon completion of seed application. Refer to the mulching section contained within this manual.

### ***Irrigation***

The newly seeded area should be supplied with adequate moisture. Supply water as needed, especially late in the season, in abnormally hot or dry weather, or on adverse sites. Water application rates should be controlled to prevent excessive runoff. Inadequate amounts of water may be more harmful than no water by causing the seedlings roots to curve towards the surface of the ground looking for moisture.

### ***Reseeding***

Inspect seeded areas for failure (less than 70 percent coverage) and make necessary repairs and reseeding within the same growing season, if possible.

- a. If vegetative cover is inadequate to prevent rill erosion, overseed and fertilize in accordance with soil test results. If rills are large enough it may be necessary to regrade the rills out and reestablish a seedbed.
- b. If a stand has less than 70 percent coverage, reevaluate choice of plant materials and quantities of lime and fertilizer. The soil must be tested to determine if acidity or nutrient imbalances are responsible. Reestablish the stand following seedbed preparation and seeding recommendations.

### ***Fertilization***

Cool season grasses should be fertilized 90 days after planting to ensure proper stand and density. Warm season grasses should be fertilized 30 days after planting.

Apply maintenance levels of fertilizer as determined by soil test. In the absence of a soil test, fertilization should be as follows:

#### **Cool Season Grasses**

Apply 4 lbs. nitrogen, 1 lb. phosphorus, 2 lbs. potassium per 1,000 ft.<sup>2</sup> per year. Seventy-five percent of the total requirements should be applied between September 1 and December 31. The balance should be applied prior to May 1 the following year. More than 1 lb. of soluble nitrogen per 1,000 ft.<sup>2</sup> should not be applied at any one time.

#### **Warm Season Grasses**

Apply 4 to 5 lbs. nitrogen between May 1 and August 15 per 1,000 ft.<sup>2</sup> per year. Phosphorus and Potassium should only be applied according to soil test.

**Note:** The use of slow-release fertilizer formulations for maintenance of turf is encouraged to reduce the number of applications and the impact on

groundwater.

**Note:** The permanent seeding section is not meant to be an all-inclusive list of possible seeding mixtures. There may be other purposes such as wildlife habitat or natural beauty that would require alternative mixtures. The DEP encourages the submission of enhanced vegetation plans for other purposes with your NPDES permit application.

# 3.12 – MULCHING INCLUDING FLEXIBLE GROWTH MEDIUM AND BONDED FIBER MATRIX

---

## ***Introduction***

The application of straw, hay or other suitable materials to the soil surface used to:

1. Prevent erosion by protecting the soil surface from raindrop impact and reducing the velocity of overland flow.
2. Foster the growth of vegetation by increasing available moisture and providing insulation against extreme heat and cold. Mulching increases the window of opportunity for seeding by moderating temperature and moisture extremes. This is important because the general permit does not define specific seeding dates and requires only that areas be seeded within seven days of reaching final grade.

## ***Conditions Where Practice Applies***

1. Areas that have been temporarily or permanently seeded should be mulched immediately following seeding.
2. Areas that cannot be seeded because of the season should be mulched to provide some protection to the soil surface. An organic mulch should be used, and the area then seeded as soon as weather or seasonal conditions permit. Do not use fiber mulch (cellulose-hydroseed) alone for this practice; at normal application rates it will not give the protection that is achieved by using other types of mulch.
3. Mulch may be used together with plantings of trees, shrubs, or other ground covers that do not provide adequate soil stabilization by themselves.

## ***Planning Considerations***

Mulches are applied to the soil surface to conserve desirable soil properties or to promote plant growth. Mulching can be an effective means of controlling runoff and erosion on disturbed land.

Mulches increase the infiltration rate of the soil, reduce soil moisture loss by evaporation, prevent crusting and sealing of the soil surface, modify soil temperatures and provide a suitable microclimate for seed germination.

Organic mulch materials such as straw and hay are the most effective, followed by wood chips, bark and fiber.

At this time chemical soil stabilizers or soil binders should not be used alone for mulch. These materials are useful to bind organic mulches together to prevent displacement.



A variety of manufactured rolled erosion control products have been developed for erosion control in recent years. See standard for erosion control matting for alternatives to mulching. Some of these products can be used as mulches, particularly in critical areas such as waterways, steep slopes and windy ridges. They also may be used to hold other mulches to the soil surface.

The choice of materials for mulching will be based on the type of soil to be protected, site conditions, season and economics. It is especially important to mulch liberally in mid-summer and prior to winter, and on cut slopes and southern slope exposures.

### **Organic mulches**

**Straw-** The mulch most commonly used in conjunction with seeding. The straw should come from wheat or oats (free of troublesome weed seeds) and may be spread by hand or machine. Straw can be windblown and should be anchored down by an acceptable method. Straw's attributes such as its hollow core (provides insulation), rigidity (does not easily compress) and general lack of weeds makes it the best mulch available

**Hay-** May be used in lieu of straw where incompatible vegetation will not present a problem, and may be spread by hand or machine. Hay can be windblown and should be anchored or tacked down.

Additionally, when hay or straw mulch decomposes it adds valuable organic material to the soil.

**Wood cellulose fiber mulch-** Used in hydroseeding operations and applied as part of the slurry. It creates the best seed-soil contact when applied over top of (as a separate operation) newly seeded areas. These mulches do not require tacking, although tacking agents or binders are sometimes used in conjunction with the application of fiber mulch. Fiber mulch does not provide sufficient protection on highly erodible soils or during less favorable growing conditions. **Fiber mulch should not be used alone during the dry summer months or for late fall mulch cover.** Use straw/hay mulch during these periods. Fiber mulch may be used to tack (anchor) straw/hay mulch. Fiber mulch is well suited for steep slopes, critical areas, and areas susceptible to wind.

### **Chemical mulches, soil binders and tackifiers**

A wide range of synthetic spray-on materials is marketed to stabilize and protect the soil surface. These are emulsions or dispersions of petroleum distillates, emulsions of copolymer acrylates, latexes, and polyvinyl acetates, clay colloids, and dry powered vegetable gums derived from guar, psyllium, and sodium alginase, which are mixed with water and sprayed over the mulch and to the soil. They may be used alone in some cases as temporary stabilizers, or in conjunction with fiber mulch, hay or

straw. The DEP does not recommend the use of asphalt emulsion as a binder.

Unlike organic mulches, most chemical mulches do not insulate the soil or retain soil moisture when used alone. They may also be easily damaged by traffic. Application of these mulches is usually more expensive than organic mulching, and the mulches decompose quickly.

The industry is continually improving alternative soil binders/mulches and the permittee is encouraged to investigate these new products for use on the site.

Always follow the manufacturer's recommendations when applying any of the above products.

### ***Construction Specifications***

#### **Organic mulches**

Organic mulches may be used in any area where mulch is required, subject to the restrictions noted in Table 3.12.1.

Select mulch material based on site requirements, availability of materials and availability of labor and equipment. Table 3.12.1 lists the most commonly used organic mulches.

Prior to mulching, complete the required grading and install needed sediment control practices.

Lime and fertilizer should be incorporated and surface roughening accomplished as needed. Seed should be applied prior to mulching except in the following cases:

1. Where seed is to be applied as part of a hydroseeder slurry containing wood cellulose fiber mulch (DEP recommends that the seed be spread prior to the spraying of the fiber mulch if at all possible).
2. Where seed is to be applied following a temporary mulch spread during winter months.

Mulch materials shall be spread uniformly, by hand or machine. When spreading straw mulch by hand, divide the area to be mulched into approximately 1,000 sq. ft. sections and place 70-90 lbs. (1½ to 2 bales) of straw in each section to facilitate uniform distribution.

Straw and hay mulch should be anchored immediately after spreading to prevent displacement. Other organic mulches listed in Table 3.12.1 should not require anchoring. The following methods of anchoring straw and hay may be used:

1. **Mulch anchoring tool (often referred to as a krimper or krimper tool)** - A tractor-drawn implement designed to punch mulch into the soil surface. This method provides good erosion control with straw. It is limited to use on slopes where the equipment can operate safely. Machinery shall be operated on the contour.
2. **Wood cellulose fiber mulch-** Apply fiber mulch by means of a hydroseeder at a rate of 500-750 lbs./acre over top of straw mulch or hay. It has an added benefit of providing additional mulch to the newly seeded area.
3. **Liquid mulch binders-** Application of liquid mulch binders and tackifiers should be heaviest at edges of areas and at crests of ridges and banks, to prevent displacement. The remainder of the area should have binder applied uniformly. Binders may be applied after mulch is spread or may be sprayed into the mulch as it is being blown onto the soil.
4. **Synthetic binders-** Formulated binders or organically formulated products may be used as recommended by the manufacturer to anchor mulch.
5. **Mulch netting-** Lightweight plastic, cotton and coir nets may be stapled over the mulch according to manufacturer's recommendations (See rolled erosion control products section).

### **Chemical mulches**

Chemical mulches\* may be used alone only in the following situations:

1. Where no other mulching material is available.
2. From March 15 to May 1 and August 15 to September 30, provided that they are used on areas with slopes no steeper than 4:1, which have been roughened in accordance with surface roughing standards. If rill erosion occurs, another mulch material shall be applied immediately.

\* **Note:** Some chemical mulches may be used to bind other mulches or with fiber mulch in a hydroseeded slurry. Manufacturer's recommendations for application of chemical mulches shall be followed.

### ***Maintenance***

All mulches and soil coverings should be inspected periodically (particularly after rainstorms and high winds) to check for erosion and displacement. Where erosion is observed in mulched areas, additional mulch should be applied and erosion repaired if necessary. Nets and mats should be inspected after rainstorms for dislocation or failure. If washouts or breakage occur, reinstall netting or matting as necessary after regrading to repair damage to the slope or ditch. Inspections should take place up until grasses are firmly established or the area is redisturbed.

<b>Table 3.12.1 Organic mulch materials and application rates</b>			
Mulches:	Rates:		Notes:
	Per acre	Per 1,000 ft <sup>2</sup> .	
Straw or hay	1½ - 2 tons (minimum 2 tons for winter cover)	70 - 90 lbs.	Free from weeds and coarse matter. Must be anchored. Spread with mulch blower or by hand.
Fiber mulch	Minimum 1,500 lbs.	35 lbs.	Do not use as mulch for winter cover or during hot, dry periods.* Apply as slurry.
Cornstalks	4 - 6 tons	185 - 275 lbs.	Cut or shredded in 4-6" lengths. Air-dried. Do not use in fine turf areas. Apply with mulch blower or by hand.
Wood chips	4 - 6 tons	185 - 275 lbs.	Free of coarse matter. Air-dried. Treat with 12 lbs. nitrogen per ton. Do not use in fine turf areas. Apply with mulch blower, chip handler, or by hand.
Bark chips or Shredded bark	50 - 70 cu. yds.	1-2 cu. yds.	Free of coarse matter. Air-dried. Do not use in fine turf areas. Apply with mulch blower, chip handler, or by hand.
* When fiber mulch is the only available mulch during periods when straw should be used, apply at a minimum rate of 2,000 lbs./ac. or 45 lbs./1,000 sq. ft.			

From VA DSWC

# 3.13 - ROLLED EROSION CONTROL PRODUCTS

---

## ***Introduction***

Rolled Erosion Control Products (RECPs) are temporary or permanent erosion control nets, blankets and three-dimensional matrixes made from a wide variety of natural (such as jute, coir and straw) and manmade materials alone or in combination. There are numerous commercially available products so great care must be used to choose the correct product for the application.

RECPs help prevent erosion in several ways. They can be a direct replacement for straw or hay mulch and provide uniform protection from raindrop erosion, moderating temperature and moisture extremes and preventing detachment of the soil by sheet flow. They can hold seed and mulch in place on slopes and in channels so that vegetation can become established. And they can be used to permanently reinforce turf to protect channels and stream banks in high flows conditions.

## ***Conditions Where Practice Applies***

### **Temporary Rolled Erosion Control Products**

Temporary rolled erosion control products (RECPs) consist of prefabricated blankets or netting that are formed from both natural and synthetic materials. Temporary RECPs are used as a temporary surface stabilizing measure and to aid in the establishment of vegetation. They are typically used on steep slopes and to help establish grass in low velocity vegetated channels.

Temporary RECPs consist of netting or blanket materials that are used to stabilize disturbed surfaces and promote the establishment of vegetation. RECPs may also be used to stabilize the surface of channels where the flows are low to moderate until vegetation can be established.

They are manufactured from a wide variety of different materials including coconut fiber (coir), jute, nylon, polypropylene, PVC, straw, hay, or wood excelsior. These materials may be used individually, or in combination to form nets or blankets.

The products function by protecting the ground surface from the impact of raindrops and stabilize the surface until vegetation can be established. RECPs also promote the growth of vegetation by helping to keep seed in place, and by maintaining a consistent temperature and moisture content in the soil.

RECPs are not intended to provide long-term or permanent stabilization of slopes or channels. Their role is to protect the surface until the vegetation can establish itself and become the permanent stabilizing

feature. In fact, most RECPs are either biodegradable or photodegradable and will decompose over a period of time.

Jute matting must be used in conjunction with mulch. Excelsior, woven straw blankets and coir (coconut fiber) blankets may be installed without mulch. There are many other types of erosion control nets and blankets on the market that may be appropriate in certain circumstances.

In general, most nets (e.g., jute matting) require mulch in order to prevent erosion because they have a fairly open structure. Blankets typically do not require mulch because they usually provide complete protection of the surface.

The temporary rolled erosion control product shall conform to one of the following specifications and corresponding properties found in Table 3.13.1

### **Permanent Rolled Erosion Control Products**

Permanent RECPs or Turf Reinforcement Mats (TRMs) are similar to the Temporary RECPs but they usually are intended for reinforcing grass-lined channels and stream banks and can be useful when underlying soil boundaries may subside or shift slightly after installation. They are composed of ultraviolet (UV) stabilized polymeric fibers, filaments, nettings and/or wire mesh, integrating together to form a three-dimensional matrix. The types of polymer include polypropylene, polyethylene, polyamides, and polyvinyl chloride. Often TRMs are combined with organic material such as coir to aid vegetation establishment and provide the initial temporary erosion control necessary to resist the forces of running water until the vegetation can become established. Typical vegetation includes grasses that can withstand inundation.

TRMs can be installed after applying seed to the prepared soil surface or deployed first, and then seeded following infilling with soil. The former method allows the roots and shoots to grow through and interlock with the geosynthetic matrix.

For applications where natural vegetation alone will not sustain expected flow conditions and/or provide sufficient long-term erosion protection a permanent rolled erosion control product will be required. The permanent RECP must have the necessary performance properties to effectively control erosion and reinforce vegetation under the expected long-term site conditions.

The permanent erosion control product shall conform to one of the specifications and corresponding properties found in Table 3.13.2.

**Rolled erosion control products are designated as follows:**

1. Mulch control netting. (MCN) A planar woven natural fiber or extruded geosynthetic mesh used as a temporary degradable rolled erosion control product to anchor loose fiber mulches.
2. Open weave textile. (OWT) A temporary degradable rolled erosion control product composed of processed natural or polymer yarns woven into a matrix, used to provide erosion control and facilitate vegetation establishment. Can replace straw or hay mulch.
3. Erosion control blanket. (ECP) A temporary degradable rolled erosion control product composed of processed natural or polymer fibers mechanically, structurally or chemically bound together to form a continuous matrix to provide erosion control and facilitate vegetation establishment. Can replace straw or hay mulch.
4. Turf reinforcement mat. (TRM) A rolled erosion control product composed of non-degradable synthetic fibers, filaments, nets, wire mesh and/or other elements, processed into a permanent, three-dimensional matrix of sufficient thickness. TRMs, which may be supplemented with degradable components, are designed to impart immediate erosion protection, enhance vegetation establishment and provide long-term functionality by permanently reinforcing vegetation during and after maturation. Note: TRMs are typically used in hydraulic applications, such as high flow ditches and channels, steep slopes, stream banks, and shorelines, where erosive forces may exceed the limits of natural, un-reinforced vegetation or in areas where limited vegetation establishment is anticipated.

### ***Design Considerations for degradable RECPs***

Given the wide variety of RECPs available, it is impossible to cover the design considerations for each type of product herein. Therefore, it is recommended that the designer contact a manufacturer to obtain the appropriate information. Many manufacturers provide design software and/or a RECP product selection guide through their company website. Also, the Erosion Control Technology Council (ECTC) is an organization representing suppliers and manufacturers of rolled erosion control products. ([www.ectc.org](http://www.ectc.org)) The construction specifications that follow are from that organization.

### **Tables 1 and 2 provide guidance on the selection of appropriate RECPs for various situations.**

For channel applications, the final permanent grass lining planned for the channel should be analyzed for the 10-year storm in the permanent vegetated state. The RECP should also be analyzed for shear stress. This analysis should be for the unvegetated state, representing the situation immediately after installation. Since it is considered a temporary measure, stabilizing the channel only until vegetation is established, the RECP does not need to be analyzed for a 10-year event as the vegetation

does. Analyses of the RECP's shear strength for a 2-year event is adequate.

### ***Design Considerations for TRMs***

There is also a wide variety of TRMs available so it is impossible to cover the specific design considerations of each product. However, most TRM products are designed, tested, and rated for resistance to shear stress. As with all permanent channels use the peak flows from a 10-year/24-hour storm event.

Shear stress in channels lined with TRMs is calculated in the same manner as for grass channels. If the channel is to be vegetated, a variable Manning coefficient will need to be calculated. If the channel is being analyzed for performance with the TRM alone, a constant Manning coefficient, provided by the manufacturer, may be used..

After calculating the shear stress in the channel, an appropriate TRM able to withstand the anticipated shear stress can be selected. Most TRM manufacturers have software available to aid in the calculation of shear stress and the selection of an appropriate TRM. This software may be available through the manufacturer's website or local product representative.

TRMs should always be installed in accordance with the manufacturer's recommendations.

### ***Construction Specifications***

This specification is intended to provide general guidelines for the installation of RECPs and does not supersede manufacturer's guidelines. The following sections summarize the general, accepted procedures for installation of RECPs and provide basic guidance for slope and channel installations. Detailed design/installation information should be obtained from the manufacturer.

**General Procedure.** Prepare a stable and firm soil surface free of rocks and other obstructions. Apply soil amendments as necessary to prepare seedbed. Apply seed and fertilizer in accordance with the Permanent Seeding Specification. Typically, RECPs are unrolled parallel to the primary direction of flow. Ensure the product maintains intimate contact with the soil surface over the entirety of the installation. Do not stretch or allow material to bridge over surface inconsistencies. Staple/stake RECPs to soil such that each staple/stake is flush with underlying soil. Install anchor trenches, seams and terminal ends as specified.

Install RECPs after application of seed, fertilizer, mulches (if necessary) and other necessary soil amendments, unless soil in-filling of the TRM is required. For TRMs if soil in-filling, install TRM, apply seed, and other soil amendments lightly brush or rake 0.3 to 0.7 in. of topsoil into TRM matrix to fill the product thickness. If in-filling with a hydraulically-



applied matrix or medium is required; install TRM, then install hydraulically-applied matrix or medium at the manufacturer's suggested application rate.

Apply MCNs (Materials Type 1.A., 2.A., 3.A.) immediately after dry mulch application.

### **Anchor Trenches, Seams and Terminal Ends**

- (A) **Anchor Trenches** – Utilize one of the methods detailed below for initial anchoring of RECPs:
1. Staples. Install the RECPs 3 ft. beyond the shoulder of the slope onto flat final grade. Secure roll end with a single row of stakes/staples on 1 ft. centers.
  2. Anchor trench. Excavate a 6 in. by 6 in. (150 mm by 150 mm) anchor trench. Extend the upslope terminal end of the RECPs 3 ft. past the anchor trench. Use stakes or staples to fasten the product into the bottom of the anchor trench on 1 ft. centers. Backfill the trench and compact the soil into the anchor trench. Apply seed and any necessary soil amendments to the compacted soil and cover with remaining 1 ft. terminal end of the RECPs. Secure terminal end of RECPs with a single row of stakes or staples on 1 ft. centers.
  3. Check slot. Construct a stake/staple check slot along the top edge of the RECPs by installing two rows of staggered stakes/staples 4 in. apart on 4 in. centers.
- (B) **Seams** – Utilize one of the methods detailed below for seaming of RECPs:
1. Adjacent seams. Overlap edges of adjacent RECPs by 6 in. or by abutting products as defined by manufacturer. Use a sufficient number of stakes or staples to prevent seam or abutted rolls from separating.
  2. Consecutive rolls. Shingle and overlap consecutive rolls 6 in. in the direction of flow. IE Cover the downslope roll with the next upslope roll.
  3. Check seam. Construct a stake/staple check seam along the top edge of RECPs for slope application and at specified intervals in a channel by installing two staggered rows of stakes/staples 4 in. apart on 4 in. centers.
- (C) **Terminal Ends** – Utilize one of the methods detailed below for all terminal ends of RECPs:
1. Staples. Install the RECPs 3 ft. beyond the end of the channel and secure end with a single row of stakes/staples on 1 ft. centers. Stakes/staples for securing

RECPs to the soil are typically 6 in. long. Use longer staples in sandy soils.

2. Anchor trench. Excavate a 6 in. by 6 in. anchor trench. Extend the terminal end of the RECPs 3 ft. past the anchor trench. Use stakes or staples to fasten the product into the bottom of the anchor trench on 1 ft. centers. Backfill the trench and compact the soil into the anchor trench. Apply seed and any necessary soil amendments to the compacted soil and cover with remaining 1 ft. terminal end of the RECPs. Secure terminal end of RECPs with a single row of stakes or staples on 1 ft. centers.
3. Check slot. Construct a stake/staple check slot along the terminal end of the RECPs by installing two rows of staggered stakes/staples 4 in. apart on 4 in. centers.

**Slope Installations.** At the top of slope, anchor the RECPs according to one of the method detailed in Section (A) above. Securely fasten all RECPs to the soil by installing stakes/staples at a minimum rate of 1.5/yd<sup>2</sup>. For the most effective RECP installation use stake/staple patterns and densities as recommended by the manufacturer. For adjacent and consecutive rolls of RECPs follow seaming instructions detailed in Section (B) above. The terminal end of the RECPs installation must be anchored using one of the methods detailed in Section (C) above.

**Channel Installations.** Construct an anchor trench at the beginning of the channel across its entire width according to Section (A) (2) above. Follow the manufacturer's installation guidelines in constructing additional anchor trenches or stake/staple check slots at intervals along the channel reach and at the terminal end of the channel, according to paragraph (A) above respectively. Unroll RECPs down the center of the channel in the primary water flow direction. Securely fasten all RECPs to the soil by installing stakes/staples at a minimum rate of 2/yd<sup>2</sup>. Significantly higher anchor rates and longer stakes/staples may be necessary in sandy, loose, or wet soils and in severe applications. For adjacent and consecutive rolls of RECPs follow seaming instructions detailed in Section (B) above. All terminal ends of the RECPs must be anchored using one of the methods detailed in Section (C) above.

With any RECP installation, ensure sufficient staples to resist uplift from hydraulics, wind, mowers, and foot traffic. For the most effective installation of RECPs, it is recommended to use stake/staple patterns and densities as recommended by the manufacturer.

### ***Maintenance***

During the initial period after installation inspect once at week or after every rain of 0.5" or more. Basic monitoring should consist of visual inspections to determine mat integrity and attachment performance. Rill development beneath the mat or edge lifting is evidence of inadequate attachment.

Until the vegetation is fully established, the ground surface should be inspected for signs of rill or gully erosion below the matting. Any signs of erosion, tearing of the matting, or areas where the matting is no longer anchored firmly to the ground should be repaired. Repair any damaged areas immediately by restoring soil to finished grade, re-applying soil amendments and seed, and replacing the RECPs. Additional staking and trenching can be employed to correct defects. Recently placed mats may be replaced, but once vegetation becomes established, replacement is not a reasonable option unless large failures have occurred. If the RECPs are vegetated, the vegetation should be watered as needed. Getting grass established as quickly as possible is very important.

**Table 3.13.1 ECTC STANDARD SPECIFICATION FOR TEMPORARY ROLLED EROSION CONTROL PRODUCTS**

For use where natural vegetation alone will provide permanent erosion protection.

<b>ULTRA SHORT-TERM - Typical 3 month functional longevity.</b>						
Type	Product Description	Material Composition	Slope Applications*		Channel Applications*	Minimum
			Maximum Gradient	C Factor <sup>2,5</sup>	Max. Shear Stress <sup>3,4,6</sup>	Tensile Strength <sup>1</sup>
1.A	Mulch Control Nets	A photodegradable synthetic mesh or woven biodegradable natural fiber netting.	5:1 (H:V)	≤ 0.10 @ 5:1	0.25 lbs/ft <sup>2</sup> (12 Pa)	5 lbs/ft (0.073 kN/m)
1.B	Netless Rolled Erosion Control Blankets	Natural and/or polymer fibers mechanically interlocked and/or chemically adhered together to form a RECP.	4:1 (H:V)	≤ 0.10 @ 4:1	0.5 lbs/ft <sup>2</sup> (24 Pa)	5 lbs/ft (0.073 kN/m)
1.C	Single-net Erosion Control Blankets & Open Weave Textiles	Processed degradable natural and/or polymer fibers mechanically bound together by a single rapidly degrading, synthetic or natural fiber netting or an open weave textile of processed rapidly degrading natural or polymer yarns or twines woven into a continuous matrix.	3:1 (H:V)	≤ 0.15 @ 3:1	1.5 lbs/ft <sup>2</sup> (72 Pa)	50 lbs/ft (0.73 kN/m)
1.D	Double-net Erosion Control Blankets	Processed degradable natural and/or polymer fibers mechanically bound together between two rapidly degrading, synthetic or natural fiber nettings.	2:1 (H:V)	≤ 0.20 @ 2:1	1.75 lbs/ft <sup>2</sup> (84 Pa)	75 lbs/ft (1.09 kN/m)
<b>SHORT-TERM - Typical 12 month functional longevity.</b>						
Type	Product Description	Material Composition	Slope Applications*		Channel Applications*	Minimum
			Maximum Gradient	C Factor <sup>2,5</sup>	Max. Shear Stress <sup>3,4,6</sup>	Tensile Strength <sup>1</sup>
2.A	Mulch Control Nets	A photodegradable synthetic mesh or woven biodegradable natural fiber netting.	5:1 (H:V)	≤ 0.10 @ 5:1	0.25 lbs/ft <sup>2</sup> (12 Pa)	5 lbs/ft (0.073 kN/m)
2.B	Netless Rolled Erosion Control Blankets	Natural and/or polymer fibers mechanically interlocked and/or chemically adhered together to form a RECP.	4:1 (H:V)	≤ 0.10 @ 4:1	0.5 lbs/ft <sup>2</sup> (24 Pa)	5 lbs/ft (0.073 kN/m)
2.C	Single-net Erosion Control Blankets & Open Weave Textiles	An erosion control blanket composed of processed degradable natural or polymer fibers mechanically bound together by a single degradable synthetic or natural fiber netting to form a continuous matrix or an open weave textile composed of processed degradable natural or polymer yarns or twines woven into a continuous matrix.	3:1 (H:V)	≤ 0.15 @ 3:1	1.5 lbs/ft <sup>2</sup> (72 Pa)	50 lbs/ft (0.73 kN/m)
2.D	Double-net Erosion Control Blankets	Processed degradable natural and/or polymer fibers mechanically bound together between two degradable, synthetic or natural fiber nettings.	2:1 (H:V)	≤ 0.20 @ 2:1	1.75 lbs/ft <sup>2</sup> (84 Pa)	75 lbs/ft (1.09 kN/m)
<b>EXTENDED-TERM - Typical 24 month functional longevity.</b>						
Type	Product Description	Material Composition	Slope Applications*		Channel Applications*	Minimum
			Maximum Gradient	C Factor <sup>2,5</sup>	Max. Shear Stress <sup>3,4,6</sup>	Tensile Strength <sup>1</sup>
3.A	Mulch Control Nets	A slow degrading synthetic mesh or woven natural fiber netting.	5:1 (H:V)	≤ 0.10 @ 5:1	0.25 lbs/ft <sup>2</sup> (12 Pa)	25 lbs/ft (0.36 kN/m)
3.B	Erosion Control Blankets & Open Weave Textiles	An erosion control blanket composed of processed slow degrading natural or polymer fibers mechanically bound together between two slow degrading synthetic or natural fiber nettings to form a continuous matrix or an open weave textile composed of processed slow degrading natural or polymer yarns or twines woven into a continuous matrix.	1.5:1 (H:V)	≤ 0.25 @ 1.5:1	2.00 lbs/ft <sup>2</sup> (96 Pa)	100 lbs/ft (1.45 kN/m)
<b>LONG-TERM - Typical 36 month functional longevity.</b>						
Type	Product Description	Material Composition	Slope Applications*		Channel Applications*	Minimum
			Maximum Gradient	C Factor <sup>2,5</sup>	Max. Shear Stress <sup>3,4,6</sup>	Tensile Strength <sup>1</sup>
4	Erosion Control Blankets & Open Weave Textiles	An erosion control blanket composed of processed slow degrading natural or polymer fibers mechanically bound together between two slow degrading synthetic or natural fiber nettings to form a continuous matrix or an open weave textile composed of processed slow degrading natural or polymer yarns or twines woven into a continuous matrix.	1:1 (H:V)	≤ 0.25 @ 1:1	2.25 lbs/ft <sup>2</sup> (108 Pa)	125 lbs/ft (1.82 kN/m)

\* "C" factor and shear stress for Types 1.A., 2.A. and 3.A mulch control nettings must be obtained with netting used in conjunction with pre-applied mulch material.

<sup>1</sup> Minimum Average Roll Values, Machine direction using ECTC Mod. ASTM D 5035.

<sup>2</sup> "C" Factor calculated as ratio of soil loss from RECP protected slope (tested at specified or greater gradient, h:v) to ratio of soil loss from unprotected (control) plot in large-scale testing. These performance test values should be supported by periodic bench scale testing under similar test conditions using Erosion Control Technology Council (ECTC) Test Method # 2.

<sup>3</sup> Required minimum shear stress RECP (unvegetated) can sustain without physical damage or excess erosion (> 12.7 mm (0.5 in) soil loss) during a 30-minute flow event in large-scale testing. These performance test values should be supported by periodic bench scale testing under similar test conditions and failure criteria using Erosion Control Technology Council (ECTC) Test Method #3.

<sup>4</sup> The permissible shear stress levels established for each performance category are based on historical experience with products characterized by Manning's roughness coefficients in the range of 0.01 - 0.05.

<sup>5</sup> Acceptable large-scale test methods may include ASTM D6459, Erosion Control Technology Council (ECTC) Test Method # 2, or other independent testing deemed acceptable by the engineer.

<sup>6</sup> Per the engineers discretion. Recommended acceptable large-scale testing protocol may include ASTM D6460, Erosion Control Technology Council (ECTC) Test Method #3 or other independent testing deemed acceptable by the engineer.

**Table 3.13.2 ECTC STANDARD SPECIFICATION FOR PERMANENT ROLLED EROSION CONTROL PRODUCTS**

For applications where vegetation alone will not sustain expected flow conditions and/or provide sufficient long-term erosion protection.

<b>Permanent<sup>1</sup></b> - All categories of TRMs must have a minimum thickness of 0.25 inches (6.35 mm) per ASTM D 6525 and U.V. stability of 80% per ASTM D 4355 (500 hours exposure).					
<b>Type</b>	<b>Product Description</b>	<b>Material Composition</b>	<b>Slope Applications Maximum Gradient</b>	<b>Channel Applications Maximum Shear Stress<sup>4,5</sup></b>	<b>Minimum Tensile Strength<sup>2,3</sup></b>
<b>5.A</b>	Turf Reinforcement Mat	Turf Reinforcement Mat (TRM) – A rolled erosion control product composed of non-degradable synthetic fibers, filaments, nets, wire mesh and/or other elements, processed into a permanent, three-dimensional matrix of sufficient thickness. TRMs, which may be supplemented with degradable components, are designed to impart immediate erosion protection, enhance vegetation establishment and provide long-term functionality by permanently reinforcing vegetation during and after maturation. Note: TRMs are typically used in hydraulic applications, such as high flow ditches and channels, steep slopes, stream banks, and shorelines, where erosive forces may exceed the limits of natural, unreinforced vegetation or in areas where limited vegetation establishment is anticipated.	0.5:1 (H:V)	6.0 lbs/ft <sup>2</sup> (288 Pa)	125 lbs/ft (1.82 kN/m)
<b>5.B</b>	Turf Reinforcement Mat		0.5:1 (H:V)	8.0 lbs/ft <sup>2</sup> (384 Pa)	150 lbs/ft (2.19 kN/m)
<b>5.C</b>	Turf Reinforcement Mat		0.5:1 (H:V)	10.0 lbs/ft <sup>2</sup> (480 Pa)	175 lbs/ft (2.55 kN/m)

<sup>1</sup> For TRMs containing degradable components, all property values must be obtained on the non-degradable portion of the matting alone.

<sup>2</sup> Minimum Average Roll Values, machine direction only for tensile strength determination using ASTM D6818 (Supercedes Mod. ASTM D5035 for RECPs)

<sup>3</sup> Field conditions with high loading and/or high survivability requirements may warrant the use of a TRM with a tensile strength of 44 kN/m (3,000 lb/ft) or greater.

<sup>4</sup> Required minimum shear stress TRM (fully vegetated) can sustain without physical damage or excess erosion (> 12.7 mm (0.5 in.) soil loss) during a 30-minute flow event in large scale testing. These performance test values should be supported by periodic bench scale testing under similar test conditions and failure criteria using Erosion Control Technology Council (ECTC) Test Method #3.

<sup>5</sup> Acceptable large-scale testing protocol may include ASTM D6460, Erosion Control Technology Council (ECTC) Test Method #3, or other independent testing deemed acceptable by the engineer

**Table 3.13.3 PERMISSIBLE VELOCITIES FOR EARTH LININGS**

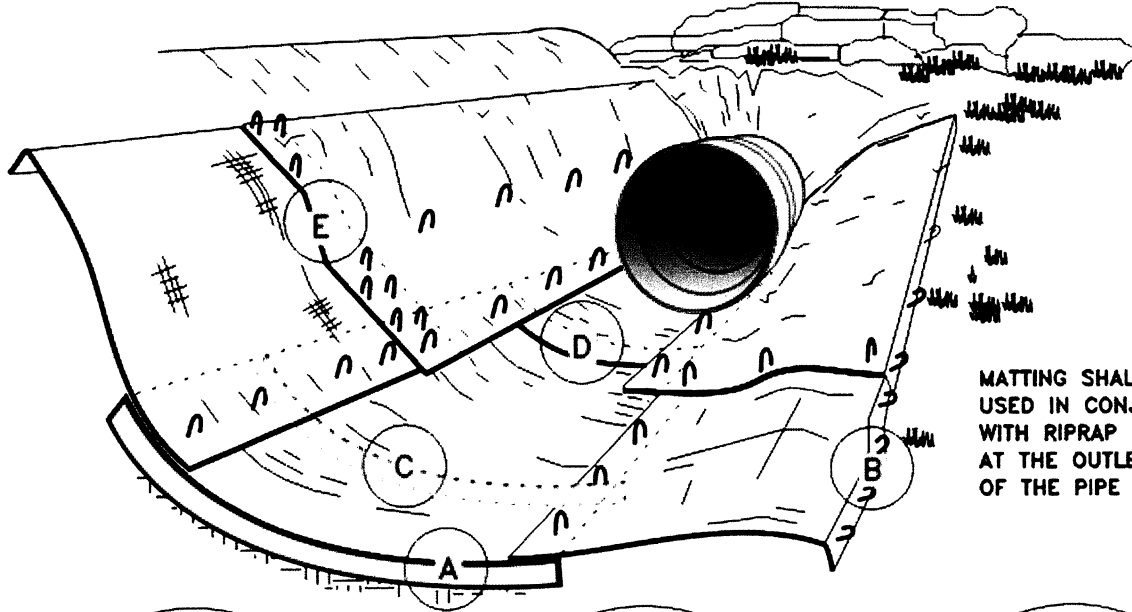
Soil Types	Permissible Velocities (ft./sec.)
Fine Sand (noncolloidal)	2.5
Sandy Loam (noncolloidal)	2.5
Silt Loam (noncolloidal)	3.0
Ordinary Firm Loam	3.5
Fine Gravel	5.0
Stiff Clay (very colloidal)	5.0
Graded, Loam to Cobbles (noncolloidal)	5.0
Graded, Silt to Cobbles (colloidal)	5.5
Alluvial Silts (noncolloidal)	5.5
Alluvial Silts (colloidal)	5.0
Coarse Gravel (noncolloidal)	6.0
Cobbles and Shingles	5.5
Shales and Hard Plans	6.0

**Table 3.13.4 PERMISSIBLE VELOCITIES FOR GRASS-LINED CHANNELS**

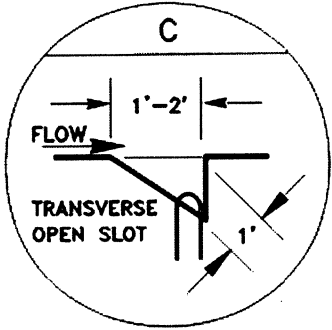
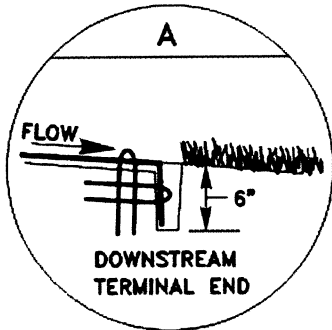
Channel Slope	Lining	Velocity* (ft./sec.)
0 - 0.5%	Bermudagrass	6
	Reed canarygrass Tall fescue Kentucky bluegrass	5
	Grass-legume mixture	4
	Red fescue Redtop Sericea lespedeza Annual lespedeza Small grains Temporary vegetation	2.5
	Bermudagrass	5
5 - 10%	Reed canarygrass Tall fescue Kentucky bluegrass	4
	Grass-legume mixture	3
	Bermudagrass	4
	Reed canarygrass Tall fescue Kentucky bluegrass	3
Greater than 10%	Bermudagrass	4
	Reed canarygrass Tall fescue Kentucky bluegrass	3
* For highly erodible soils, decrease permissible velocities by 25%.		

FIGURE 3.13.1

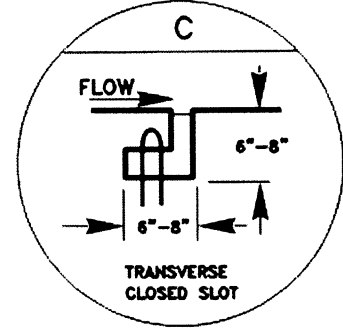
# TYPICAL RECP CHANNEL INSTALLATION



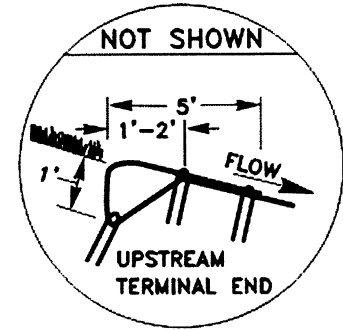
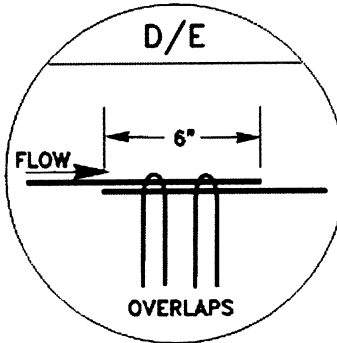
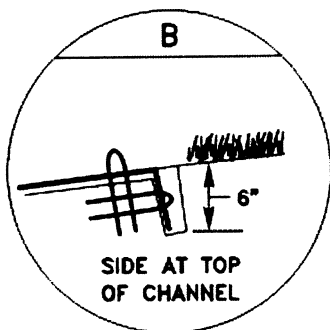
MATting SHALL BE USED IN CONJUNCTION WITH RIPRAP (NOT SHOWN) AT THE OUTLET END OF THE PIPE



OR



THESE CONFIGURATIONS ARE EXAMPLES ONLY  
ALWAYS INSTALL PER MANUFACTURER'S RECOMMENDATIONS



SOURCE: VIRGINIA DCR-DSWC AND NORTH AMERICAN GREEN

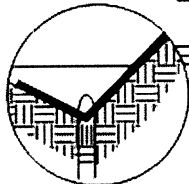
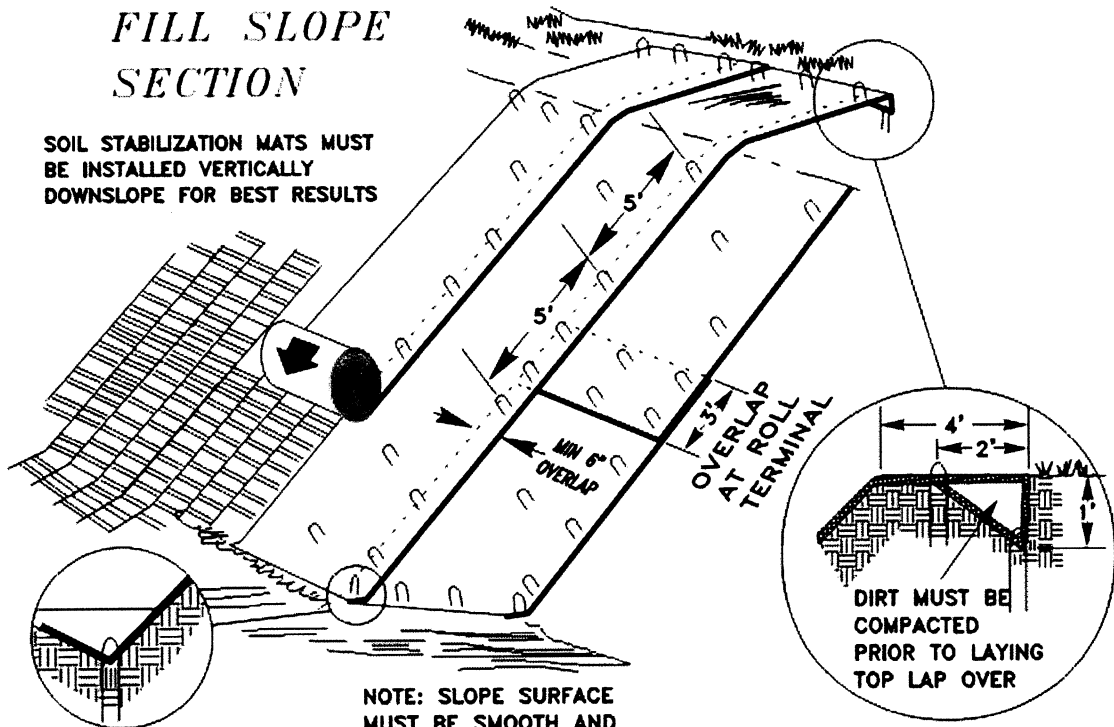


FIGURE 3.13.2

# ROLLED EROSION CONTROL PRODUCTS

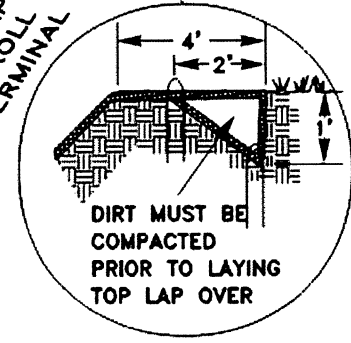
## FILL SLOPE SECTION

SOIL STABILIZATION MATS MUST BE INSTALLED VERTICALLY DOWNSLOPE FOR BEST RESULTS



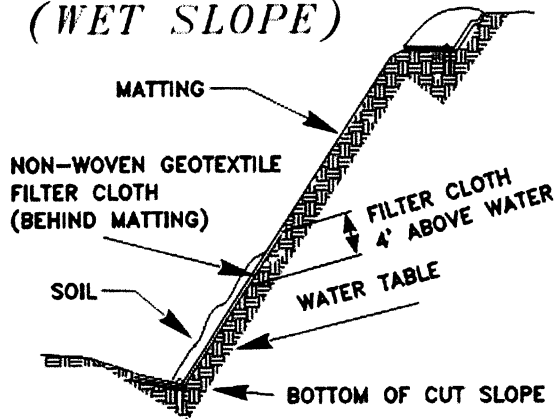
**TOE**  
MAINTAIN  
SLOPE ANGLE

NOTE: SLOPE SURFACE MUST BE SMOOTH AND FREE OF ROCKS, LUMPS, GRASS AND STICKS. MAT MUST BE PLACED FLAT ON SURFACE FOR PROPER SOIL CONTACT

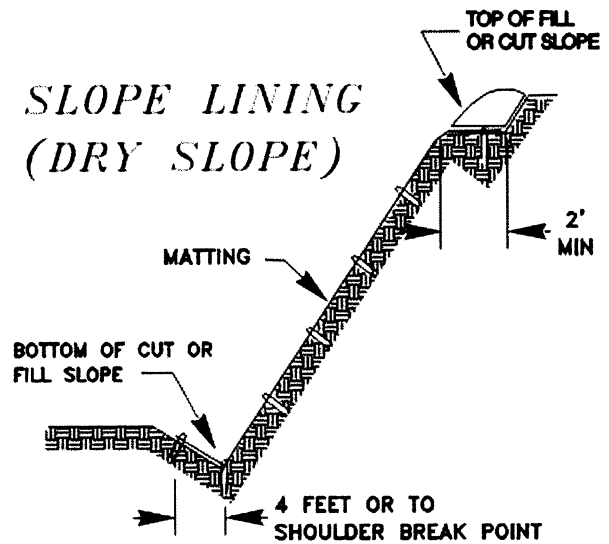


**TOP**  
TRENCH INTO BERM AND INSTALL FROM TOP TO THE BOTTOM

## SLOPE LINING (WET SLOPE)



## SLOPE LINING (DRY SLOPE)



SOURCE: VDOT STANDARDS AND VIRGINIA DCR-DSWC

## 3.14 - SODDING

---

### ***Introduction***

The purpose of sodding is to establish permanent turf for immediate erosion protection and to stabilize drainage ways where concentrated overland flow will occur.

### ***Conditions Where Practice Applies***

Sodding may be used in the following areas:

1. Disturbed areas that require short-term or long-term cover
2. Disturbed areas that require immediate vegetative cover
3. All waterways that require vegetative lining. Waterways may also be seeded rather than sodded and protected with a RECP.

### ***Design***

#### ***Consideration***

Sod shall be free of weeds, of uniform thickness (approximately 1-inch thick), and shall have a dense root mat for mechanical strength.

#### ***Construction Specifications***

The following steps are recommended for sod installation:

1. Shape and smooth the surface to final grade in accordance with the approved grading plan.
2. Amend two inches (minimum) of well-rotted compost into the top six inches of the soil if the organic content of the soil is less than 10 percent.
3. Fertilize according to the supplier's recommendations. Disturbed areas within 200 feet of waterbodies and wetlands must use non-phosphorus fertilizer.
4. Work lime and fertilizer one to two inches into the soil, and smooth the surface.
5. Lay strips of sod beginning at the lowest area to be sodded and perpendicular to the direction of water flow. Wedge strips securely into place. Square the ends of each strip to provide for a close, tight fit.
6. Stagger joints at least 12 inches. Staple on slopes steeper than 3:1. Roll the sodded area and irrigate.
7. When sodding is carried out in alternating strips or other patterns, seed the areas between the sod immediately after sodding.

### ***Maintenance***

If the grass is unhealthy, the cause shall be determined and appropriate action taken to reestablish a healthy groundcover. If it is impossible to establish a healthy groundcover due to frequent saturation, instability or some other cause, the sod shall be removed, the area seeded with an appropriate mix, and protected with a net or blanket.

## 3.15 - TEMPORARY DIVERSION

---

### ***Introduction***

A temporary berm or excavated channel or combination berm and channel constructed across sloping land on a predetermined grade. This variable practice is used to protect work areas from upslope runoff and reduce the size of the drainage area going to sediment trapping structures, transport runoff across a project to minimize erosion and to divert sediment-laden water to an appropriate sediment trapping facility.

### ***Conditions Where Practice Applies***

This practice applies to construction areas where runoff can be diverted and disposed of properly to control erosion, sedimentation, or flood damage. Specific locations and conditions can include the following:

1. To divert upslope clean water around a construction site to reduce the quantity of water within the sediment control system. Also called a clean water ditch or upslope diversion.
2. To shorten or reduce the length of the slope that runoff will cross. (see also RIGHT OF WAY DIVERSION and the WATER CONTROL sections)
3. To divert upslope water from disturbed areas such as cut or fill slopes to a stabilized outlet or if sediment laden, to a sediment trapping device. Similar in concept to upslope diversion.
5. To divert sediment laden water at or near the perimeter of the construction area to either a sediment basin or a sediment trap. Also called a dirty water ditch or perimeter ditch.
6. To divert internal sediment laden water to a sediment-trapping structure or a stable internal waterway.
7. Above critical disturbed areas before stabilization to prevent erosion and maintain acceptable working conditions
8. To divert water away from footers, walls, and other structures.

### ***Design Considerations***

It is important that diversions are properly designed, constructed and maintained since they concentrate water flow and increase erosion potential. Temporary diversions must be designed and installed so they stable throughout their useful life and to meet the criteria given in this section. Particular care must be taken in planning diversion grades. Too much slope can result in erosion in the diversion channel. This is especially true at the entrance to a sediment trapping structure. Conversely, a reduction in grade will cause sediment to be deposited, plugging the channel. The blockage may cause failure by overtopping and the discharge of sediment-laden runoff off site.

Frequent inspection and timely maintenance are essential to the proper functioning of diversions. Sufficient area should be available to construct and properly maintain diversions.

It is usually less costly to excavate a channel and form a ridge or dike on the downhill side with the spoil than to build diversions by other methods. Where space is limited, it may be necessary to build the ridge by hauling in the berm material. If the diversion is located where construction traffic will cross, stabilize the channel and berm with stone. If there will be extensive traffic it will be necessary to install a temporary culvert.

Whenever possible, install dirty water diversions in conjunction with the construction of the sediment trapping structure prior clearing and grubbing. Install other types diversions as needed.

Because diversions collect overland flow, changing it into concentrated flows, they can create an additional erosion hazard. In areas of highly erodible soils it may be necessary to armor the channel with riprap. This will be necessary especially in the transition into a sediment trap or basin and on slopes over 10 percent.

For longer slopes, several dikes or swales are placed across the slope at intervals. This practice reduces the amount of runoff that accumulates on the face of the slope and carries the runoff safely down the slope.

Diversion may create difficulties in establishing vegetation if water flow is too fast or ponds.

Poorly laid out and constructed diversion require unnecessary additional maintenance, inspections, and repairs.

Interceptor dikes and swales can be permanent controls. However, permanent controls: must be designed to handle runoff after construction is complete, must be permanently stabilized, and should be inspected and maintained on a regular basis.

If the watershed drained by the diversion is unstabilized at any time, the diversion must lead to a sediment-trapping device.

**General design criteria:**

1. Drainage area should not exceed five acres.
2. The minimum cross section should be adequate for the anticipated flows but at a minimum must handle the peak discharge from a 2-year/24-hour storm.
3. The grade may be variable depending upon the topography and must have a positive grade along its entire length. The maximum channel grade should be limited to 5.0 percent.
5. Diverted runoff must outlet onto a stabilized area, into a properly designed waterway, grade stabilization structure or sediment trapping facility.
6. Diversions that are to serve longer than 14 working days shall be stabilized immediately with seed and mulch with or without a

RECP meeting the requirements found in this manual to preserve dike height, prevent erosion and reduce maintenance.

7. The channel cross section may be parabolic, v-shaped or trapezoidal.

### **Specific Design Criteria**

1. Temporary (less than 6 months) diversions must be designed to handle the peak discharge from a 2-year/24-hour storm with 0.3 ft. of freeboard.
2. A long term (more than 6 months) or permanent diversion must have a minimum capacity to carry the runoff expected from a 10-year/24-hour frequency storm with a freeboard of at least 0.3 foot (see drawing)
3. Diversions designed to protect homes, schools, industrial buildings, roads, parking lots, and comparable high-risk areas, and those designed to function in connection with other structures, shall have sufficient capacity to carry peak runoff expected from a storm frequency consistent with the hazard involved.

**Channel** The diversion channel may be parabolic, trapezoidal or vee-shaped.

**Berm/dike Design** The supporting ridge cross section shall meet the following criteria (also see drawings):

1. The side slopes shall be no steeper than 2:1.
2. The width at the design water elevation should be a minimum of 4 feet.
3. The minimum freeboard shall be 0.3 foot.
4. The design of the berm/dike shall include a 10 percent settlement factor.

**Outlet:** Diversions shall have stabilized outlets that release the concentrated runoff without causing erosion. Acceptable outlets for sediment free runoff include a permanently stabilized stormwater conveyance channel, Level Lip Spreader, drop inlet structure, underground stormwater system, Outlet Protection or natural waterway.

All except the most short-lived diversions, all diversions must be stabilized according to the anticipated velocity and erodibility of the soil and the ability of the lining to protect the channel from eroding. Stabilization measures include, grass, grass with a RECP, RECP alone if designed for this purpose, and riprap. The following charts give basic minimum design for the dimensions and the maximum permissible velocities for various linings and soil types. See the section on RECPs for additional information on how to select the appropriate material and the correct installation techniques. If conditions exceed the requirements noted above and in the charts, the channel and lining must be professionally designed.

<b>Table 3.15.1 CHANNEL CROSS SECTION REQUIREMENTS</b>		
	<b>A</b>	<b>B</b>
Drainage area	< 5 acres	5 – 10 acres
Bottom width flow channel	4 feet	6 feet
Depth of flow channel	1 foot	1 foot
Side slopes	2:1 or flatter	2:1 or flatter
Grade	0.5% minimum	0.5% minimum

<b>Table 3.15.2 CHANNEL STABILIZATION REQUIREMENTS</b>		
<b>channel Grade (%)</b>	<b>A &lt; 5 acres</b>	<b>B 5 – 10 acres</b>
0.5 – 3.0	Seed & straw mulch	Seed & straw mulch
3.1 – 5.0	Seed & straw mulch	Seed & cover /RECP; sod; or line with riprap
5.1 – 8.0	Seed & cover w/ RECP; sod;or line with riprap	Line with riprap
8.1 – 20.0	Line with riprap	Engineering design

<b>Table 3.15.3</b> <b>PERMISSIBLE VELOCITIES FOR</b> <b>GRASS-LINED CHANNELS</b>		
Channel Slope	Grass Species	Velocity* (ft./sec.)
0 - 0.5%	Bermudagrass	6
	Reed canarygrass Tall fescue Kentucky bluegrass	5
	Grass-legume mixture	4
	Red fescue Redtop Sericea lespedeza Annual lespedeza Small grains Temporary vegetation	2.5
5 - 10%	Bermudagrass	5
	Reed canarygrass Tall fescue Kentucky bluegrass	4
	Grass-legume mixture	3
Greater than 10%	Bermudagrass	4
	Reed canarygrass Tall fescue Kentucky bluegrass	3
* For highly erodible soils, decrease permissible velocities by 25%.		

For vegetated earth channels having permanent turf reinforcement matting, the permissible flow velocity shall not exceed 8 ft/sec. Turf reinforcement matting shall meet the requirements in the Section on RECPs.

An erodibility factor (K) greater than 0.35 would indicate a highly erodible soil. Erodibility factors (K-factors) can be obtained from local NRCS offices.

**Table 3.15.4 MAXIMUM PERMISSIBLE DESIGN VELOCITIES**

<b>Soil Texture</b>	<b>Channel Vegetation Retardance and Cover</b>	<b>Permissible Velocities (ft./sec.)</b>
<b>Sand, silt, sandy loam, silt loam, loamy sand</b>	Tall fescue, smooth brome grass	3.5
	Kentucky bluegrass, redtop, red fescue	3.0
	Annuals 2/, small grain (rye, oats, wheat, ryegrass)	2.5
	Bare channel	1.5
<b>Silty clay loam, sandy clay loam</b>	Tall fescue, smooth brome grass	4.5
	Kentucky bluegrass, redtop, red fescue	4.0
	Annuals 2/, small grain (rye, oats, wheat, ryegrass)	3.5
	Bare channel	2.0
<b>Clay</b>	Tall fescue, smooth brome grass	5.5
	Kentucky bluegrass, redtop, red fescue	5.0
	Annuals 2/, small grain (rye, oats, wheat, ryegrass)	4.0
	Bare channel	2.0

1/ To be used only in stabilized protected areas.

2/ Annuals – use only as temporary protection until permanent vegetation is established.

These charts are guidelines only. If conditions on the site do not reflect the parameters in the chart it is recommended to provide a full design using HEC-15 or other similar standard. During plan development label all diversions. Example: Two diversions will direct sediment laden water to a sediment trap. Label the sediment trap as trap I and each ditch respectively Ia and Ib. If the diversions are engineered then use these labels on any charts and design sheets.

***Construction Specifications***

1. Clear the area of all trees, brush, stumps or other obstructions.
2. Diversions (upslope and perimeter) must be installed as a first step in the land-disturbing activity and must be functional prior to land disturbance. Diversions may be removed when stabilization of the drainage area and outlet are complete.



3. Runoff from undisturbed areas can be channeled to an existing waterway or to a level lip spreader.
4. Stabilization for the dike and flow channel of the swale should be completed immediately after construction.
5. Stabilization materials can include vegetation, RECP or stone/riprap.
6. When the drainage area to the diversion is greater than 10 acres, standard engineering practices shall be used to properly size the channel.
7. Intercepted sediment laden water must always be diverted to a sediment trap or sediment basin, never silt fence
8. Grades over 10% may require engineering design.
9. Construct the diversions to the designed cross-section, line and grade making sure that there are no irregularities or bank projections to impede the flow.
10. The dike shall be compacted using earth-moving equipment to prevent failure of the dike.
11. Attempt to construct the dike where it will not interfere with major areas of construction traffic so that vehicle damage to the dike will be kept to the minimum. Install culvert crossings anywhere regular construction traffic will cross the channel.
12. The swale must have a positive grade for its entire length. There should be no dips or low points in the swale where storm water will collect and pond.
13. If diversions remain in place longer than 14 days, they are to be properly stabilized.
14. Rock check dams can be installed in the diversion if erosion of the channel appears to be a problem and the channel is deep enough.

### ***Maintenance***

The measure shall be inspected after every storm of more than 0.5 inch and repairs made as necessary. At least once week, the measure shall be inspected and repairs made immediately. Inspect the dike, flow channel and outlet for deficiencies or signs of erosion. Reseed or otherwise stabilize the dike as needed to maintain its stability. Inspect for sediment deposits, constrictions and blockages. Remove any blockage immediately.

Damages caused by construction activities or traffic must be repaired immediately

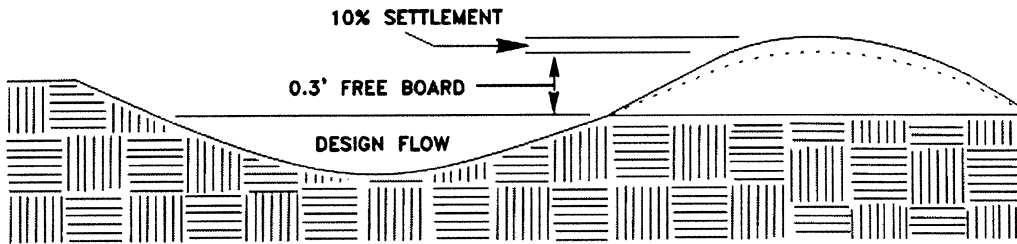
During repairs, properly compacted any material added to the dike.

Vegetated swale channels should be inspected regularly to check for points of scour, bank failure or inadequate vegetative cover; rubbish or channel obstruction; rodent holes or excessive wear from pedestrian or construction traffic. Lined swale channels should be checked regularly for deterioration from freezing, salt or chemicals; scour or undermining at the inlet and outlet; or points of sediment deposition.

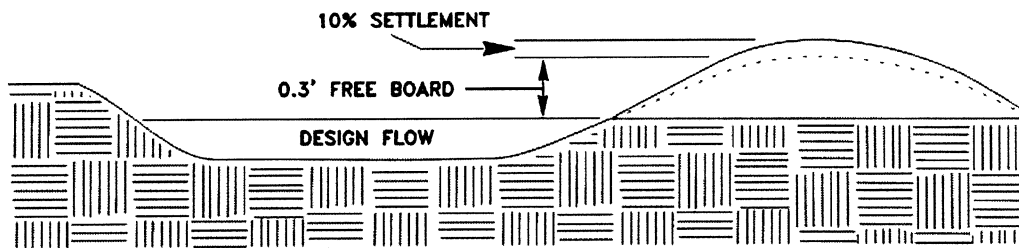
Any needed repairs shall be made promptly.

FIGURE 3.15.1

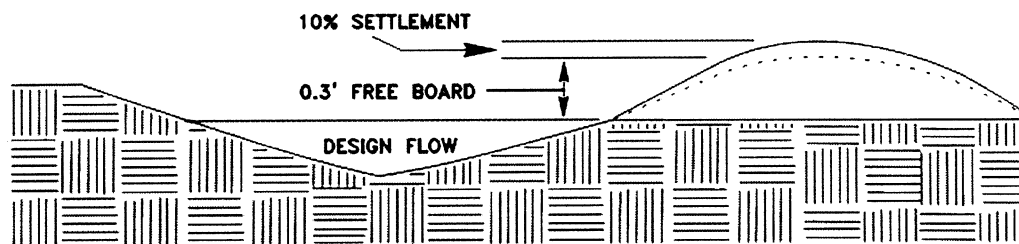
## *TYPICAL DIVERSIONS*



### *PARABOLIC DIVERSION*



### *TRAPEZOIDAL DIVERSION*

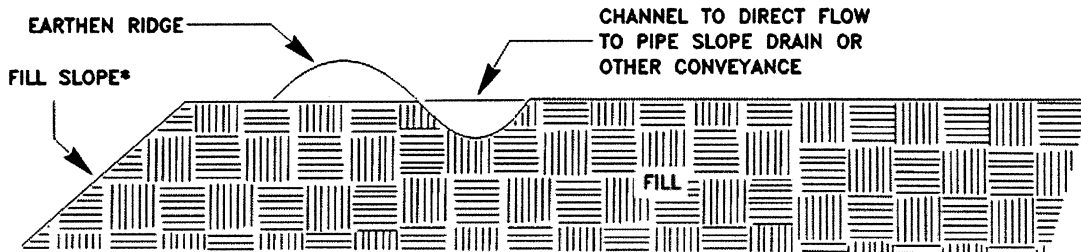


### *VEE-SHAPED DIVERSION*

Source: VIRGINIA DCR-DSWC

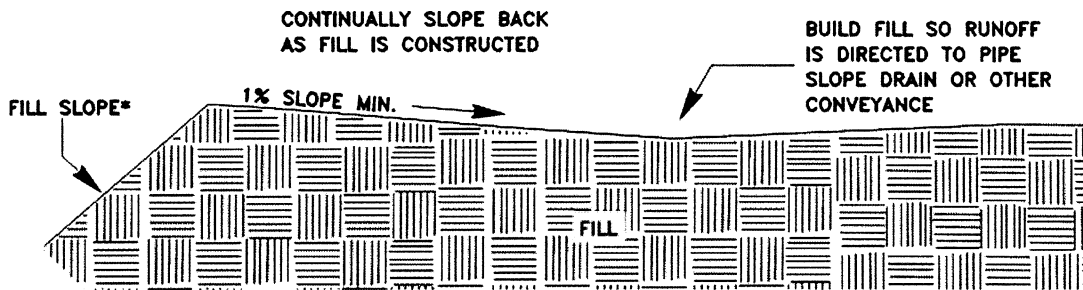
FIGURE 3.15.2

## TEMPORARY FILL DIVERSIONS



## TEMPORARY BERM

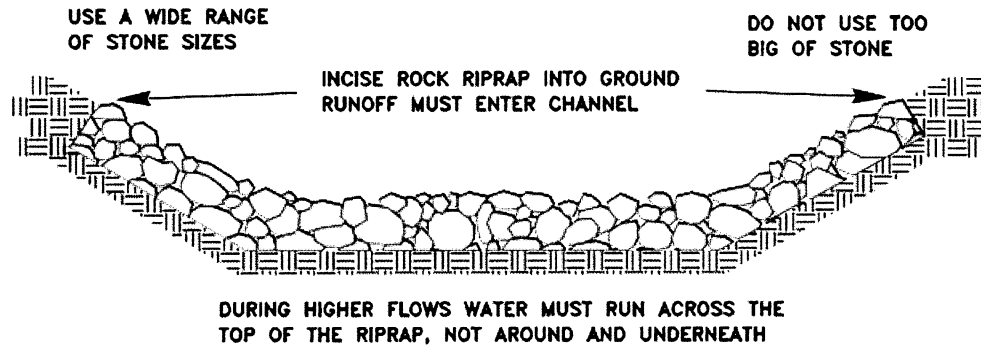
\*SEED AND MULCH FILL SLOPE  
EVERY 10 FEET OF FILL OR  
EVERY 7 DAYS, WHICHEVER  
COMES FIRST



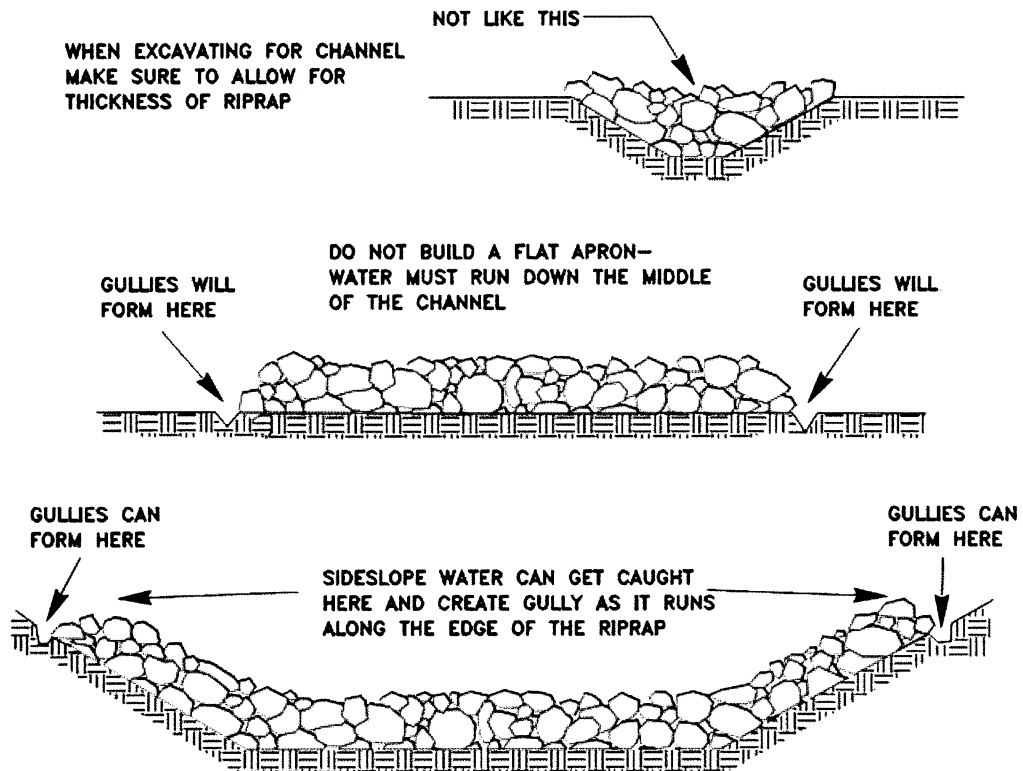
## GRADING

FIGURE 3.15.3

## RIPRAP DIVERSION



## COMMON PROBLEMS



# 3.16 - PIPE SLOPE DRAIN

## **Introduction**

A flexible tubing or conduit extending from the top to the bottom of a cut or fill slope to temporarily conduct concentrated stormwater runoff down the face of the cut or fill in a non-erosive manner.

## **Conditions Where Practice Applies**

There is often a significant lag between the time a cut or fill slope is completed and the time a permanent drainage system can be installed. During this period, the slope is usually not stabilized and is particularly vulnerable to erosion. This situation also occurs on slope construction that is temporarily delayed before final grade is reached. Temporary slope drains can provide valuable protection of exposed slopes until permanent drainage structures can be installed or vegetation can be established.

**Table 3.16.1 PIPE SIZES FOR PIPE SLOPE DRAIN**

Size Diameter (D)	12	18	21	24
Maximum Drainage in Area (Acres)	0.5	1.5	2.5	5.0

Pipe slope drains are used in conjunction with diversions and berms. The diversion/berm direct surface runoff to the slope drain, which conveys concentrated flow down the face of a slope or across a disturbed area. The drainage to a pipe slope drain should be limited to 5 acres.

Because of the height limitation of the berms or diversions, the maximum pipe diameter will be 24".

## **Construction Specifications**

1. The Pipe Slope Drain shall have a slope of 3 percent or steeper.
2. The top of the dike over the inlet pipe shall be at least 8" above the top of the Pipe.
3. Flexible corrugated plastic tubing is preferred. However, corrugated metal pipe or equivalent PVC pipe can be used. All connections shall be watertight.
4. A flared end section can be attached to the inlet end of pipe with a watertight connection. Filter cloth can be placed under the inlet of the pipe slope drain and shall extend out 5 feet from the inlet. The filter cloth shall be entrenched on all sides.
5. The entrance section shall pitch toward the slope at the minimum rate of 1/2 inch per foot.
6. The Pipe Slope Drain shall be securely anchored to the slope by staking at the grommets provided or with straps made specifically for this

purpose. Spacing for anchors shall be as provided by the manufacturer's specification, but no less than 10 feet. In no case shall less than two (2) anchors be provided equally spaced along the length of pipe.

7. The soil around and under the pipe and end section shall be hand tamped in 4-inch lifts to the top of the earth dike.
8. All pipe connections shall be watertight.
9. Where a Pipe Slope Drain drains an unstabilized area, it shall outlet into a SEDIMENT TRAP OR BASIN. If this is not possible then the pipe slope drain will discharge into a stable conveyance that leads to a sediment trap or basin. When discharging into a trap or basin the Pipe Slope Drain shall discharge at the same elevation as the wet pool elevation. The discharge area must be protected from erosion. The discharge from the Pipe Slope Drain must be located at the most distant point from the sediment control device's outlet as possible.
10. When the drainage area is stabilized or undisturbed, the Pipe Slope Drain shall discharge onto a stabilized area at a non-erosive velocity.
11. The Pipe Slope Drain should be placed on undisturbed soil or well-compacted fill.
12. Do not space more than 250 feet apart.
13. A small sediment trap can be installed at the entrance to the pipe if saturation of the fill will not be a problem.

### ***Maintenance***

Inspect and perform any required maintenance once a week and after each 0.5-inch rain event.

The inlet must be kept open at all times. It is very important that these temporary structures be installed properly, since their failure will often result in severe gully erosion on the site and sedimentation below the slope.

The contractor should avoid the placement of any material on and prevent construction traffic across the pipe slope drain.

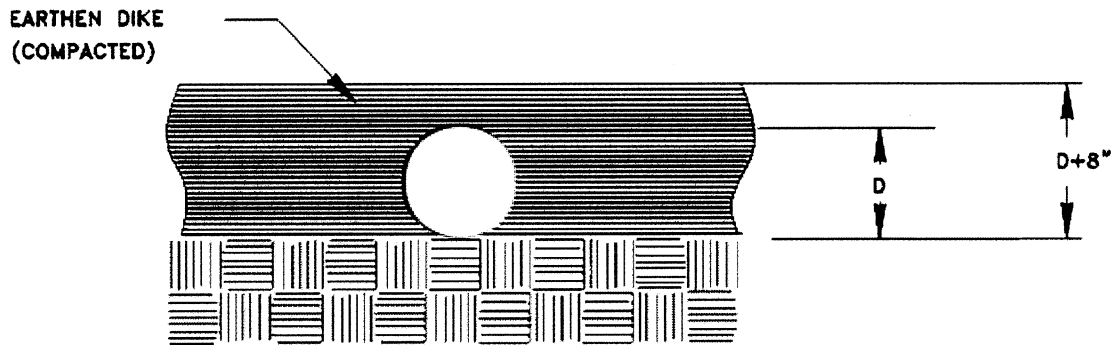
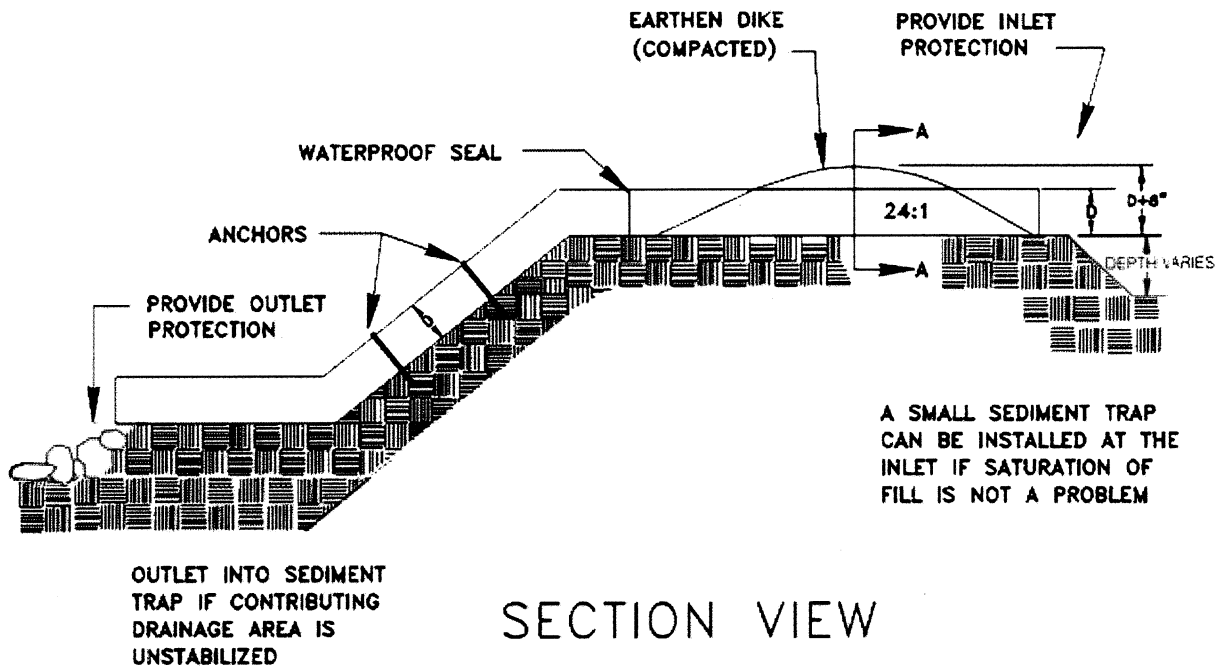
The diversion and berm must be kept clear to keep water flowing to the inlet. Correct any erosion of the berm and remove sediment deposits along the berm.

It cannot be overstated that maintenance is extremely important with this device. Occasionally this device will be left in place over the winter. A written maintenance schedule, using the above requirements, should be established and rigorously followed.

While this structure prevents erosion of the fill slope, failure to properly maintain this structure can cause **catastrophic** erosion over the dike and on the face of the fill slope.

FIGURE 3.16.1

# PIPE SLOPE DRAIN



FROM: VA. DSWC

## 3.17 - OUTLET PROTECTION

---

### ***Introduction***

A section of rock protection placed at the outlet end of the culverts and channels.

Pipe outlets are points of critical erosion potential. Stormwater exiting from a closed conveyance system generally reaches a velocity that exceeds the permissible or erosion resistant velocity of the receiving channel or overland area. To prevent scour at stormwater system outlets, a flow transition structure is needed which will absorb the initial impact of the flow and reduce the flow velocity to a level which will not erode the receiving channel or overland area.

Outlet protection consists of the construction of an erosion resistant section between a conduit outlet and a stable downstream channel. Erosion at an outlet is chiefly a function of soil type and the velocity of the conduit discharge. Therefore, in order to mitigate erosion, an adequate design must stabilize the area at the conduit outlet and reduce the outlet velocity to a velocity consistent with a stable condition in the downstream channel.

The design of riprap outlet protection applies to the immediate area or reach downstream of the pipe outlet and does not apply to continuous rock linings of channels or streams. For pipe outlets at the top of exit slopes or on slopes greater than 10%, the designer should assure that suitable safeguards are provided beyond the limits of the localized outlet protection to counter the highly erosive velocities caused by the re-concentration of flow beyond the initial riprap apron. Every effort should be made to protect the receiving channel from erosion down to a location in a natural waterway that can resist the forces of the water.

This standard applies to the planning, design, and construction of rock riprap and gabions for protection of downstream areas. It does not apply to rock lining of channels or streams. However, the riprap apron can be extended downstream for reasonable distances until stable conditions are reached even though this may exceed the length calculated for design velocity control.

### ***Conditions Where Practice Applies***

This practice applies where discharge velocities and energies at the outlets of culverts, conduits, or channels are sufficient to erode the next downstream reach. This applies to:

1. Culvert outlets of all types.
2. Pipe conduits from all sediment basins, dry storm water ponds, and permanent type ponds.
3. New channels constructed as outlets for culverts and conduits.



4. Velocity at outlet should be below 15 fps. If velocities exceed 15 fps a specifically designed outfall structure such as plunge pool or stilling basin should be used.

### ***Design Criteria***

The most commonly used device for outlet protection is a riprap-lined apron. Where practical, they are constructed at a zero grade or a minimum slope to slow the outlet velocity. The type and length of the riprap-lined apron is related to the outlet flow rate, the tailwater level and whether there is a defined channel downstream.

If the tailwater depth is less than half the outlet pipe rise, it shall be classified as a Minimum Tailwater Condition. If the tailwater depth is greater than or equal to half the outlet pipe rise, it shall be classified as a Maximum Tailwater Condition.

The design of rock outlet protection depends entirely on the location. Pipe outlets at the top of cuts or on slopes steeper than 10 percent, cannot be protected by rock aprons or riprap sections due to re-concentration of flows and high velocities encountered after the flow leaves the apron. Several counties in West Virginia have regulations and design procedures that may establish the dimensions, type and size of materials, and locations where outlet protection is required. Where these requirements exist, they shall be followed.

**Tailwater Depth**--The depth of tailwater immediately below the pipe outlet must be determined for the design capacity of the pipe. If the tailwater depth is less than half the diameter of the outlet pipe, and the receiving stream is wide enough to accept divergence of the flow, it shall be classified as a Minimum Tailwater Condition; see Figure 3.17.2 on page 3.17-11 as an example. If the tailwater depth is greater than half the pipe diameter and the receiving stream will continue to confine the flow, it shall be classified as a Maximum Tailwater Condition; see Figure 3.17.1 on page 3.17-10 as an example. Pipes which outlet onto flat areas with no defined channel may be assumed to have a Minimum Tailwater Condition; see Figure 3.17.2 on page 3.17-11 as an example.

**Apron Length**--The apron length shall be determined from the curves solely according to the tailwater conditions.

Minimum Tailwater – Use Figure 3.17.2 on page 3.17-11

Maximum Tailwater – Use Figure 3.17.1 on page 3.17-10

**Apron Width**--Where there is no defined channel immediately downstream of the apron, the width of the apron at the pipe outlet should be three times the maximum inside pipe span and the width at the end of the apron should be as follows:

For Minimum Tailwater Conditions:

Width at end of apron should equal the pipe diameter plus the calculated length of apron.

For Maximum Tailwater Conditions:

Width at end of apron should equal the diameter of the pipe plus 0.4 times the length of the outlet.

If the pipe discharges directly into a well defined channel, the apron shall extend across the channel bottom and up the channel banks to an elevation one foot above the maximum tailwater depth or to the top of the bank, whichever is less. The upstream end of the apron, adjacent to the pipe, shall have a width three (3) times the diameter of the outlet pipe, or conform to pipe end section if used. The bottom width of the apron should be at least equal to the bottom width of the existing channel.

**Bottom Grade--**The outlet protection apron shall be constructed with no slope along its length. There shall be no overfall at the end of the apron. The elevation of the downstream end of the apron shall be equal to the elevation of the receiving channel or adjacent ground.

**Alignment--**The outlet protection apron shall be located so that there are no bends in the horizontal alignment.

**Materials--**The outlet protection may be done using rock riprap, grouted riprap, or gabions. Riprap shall be composed of a well-graded mixture of stone size so that 50 percent of the pieces, by weight, shall be larger than the  $d_{50}$  size determined by using the charts. A well-graded mixture, as used herein, is defined as a mixture composed primarily of larger stone sizes, but with a sufficient mixture of other sizes to fill the smaller voids between the stones. The diameter of the largest stone size in such a mixture shall be 1.5 times the  $d_{50}$  size.

**Thickness--**The minimum thickness of the riprap layer shall be 1.5 times the maximum stone diameter. The following chart lists some examples:

<b><math>D_{50}</math> (inches)</b>	<b><math>d_{max}</math> (inches)</b>	<b>blanket thickness (inches)</b>
4	6	9
6	9	14
9	14	21
12	18	27
15	22	33
18	27	41
21	32	48
24	36	54

**Stone Quality--**Stone for riprap shall consist of fieldstone or rough unhewn quarry stone. The stone shall be hard, angular and of a quality that will not disintegrate on exposure to water or weathering. The specific gravity of the individual stones shall be at least 2.5. Recycled concrete equivalent may be used provided it has a density of at least 150

pounds per cubic foot, and does not have any exposed steel or reinforcing bars.

**Separation Fabric**--In all cases, filter fabric shall be placed between the riprap and the underlying soil to protect soil movement into, through, and underneath the riprap. The material must meet or exceed these requirements: The plastic filter cloth can be woven or non-woven monofilament yarns, and shall meet these base requirements: thickness 20-60 mils, grab strength 90-120 lbs; and shall conform to ASTM D-1777 and ASTM D- 1682.

**Gabions**--Gabions shall be made of hexagonal triple twist mesh with heavily galvanized steel wire. The maximum linear dimension of the mesh opening shall not exceed 4 ½ inches and the area of the mesh opening shall not exceed 10 square inches.

Gabions shall be fabricated in such a manner that the sides, ends, and lid can be assembled at the construction site into a rectangular basket of the specified sizes. Gabions shall be of single unit construction and shall be installed according to manufacturer's recommendations.

The area on which the gabion is to be installed shall be graded as shown on the drawings. Foundation conditions shall be the same as for placing rock riprap, and filter cloth shall be placed under all gabions. Where necessary, key, or tie, the structure into the bank to prevent undermining of the main gabion structure.

For submittal to DEP, include the following in the SWPPP:

- Location where the practice will be installed.
- Dimensions of the practice.
- Plan view, profile and cross section of each channel reach between the storm drain outlet under consideration and the existing publicly maintained system or the natural stream channel receiving the discharge flow.
- Rock size.
- Rock thickness.
- Fabric specifications.

**Table 3.17.1  
PERMISSIBLE VELOCITIES FOR GRASS-LINED CHANNELS**

Channel Slope	Lining	Velocity* (ft./sec.)
0 - 0.5%	Bermudagrass	6
	Reed canarygrass Tall fescue Kentucky bluegrass	5
	Grass-legume mixture	4
	Red fescue Redtop Sericea lespedeza Annual lespedeza Small grains Temporary vegetation	2.5
	Bermudagrass	5
5 - 10%	Reed canarygrass Tall fescue Kentucky bluegrass	4
	Grass-legume mixture	3
	Bermudagrass	4
	Reed canarygrass Tall fescue Kentucky bluegrass	3
* For highly erodible soils, decrease permissible velocities by 25%.		

Source: Soil and Water Conservation Engineering, Schwab, et. al. and American Society of Civil Engineers

**Table 3.17.2**  
**PERMISSIBLE VELOCITIES FOR EARTH LININGS**

Soil Types	Permissible Velocities (ft./sec.)
Fine Sand (noncolloidal)	2.5
Sandy Loam (noncolloidal)	2.5
Silt Loam (noncolloidal)	3.0
Ordinary Firm Loam	3.5
Fine Gravel	5.0
Stiff Clay (very colloidal)	5.0
Graded, Loam to Cobbles (noncolloidal)	5.0
Graded, Silt to Cobbles (colloidal)	5.5
Alluvial Silts (noncolloidal)	5.5
Alluvial Silts (colloidal)	5.0
Coarse Gravel (noncolloidal)	6.0
Cobbles and Shingles	5.5
Shales and Hard Plans	6.0

Source: Soil and Water Conservation Engineering, Schwab, et. al. and American Society of Civil Engineers

***Construction  
Specifications***

1. The subgrade for the filter, riprap, or gabion shall be prepared to the required lines and grades. Any fill required in the subgrade shall be compacted to a density of approximately that of the surrounding undisturbed material.
2. The rock or gravel shall conform to the specified grading limits when installed respectively in the riprap or filter.

3. Filter cloth shall be protected from punching, cutting, or tearing. Any damage other than an occasional small hole shall be repaired by placing another piece of cloth over the damaged part or by completely replacing the cloth. All overlaps, whether for repairs or for joining two pieces of cloth shall be a minimum of one foot.

4. Stone for the riprap or gabion outlets may be placed by equipment. Both shall be constructed to the full course thickness in one operation and in such a manner as to avoid displacement of underlying materials. The stone for riprap or gabion outlets shall be delivered and placed in a manner that will ensure that it is reasonably homogenous with the smaller stones and spalls filling the voids between the larger stones. Riprap shall be placed in a manner to prevent damage to the filter blanket or filter cloth. Hand placement will be required to the extent necessary to prevent damage to the permanent works.

### ***Maintenance***

Once a riprap outlet has been installed, the maintenance needs are very low. It should be inspected after high flows for evidence of scour beneath the riprap or for dislodged stones. If a significant number of stones have been dislodged it will be necessary to recalculate stone size and replace the existing stone with properly sized stone. Any repairs must be made immediately.

### ***Design Procedure***

1. Investigate the downstream channel to assure that non-erosive velocities can be maintained.
2. Determine the tailwater condition at the outlet to establish which curve to use.
3. Enter the appropriate chart with the design discharge to determine the riprap size and apron length required. It is noted that references to pipe diameters in the charts are based on full flow. For other than full pipe flow, the parameters of depth of flow and velocity must be used to adjust the design discharges.
4. Calculate apron width at the downstream end if a flare section is to be employed.

### **Examples**

**Example 1:** Pipe Flow (full) with discharge to unconfined section.

Given: A circular conduit flowing full.

$Q = 280$  cfs, diameter = 66 in., tailwater (surface) is 2 ft. above pipe invert (Minimum Tailwater Condition).

Find: Read  $d_{50} = 1.2$  ft and apron length ( $L_a$ ) = 38 ft.

$$\text{Apron width} = \text{diam.} + L_a = 5.5' + 38' = 43.5 \text{ ft.}$$

Use:  $d_{50} = 15''$ ,  $d_{\max} = 22''$ , blanket thickness = 32''

**Example 2:** Box Flow (partial) with high tailwater

Given: A box conduit discharging under partial flow conditions. A concrete box 5.5 ft. x 10 ft. flowing 5.0 ft. deep,

$Q = 600$  cfs and tailwater surface is 5 ft. above invert (max. tailwater condition).

Since this is not full pipe and does not directly fit the nomograph assumptions substitute depth as the diameter, to find a discharge equal to full pipe flow for that diameter, in this case 60 inches.

$$\text{Since, } Q = AV \text{ and } A = \frac{\pi D^2}{4}$$

First, compute velocity:

$$V = (Q/A) = (600/(5)(10)) = 12 \text{ fps}$$

Then substituting:

$$Q = \frac{\pi D^2}{4} \times V = \frac{3.14 (5 \text{ ft})^2}{4} \times 12 \text{ fps} = 236 \text{ cfs}$$

At the intersection of the curve,  $d = 60$  in. and  $Q = 236$  cfs, read  $d_{50} = 0.4$  ft.

Then reading the  $d = 60$  in. curve, read apron length ( $L_a$ ) = 40 ft.

Apron width,  $W = \text{conduit width} + (6.4)(L_a) = 10 + (0.4)(40) = 26$  ft.

**Example 3:** Open Channel Flow with Discharge to Unconfined Section

Given: A trapezoidal concrete channel 5 ft. wide with 2:1 side slopes is flowing 2 ft. deep,  $Q = 180$  cfs (velocity = 10 fps) and the tailwater surface downstream is 0.8 ft. (minimum tailwater condition).

Find: Using similar principles as Example 2, compute equivalent discharge for a 2 foot, using depth as a diameter, circular pipe flowing full at 10 feet per second.

Velocity:

$$Q = \frac{\pi (2\text{ft})^2}{4} \times 10 \text{ fps} = 31.4 \text{ cfs}$$

At intersection of the curve,  $d = 24$  in. and  $Q = 32$  cfs, read  $d_{50} = 0.6$  ft.

Then reading the  $d = 24$  in. curve, read apron length ( $L_a$ ) = 20 ft.

Apron width,  $W =$  bottom width of channel +  $L_a = 5 + 20 = 25$  ft.

**Example 4:** Pipe flow (partial) with discharge to a confined section

Given: A 48 in. pipe is discharging with a depth of 3 ft.  $Q = 100$  cfs, and discharge velocity of 10 fps (established from partial flow analysis) to a confined trapezoidal channel with a 2 ft. bottom, 2:1 side slopes,  $n = .04$ , and grade of 0.6%.

Calculation of the downstream channel (by Manning's Equation) indicates a normal depth of 3.1 ft. and normal velocity of 3.9 fps.

Since the receiving channel is confined, the Maximum Tailwater Condition controls.

Find: discharge using previous principles:

$$Q = \frac{\pi (3\text{ft})^2}{4} \times 10 \text{ fps} = 71 \text{ cfs}$$

At the intersection of  $d = 36$  in. and  $Q = 71$  cfs, read  $d_{50} = 0.3$  ft.

Reading the  $d = 36$ " curve, read apron length ( $L_a$ ) = 30 ft.

Since the maximum flow depth in this reach is 3.1 ft. that is the minimum depth of riprap to be maintained for the entire length of the apron.



FIGURE 3.17.1

DESIGN OF OUTLET PROTECTION FROM A ROUND PIPE FLOWING FULL  
 MAXIMUM TAILWATER CONDITION ( $T_w \geq 0.5$  DIAMETER) (USDA-NRCS)

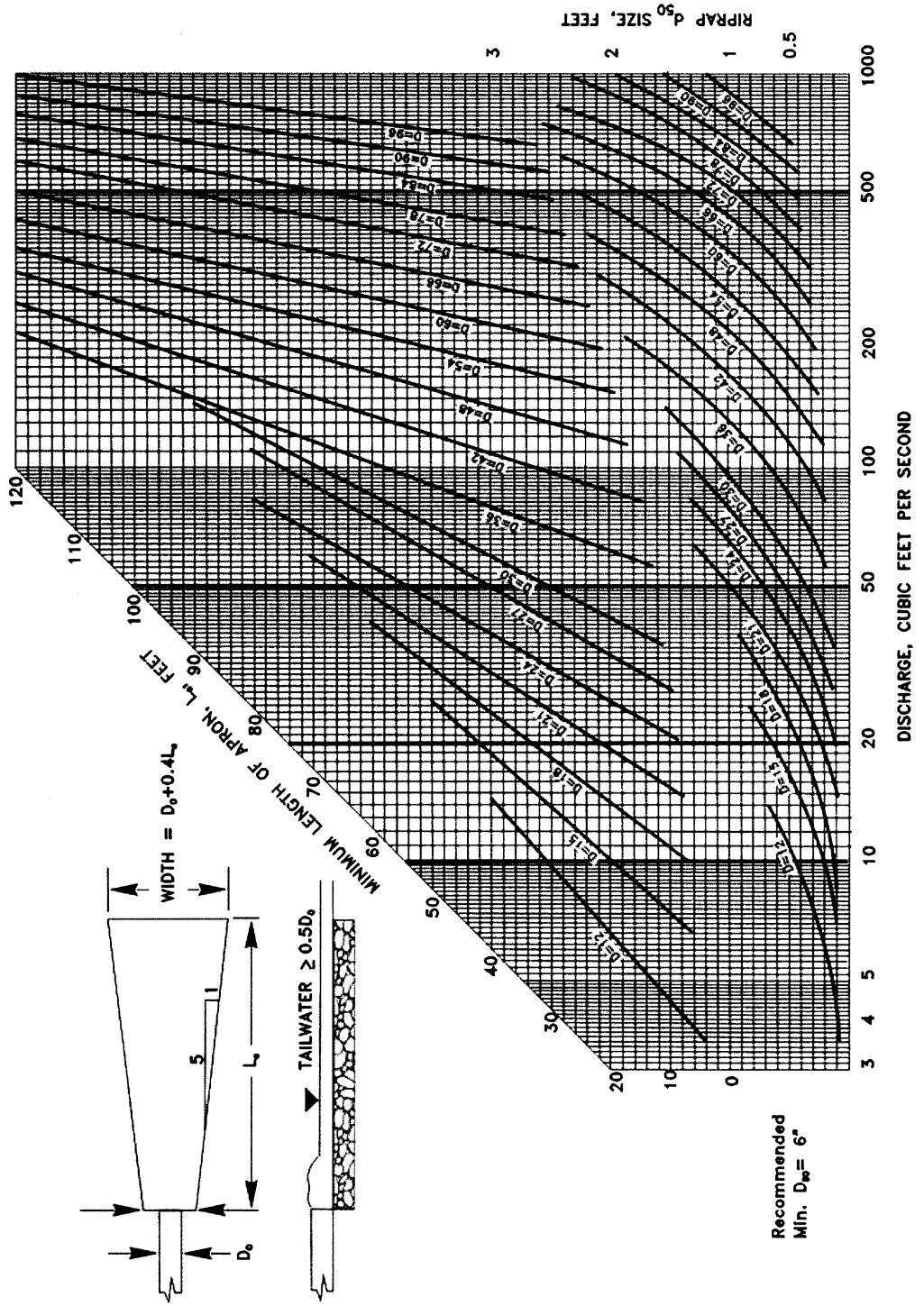


FIGURE 3.17.2

DESIGN OF OUTLET PROTECTION FROM A ROUND PIPE FLOWING FULL  
 MINIMUM TAILWATER CONDITION ( $T_w < 0.5$  DIAMETER) (USDA-NRCS)

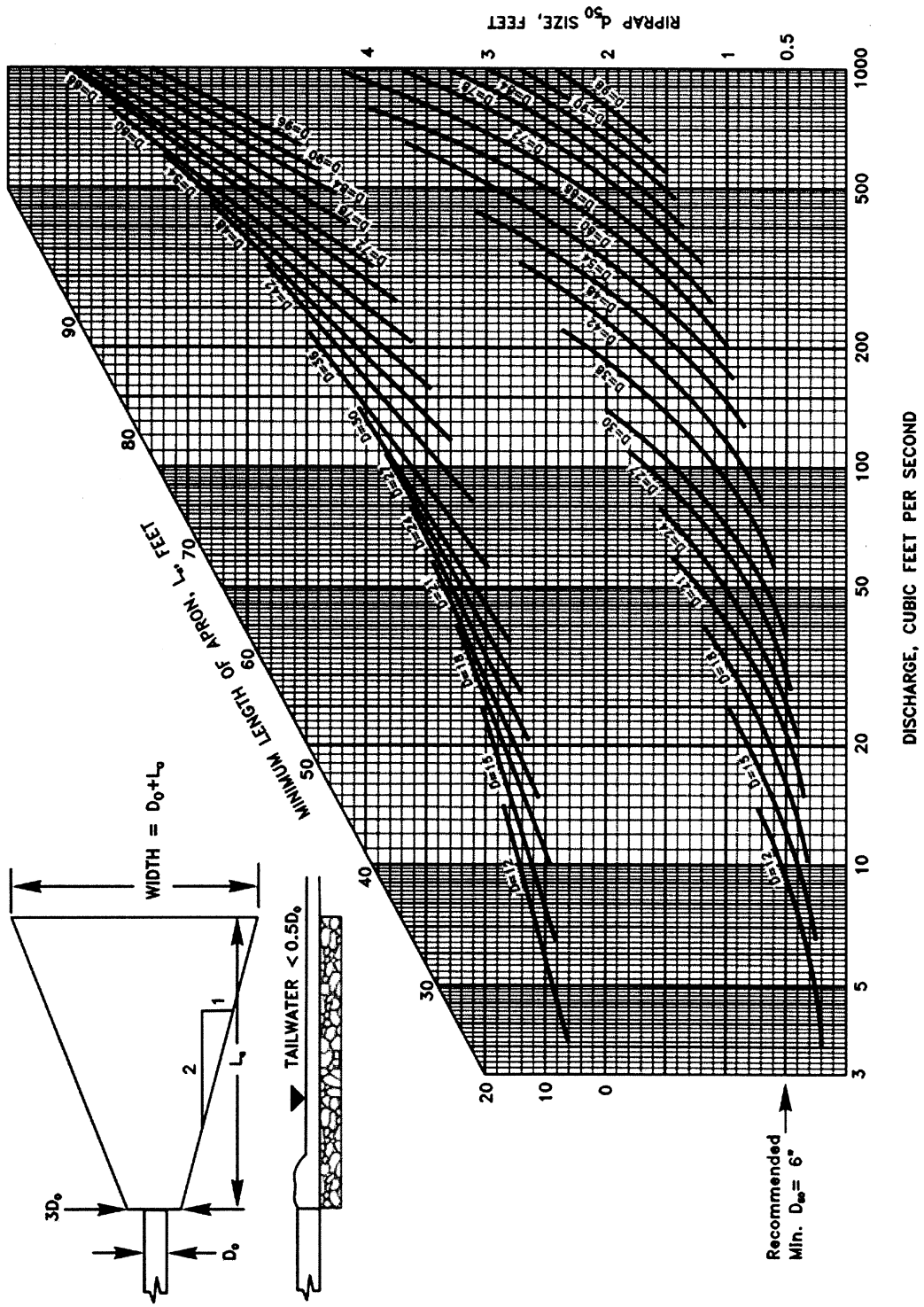
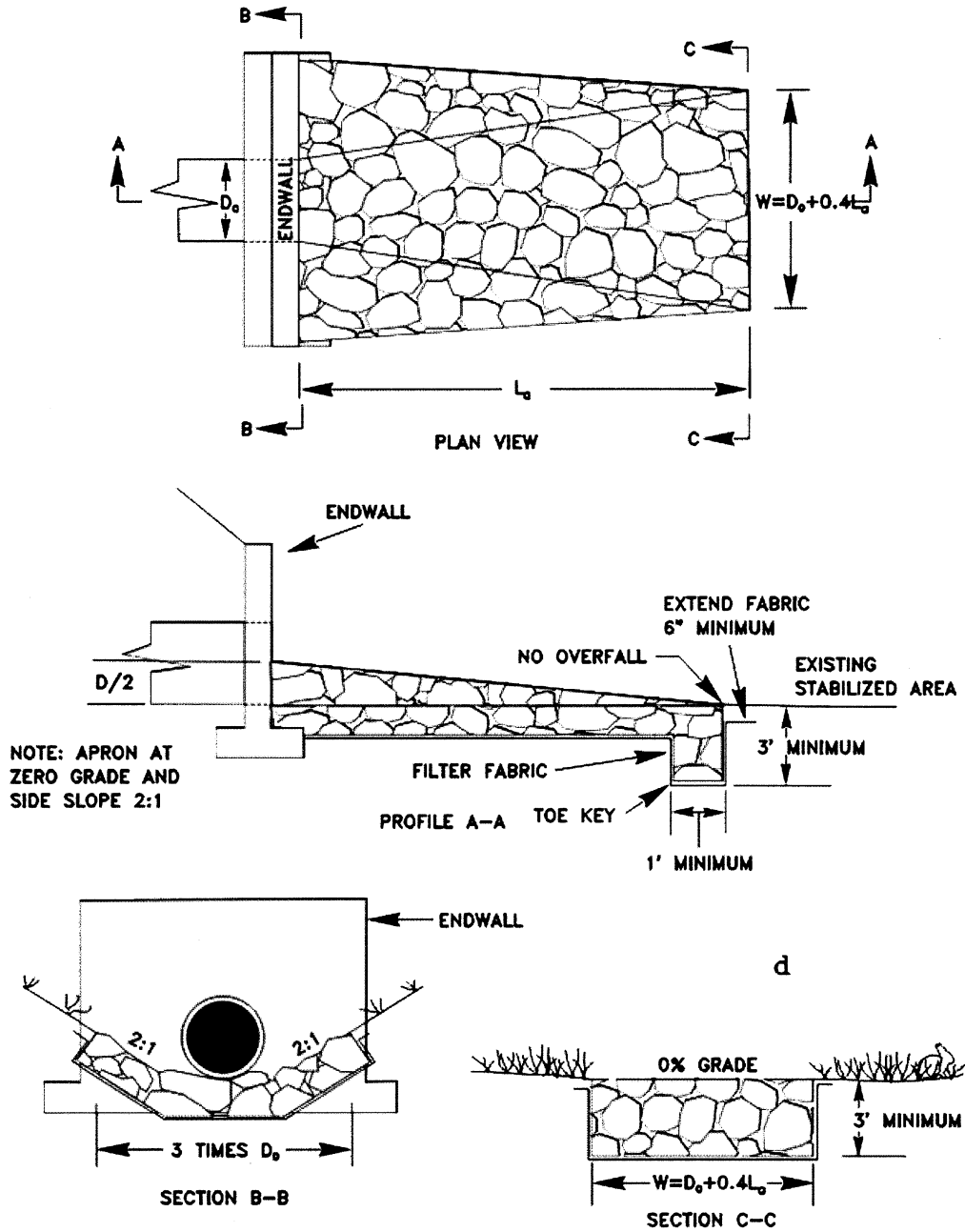


FIGURE 3.17.3

# OUTLET PROTECTION

DISCHARGE TO UNCONFINED SECTION  
(MINIMUM TAILWATER)

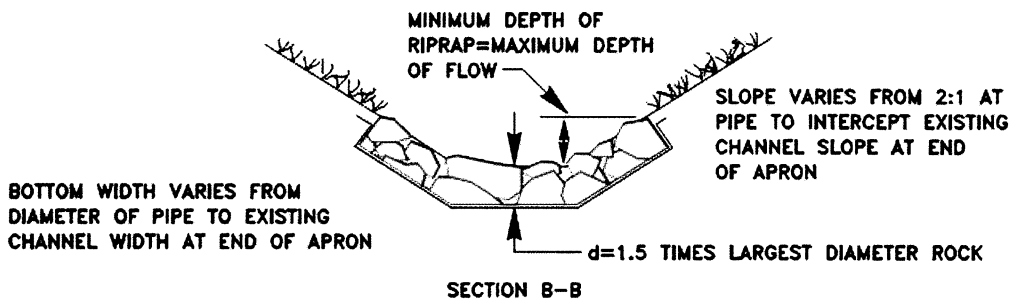
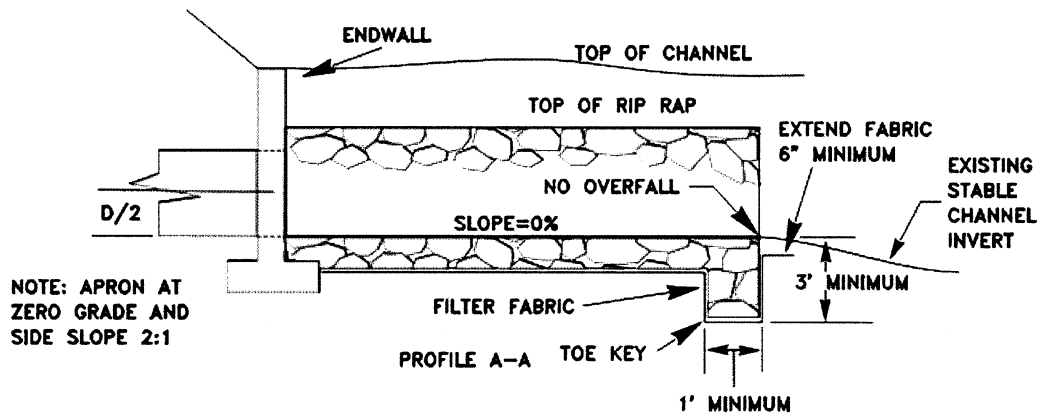
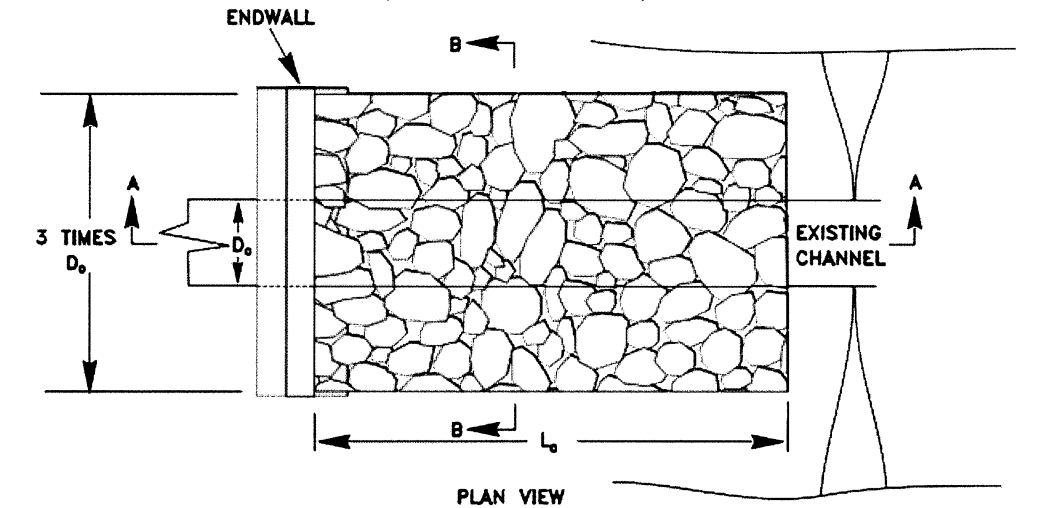


FROM NEW YORK STANDARDS AND SPECIFICATIONS  
FOR EROSION AND SEDIMENT CONTROL

FIGURE 3.17.4

# OUTLET PROTECTION

DISCHARGE TO CONFINED CHANNEL  
(MINIMUM TAILWATER)

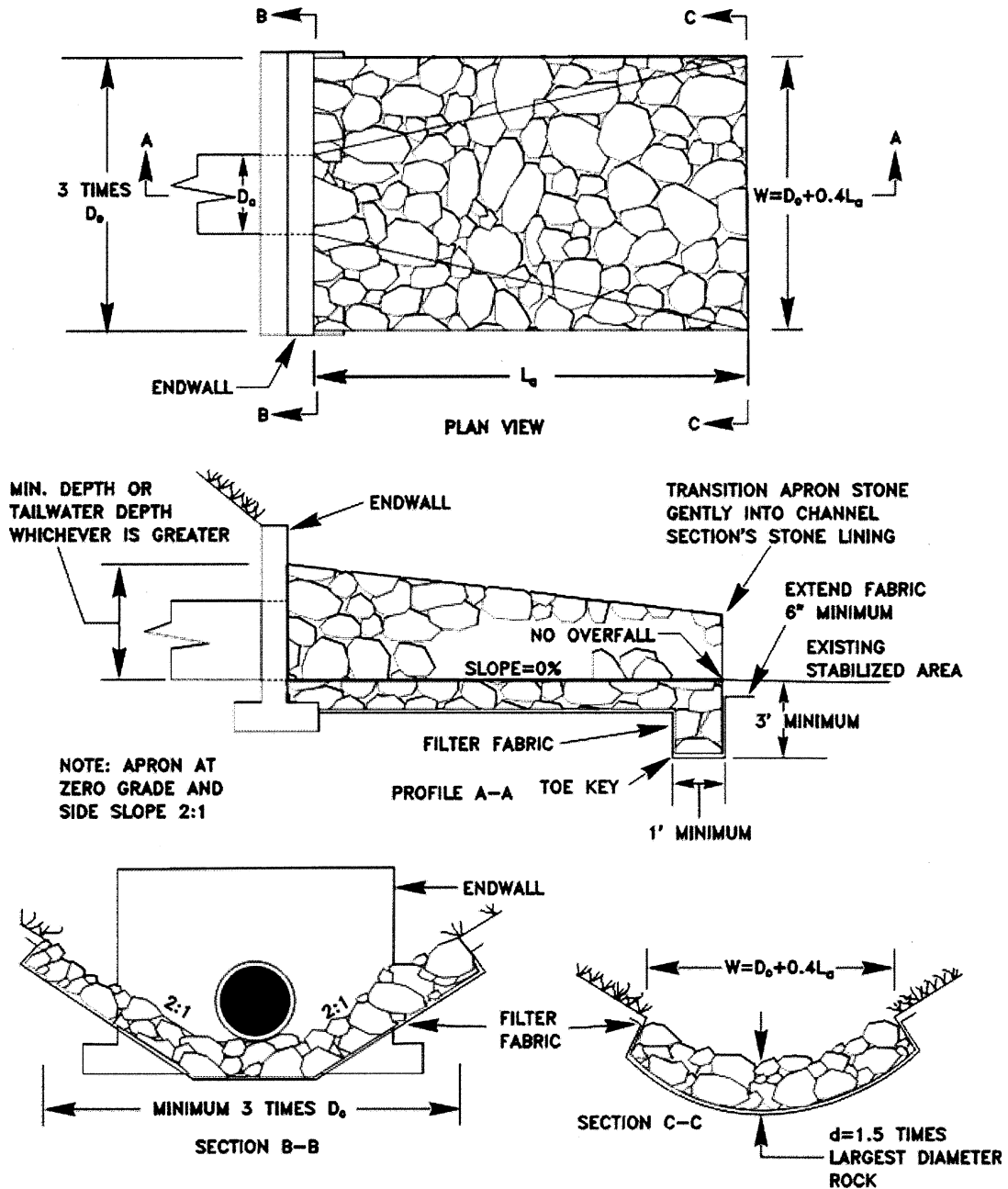


FROM NEW YORK STANDARDS AND SPECIFICATIONS  
FOR EROSION AND SEDIMENT CONTROL

FIGURE 3.17.5

# OUTLET PROTECTION

DISCHARGE TO SEMI-CONFINED SECTION  
(MAXIMUM TAILWATER)



FROM NEW YORK STANDARDS AND SPECIFICATIONS  
FOR EROSION AND SEDIMENT CONTROL

# 3.18 - RIGHT OF WAY DIVERSION

## **Introduction**

Right-of-way Interceptor Diversion is a ridge of dirt or a ridge and a channel combination constructed on an angle across a utility right-of-way used to shorten flow paths and flatten slopes to reduce the erosive force of water or to direct water away from critical resources. It can be both a temporary and permanent structure.

## **Conditions Where Practice Applies**

This practice is applicable on all utility construction that occurs on sloping ground. In fact, it is probably the most common sediment control practice used in pipeline construction.

## **Design Criteria**

No formal design is required. The spacing between diversions shall not exceed the requirements below.

## **Construction Specifications**

1. Drainage Area: The maximum allowable drainage area is 1 acre.
2. Spacing: Use the following table when choosing the placement of the diversion. Use this chart for both permanent and temporary diversions.

Percent Slope	Spacing in Feet
[5	300
10	175
15	125
20	100
<25	75

\* It is difficult to install diversions on slopes steeper than 35%, the Division of Water and Waste Management will allow greater distances between diversions on extreme slopes.

3. Height: The minimum allowable height measured from the upslope side of the dike is 12 inches.
4. Grade: The channel behind the dike shall have a positive grade to a stabilized outlet. The diversion must be angled at least 3 or 4 degrees relative to the fall line of the slope and should not exceed 8 degrees.
5. Outlet: Each diversion should exit onto stabilized ground. It should never exit onto the right-of-way where it can run down to the next diversion.

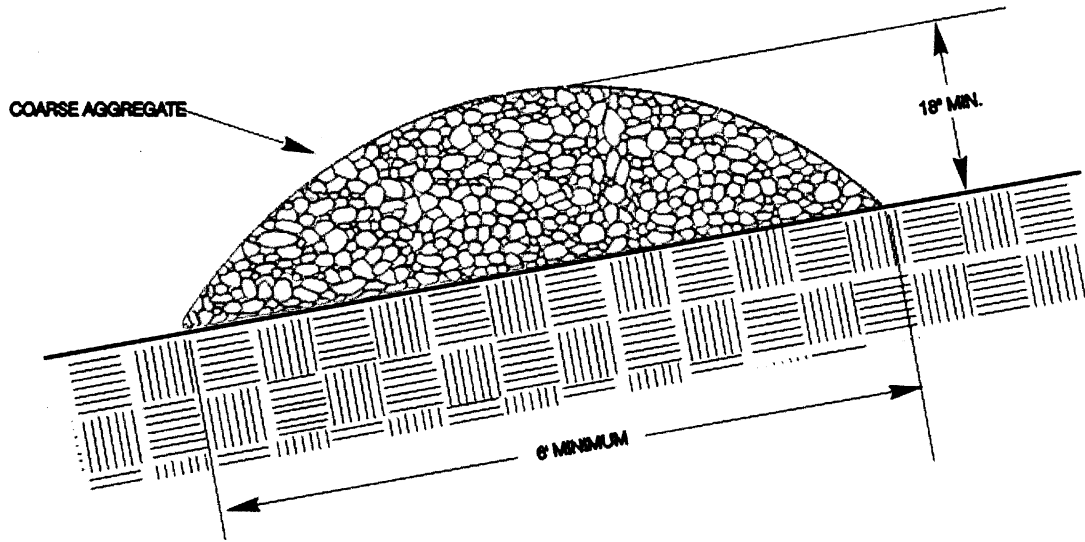
6. Temporary diversion dikes must be installed as a first step after clearing and grubbing, or grading on a replacement project.
7. The diversions must be in place and functional at the end of each workday, especially when work will be discontinued for several days as on a weekend. Keep an eye on the weather forecast.
8. The berm shall be compacted by running a tracked piece of equipment across the length of the berm at least once.
9. Where the required spacing cannot be met due to excessive slope, a diversion will be installed at the nearest convenient point above and below the step section.

***Maintenance***

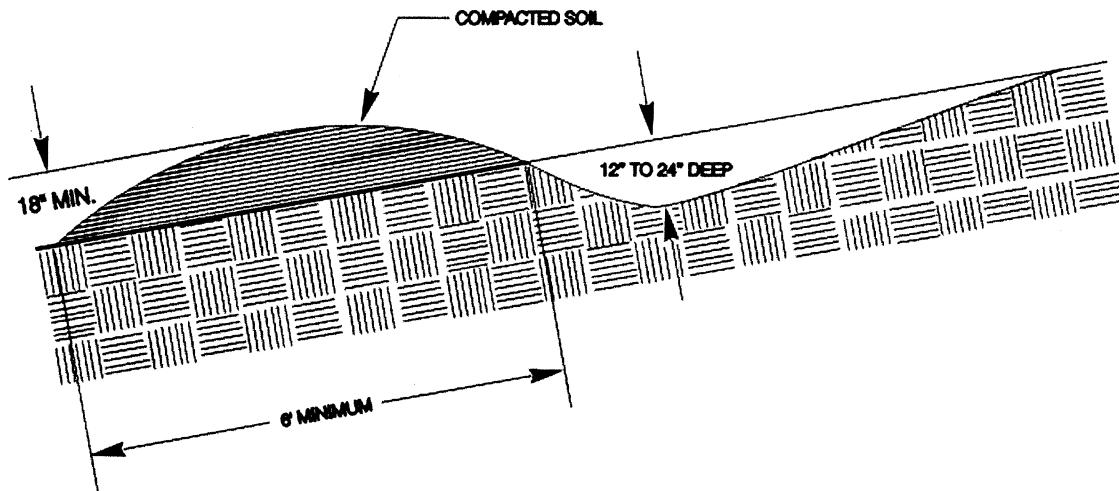
The measure shall be inspected after every rain event of .5 inch or more and repairs made as necessary. Once every week, whether a storm event has occurred or not, the measure shall be inspected and repairs made if needed. In areas where construction is actively occurring, diversions should be inspected daily, and damage caused by construction traffic or other activity repaired before the end of each working day.

FIGURE 3.18.1

## *RIGHT-OF-WAY DIVERSIONS*



*TYPICAL GRAVEL STRUCTURE*



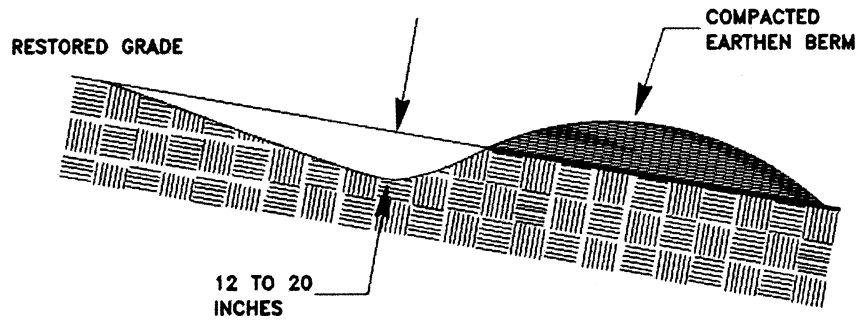
*TYPICAL EARTHEN STRUCTURE*

Source: Va. SWCC

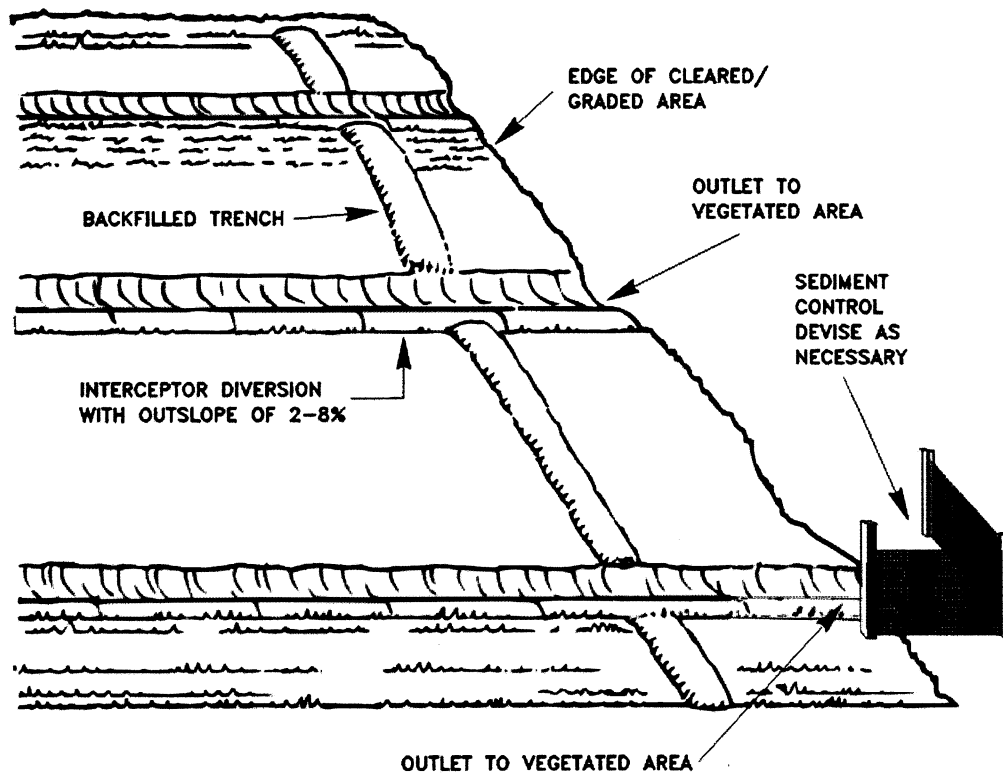


FIGURE 3.18.2

# RIGHT-OF-WAY DIVERSION



FINAL DIVERSION CROSS-SECTION



## 3.19 - LEVEL LIP SPREADER

---

### ***Introduction***

An outlet for dikes and diversions consisting of an excavated depression constructed at zero grade across a slope used to convert concentrated runoff to sheet flow and release it uniformly onto areas stabilized by existing vegetation.

### ***Conditions Where Practice Applies***

Where there is a need to divert **small** amounts of clean stormwater away from disturbed areas to avoid overwhelming erosion control measures; where sediment-free storm runoff can be released in sheet flow down a well-vegetated, stabilized slope without causing erosion.

This practice applies only in those situations where the spreader can be constructed on undisturbed soil and the area below the level lip is uniform with a slope of 10% or less and is stabilized by natural vegetation or other non-erosive materials. The runoff water should not be allowed to re-concentrate after release unless it occurs during interception by another measure (such as a permanent pond or detention basin) located below the level spreader.

Caution should be used in using this device. Sheet flow easily changes to concentrated flow and consequently can cause downslope erosion if the specifications in this section are not followed closely.

### ***Planning Considerations***

The Temporary Diversion Dike, permanent stormwater conveyances and other waterways call for a stable outlet for concentrated stormwater flows. The level spreader is a relatively low-cost structure to release small volumes of concentrated flow but only when site conditions are suitable.

The outlet area must be uniform and well vegetated with slopes 10% or less. Particular care must be taken to construct the outlet lip completely level in a stable, undisturbed soil. Any depressions in the lip will concentrate the flow, resulting in erosion. Under higher design flow conditions, a rigid outlet lip design should be used to create the desired sheet flow conditions. Runoff water containing high sediment loads must be treated in a sediment-trapping device before being released to a level spreader.

This practice is difficult to install correctly. It is critical to install the lip perfectly level; failure to do so will cause a concentration of flows and erosion.

### ***Design Criteria***

No formal design is required except in the case of a permanent application the spreader should be designed to handle the peak discharge expected from a 10-year/24-hour storm.

**Construction  
Specifications**

1. Level spreaders must be constructed on undisturbed soil (not fill material).
2. The entrance to the spreader must be shaped in such a manner as to insure that runoff enters directly onto the 0% channel.
3. Construct a 20-ft. transition section from the diversion channel to blend smoothly to the width and depth of the spreader.
4. The level lip shall be constructed at 0% grade to insure uniform spreading of stormwater runoff.
5. Protective covering (blankets) for vegetated lip should be a minimum of 4 feet wide extending 6 inches over the lip and buried 6 inches deep in a vertical trench on the lower edge. The upper edge should butt against smoothly cut sod and be securely held in place with closely spaced heavy-duty wire staples.
6. Rigid level lip should be entrenched at least 2 inches below existing ground and securely anchored to prevent displacement. An apron of AASHTO #1, #2 or #3 Coarse Aggregate should be placed to top of level lip and extended downslope at least 3 feet. Place filter fabric under stone and use galvanized wire mesh to hold stone securely in place.
7. The released runoff must outlet onto undisturbed stabilized areas with slope not exceeding 10%. Slope must be sufficiently smooth to preserve sheet flow and prevent flow from concentrating.
8. The level spreader should be sized to transfer 0.25 cfs per linear foot of spreader for the peak discharge from a ten-year/24-hour storm.
9. Immediately after its construction, appropriately seed and mulch the entire disturbed area of the spreader.

**Maintenance**

The measure shall be inspected after every rainfall of .5" or more and repairs made, if required. After construction and until fully revegetated, the level spreaders need to be carefully inspected for any signs of channelization and immediately repaired.

Level spreader lip must remain at 0% slope to allow proper function of measure.

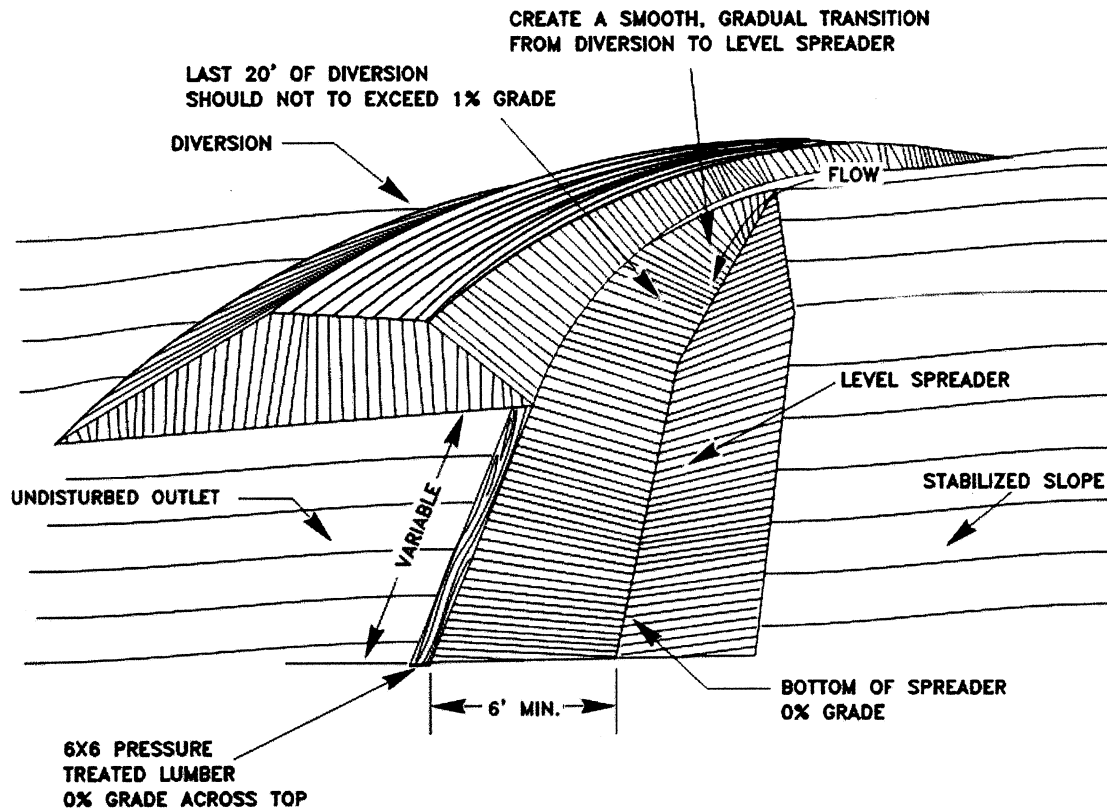
The contractor should avoid the placement of any material on and prevent construction traffic across the structure.

If the measure is damaged by construction traffic, it shall be repaired immediately.

Repeated failure of the structure will require the developer to replace the Level Lip Spreader with a properly designed stormwater conveyance channel from the diversion to the nearest natural waterway or stormwater basin.

FIGURE 3.19.1

## LEVEL SPREADER



## PERSPECTIVE VIEW

NOTE: ALL TEMPORARY BERMS, SWALES AND LEVEL SPREADER DITCH MUST RECEIVE TEMPORARY SEEDING AND MULCHING AFTER INSTALLATION

SOURCE: ADAPTED FROM N.C. E&S Control Planning and Design Manual and VA DESCI

## 3.20 - SURFACE WATER CONTROL

---

### ***Introduction***

One of the most important (but often overlooked) techniques of sediment and erosion control is the proactive management of surface water runoff. By anticipating where runoff will occur and directing water to go where it will do the least damage, erosion can be, in some cases, almost eliminated. By directing runoff to stabilized conveyances such as pipe slope drains, riprap channels and rock underdrains, slopes, fills and haul roads can be protected from excessive erosion. Work areas dry quicker after rainfall events, and the contractor saves time and money by not having to regrade areas damaged by erosion. The use of some of these techniques can reduce the size requirements of sediment basins and traps, but only if approved by DWWM during the SWPPP review.

Except for areas that can be treated by silt fence or super silt fence, all runoff from disturbed areas must be intercepted and conveyed to a sediment pond or trap.

At a minimum, temporary storm water conveyances should have the capacity to pass the peak flow from 2-year/24-hour storm. Significant sources of clean upslope surface water that drain onto disturbed areas shall be intercepted and conveyed to a stabilized discharge point where the water will not drain back onto the disturbed area. Upslope diversions must discharge where there can be no damage to adjacent land. Surface water controls shall be installed concurrently with rough grading.

### ***Conditions Where Practice Applies:***

The purpose of surface water control is to collect and convey surface water so that erosion is minimized and contaminated runoff from disturbed areas is treated by a sediment pond or trap. Upslope diversions reduce the volume of runoff to the disturbed area on a construction project and allows for the design of a smaller sediment trapping structure.

Surface water control consists of several practices alone or in combination:

1. Interception of runoff above cut slopes to a stable outlet.
2. Conveyance of the contaminated runoff to a sediment pond or trap.
3. Internal control of runoff across roadways and fills.
4. Control runoff from fill areas via pipe slope drains, rip-rap channels, or rock wick underdrains.
5. Control of water on the cut slope.
6. Conveyance of the treated runoff from the trap or basin to a stable waterway.

However, “controlling runoff” is not easily defined and there will be numerous conditions during the construction phase that this specification

will not cover. Contractors are encouraged to incorporate these techniques and guidelines into their typical construction methods. However, the most important concept is to plan construction as if it will rain, not that it won't rain.

### ***Timing of Installation***

Surface water controls such as upslope clean water diversions and dirty water diversions to sediment basins and traps are to be constructed during the initial clearing and grubbing of an area and must be functional prior to the start of major grading operations.

The rock underdrain must be started prior to initial fill placement.

The rest of the water runoff control practices are installed as needed as grading operations proceed. Diversion berms at the top of slopes and either pipe slope drains or rip rap channels are installed as the fill progresses.

When using the riprap channel conveyance the installation of the channel must coincide with filling operations. There should be little or no delay in installing the channel and connecting it to the top of the fill.

Positive drainage and/or diversions must be maintained at all times to direct runoff towards the pipe slope drain, rock underdrain or rip rap channel.

Individual BMPs used in this practice:

1. Interceptor dikes/swales,
2. Rock wick or underdrain.
3. Rip rap ditches
4. Pipe slope drains,
5. Outlet protection

See the following drawings for schematic representation on the use of these measures.

### ***Materials***

The Surface Water Control Best Management Practice utilizes a number of other individual Best Management Practices from this Manual. Except for the rock underdrain, the material requirements can be found under each individual practice.

The Rock Underdrain is constructed like a huge French Drain. Rock for the underdrain or wick shall consist of durable Shot Rock, Select Embankment or large Riprap with little or no fine material. The rock core must be wrapped in a suitable filter fabric geotextile to prevent soil fines from clogging the voids.

### ***Maintenance***

Maintenance requirements are listed in each separate practice. But in general, this practice is to be inspected once a week or immediately after each 0.5-inch or greater rain event.

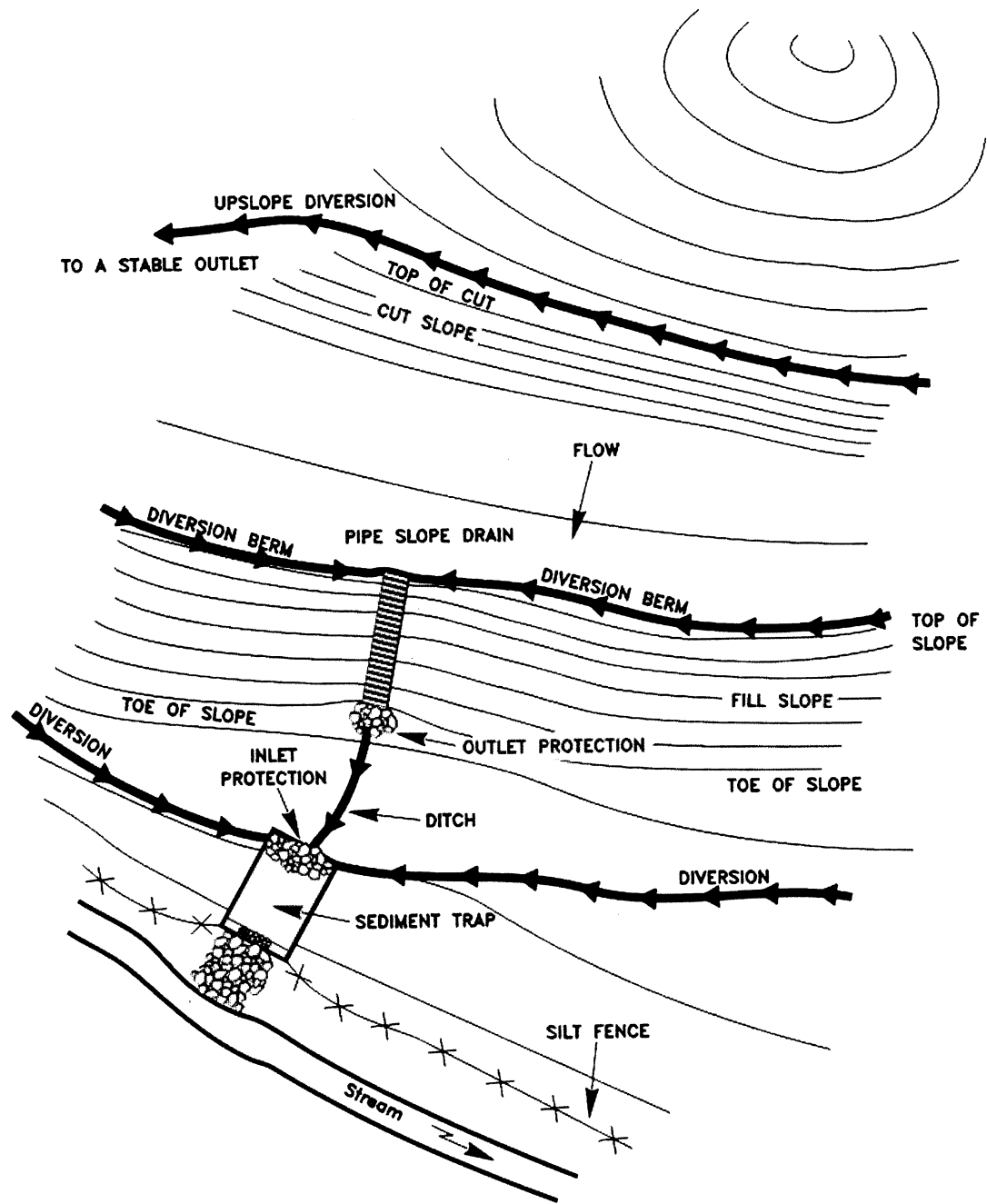
Positive drainage towards the conveyance(s) must be maintained at all times.

***NOTE***

**The use of the Fill with Rock Underdrain may not be appropriate in all cases and should be reviewed by a geotechnical engineer.**

FIGURE 3.20.1

# SURFACE WATER CONTROL



From: King County, Washington ESC Manual



FIGURE 3.20.2

# SURFACE WATER CONTROL

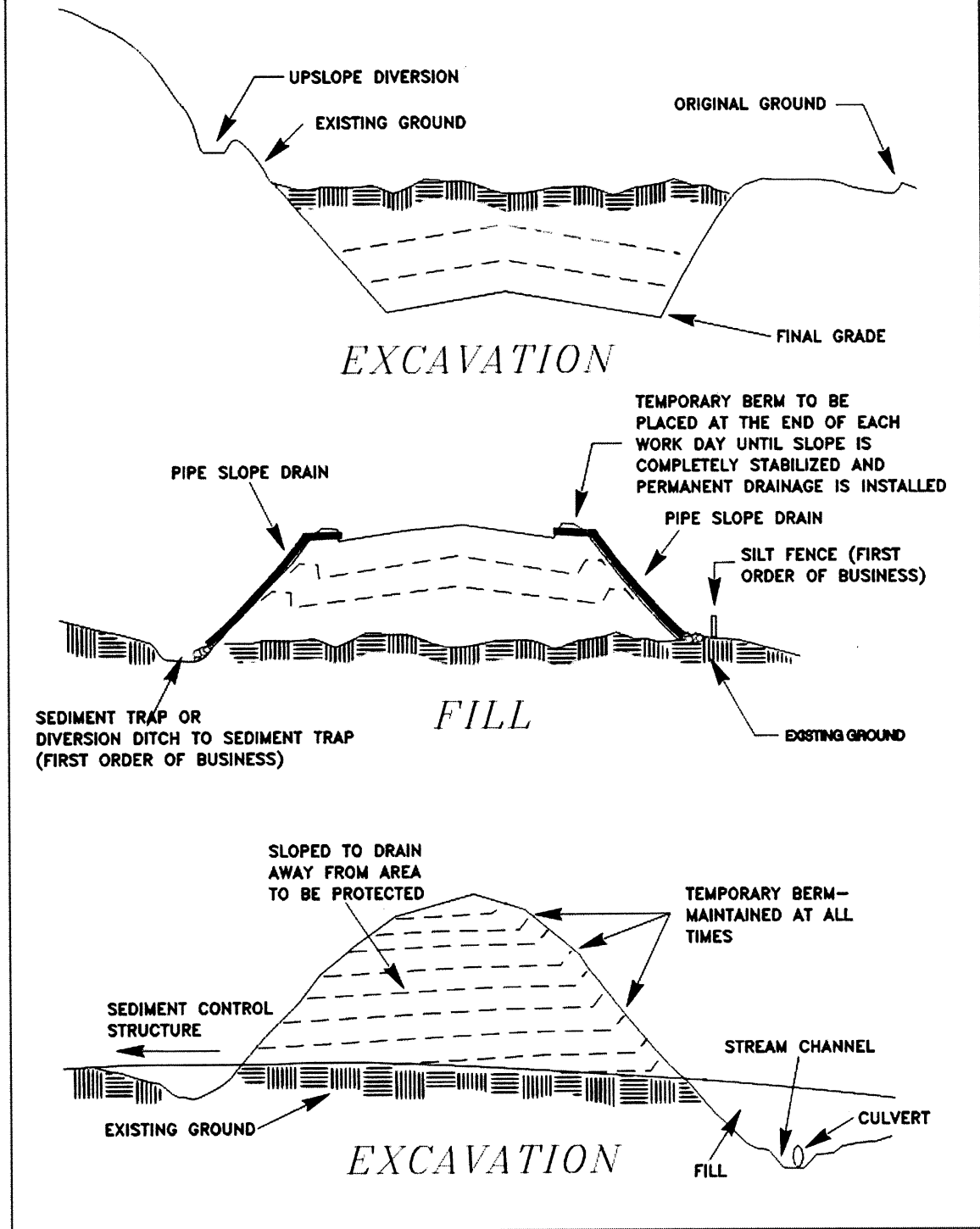


FIGURE 3.20.3

# *SIDE HILL CUT AND FILL*

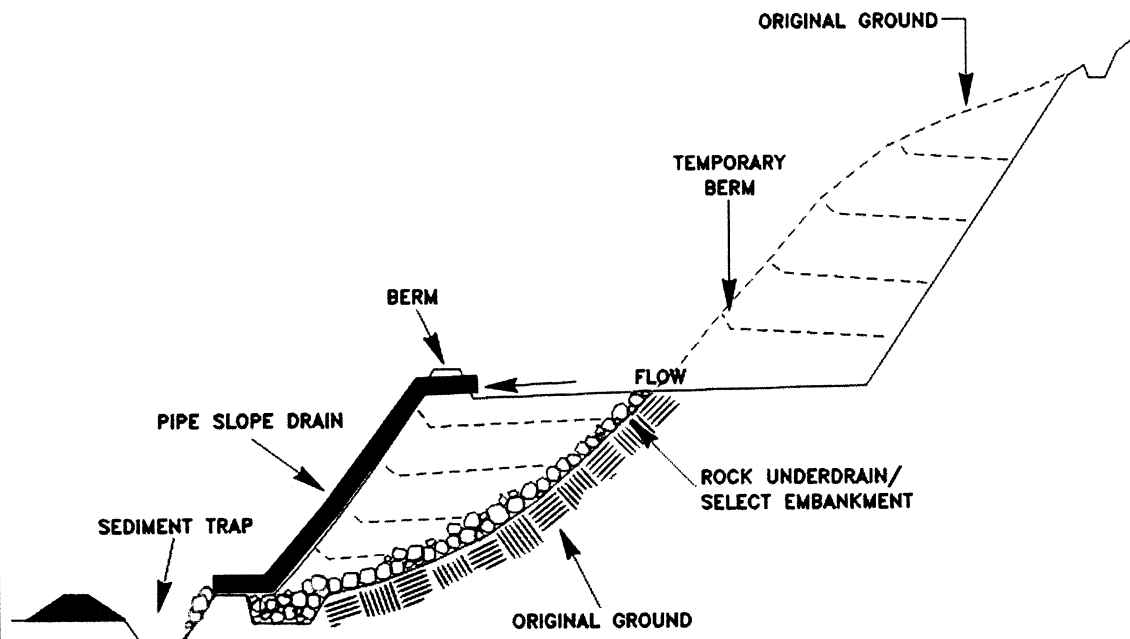


FIGURE 3.20.4

# FILL WITH ROCK UNDER DRAIN

## SECTION A-A

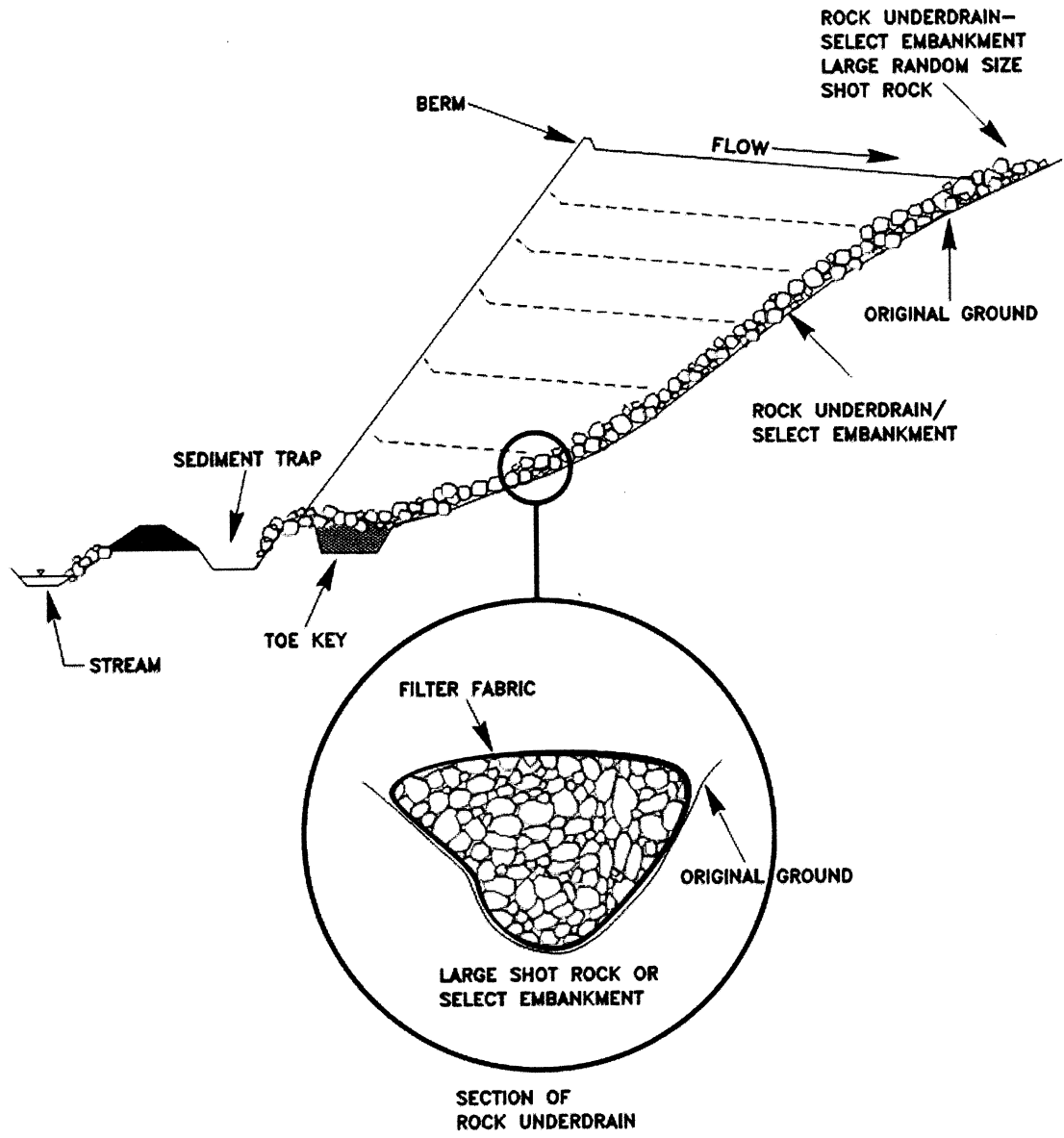


FIGURE 3.20.5

# FILL WITH ROCK UNDER DRAIN

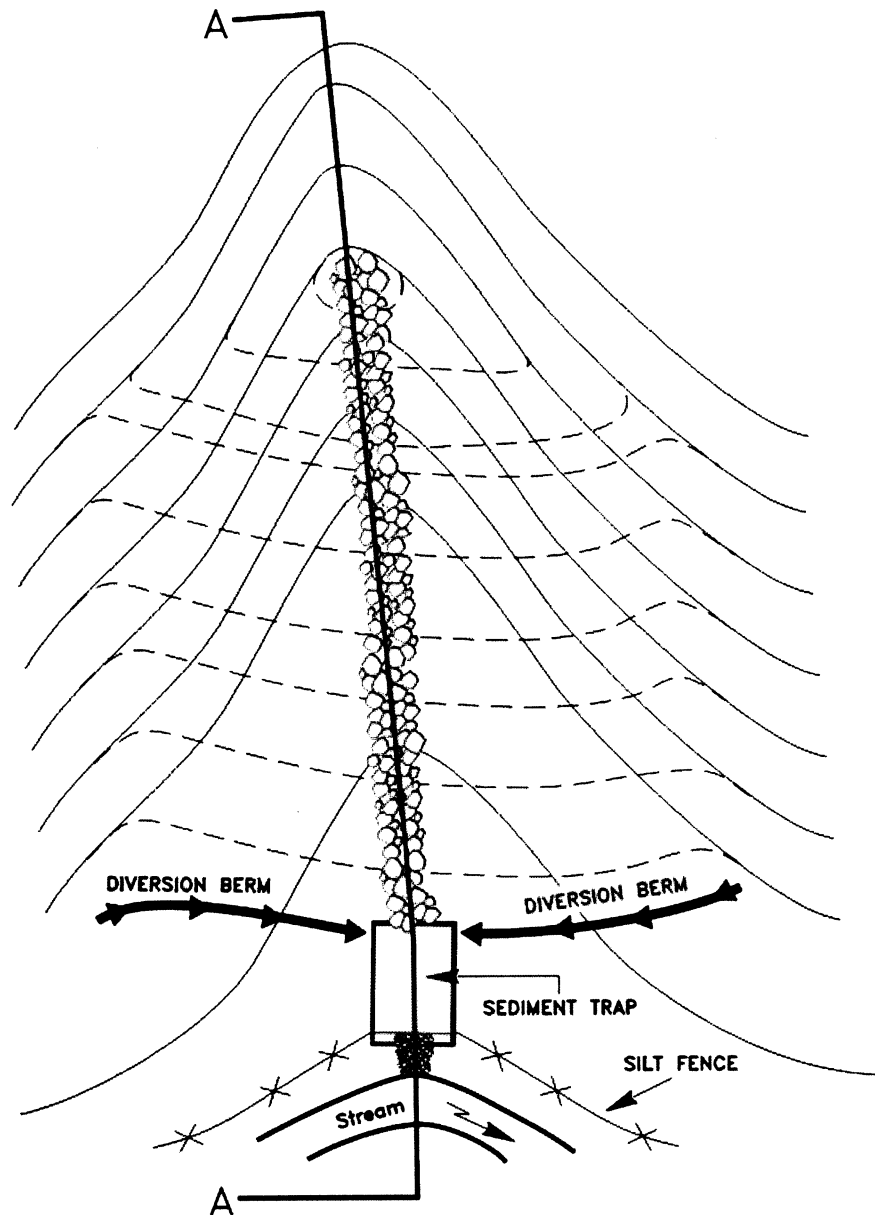
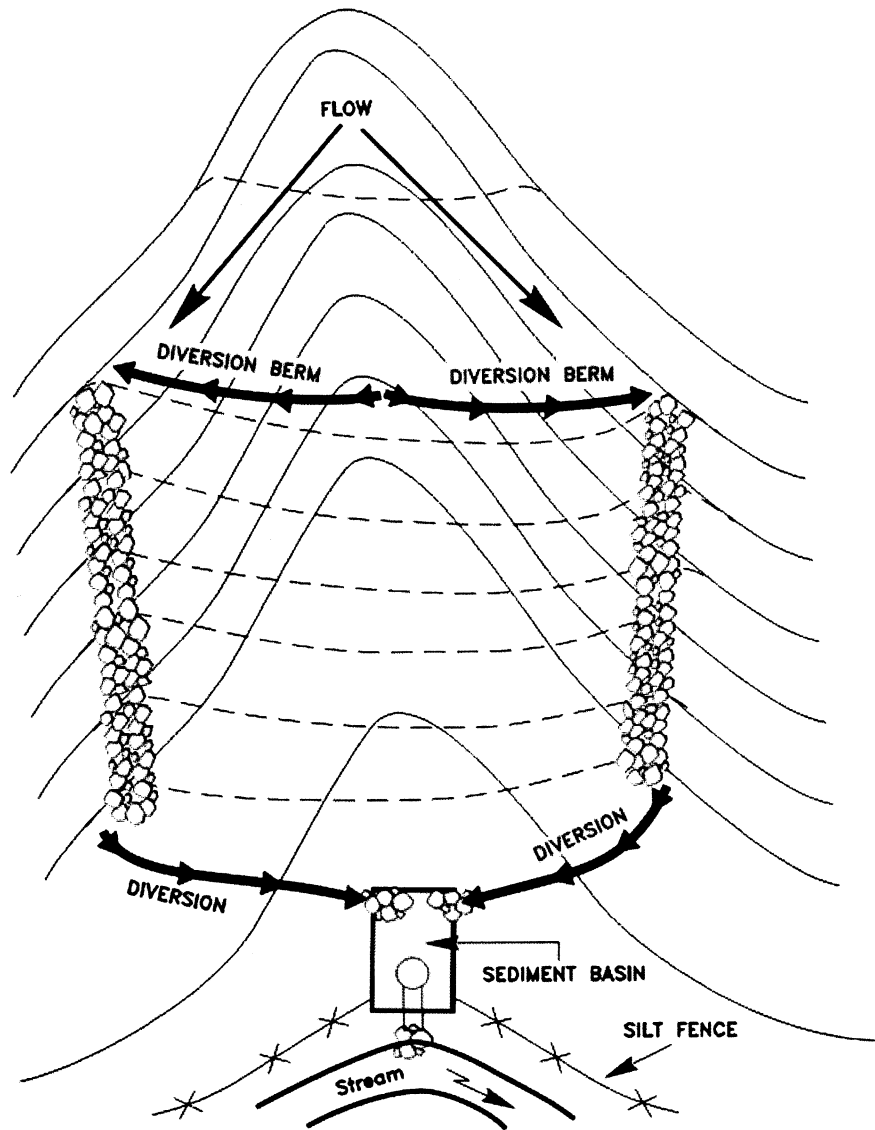


FIGURE 3.20.6

# FILL WITH ROCK CHANNELS



## 3.21 - INSTREAM BMPs

---

### ***Introduction***

Many times construction activities have to take place within the streambed. Utility construction in particular, by virtue of its linear nature, frequently crosses and negatively impacts streams. Large amounts of sediment can be generated when equipment is working in a stream. The only way that sediment be reduced during instream construction is by isolating the work or “working in the dry”. By isolating the work area from the stream flow much of this sediment can be eliminated. There are several techniques that can be used to dewater and isolate the work area.

While this practice emphasizes utility construction each of these techniques can be used for any type of instream construction activity.

When the project will last more than 72 hours and the work area has to be completely dewatered such as when culverts are being installed, the temporary stream diversion can be used.

Runoff from the shore and approaches can also produce sediment, as can improperly stabilized streambanks.

### ***Conditions Where Practice Applies***

These practices are applicable to all instream construction activities such as utility lines, bridge piers and abutments, retaining walls and/or bank stabilization, culverts, water intakes and pipe outfalls. Temporary isolation techniques are used when construction within a full flowing stream will create severe environmental impacts due the resulting sedimentation.

Under most circumstances the pump around technique will be sufficient to dewater the work site. However, a full stream diversion is required when the construction of an instream structure will take place across the entire channel width and the pump around or flume would not be sufficient to handle the anticipated stream flows. It is also applicable when the construction timeframe is longer than 72 hours and there is sufficient lead-time to construct the new channel and stabilize it.

The stream diversion technique only works if there is sufficient room to install the diversion and construct the structure.

These practices are not permanent. A full engineering design is required if a stream channel has to be relocated into new permanent channel. There are numerous requirements, including natural stream design, in the Army Corps of Engineers’ Section 404 Permit, WV DEP Section 401 Certification and the Public Lands Corporation Right-to-Enter.

### ***Planning Considerations***

The production of significant amounts of sediment is inevitable when conducting construction activities in a stream. There is also a potential

for excessive sediment loss into a stream by runoff from the adjoining streamside and approach areas.

It is often a difficult task to decide what type of control to use when working in a stream. The ONLY way to limit sediment is to work “in the dry”. Any attempt to trap sediment in the stream below the construction site is pointless. There are several very effective methods that can be used to work in the dry and prevent the creation of sediment. One, “boring and jacking” or horizontal directional drilling of pipe under the streambed, which prevents any disturbance within the watercourse, is the least destructive and preferred method. However, boring is expensive and sometimes impractical. But when working in very high quality streams such as Tier 2.5 or 3 it may be the only method allowed. In others it may be convenient as a continuation of an ongoing project, such as extending a Division of Highways’ road bore underneath an adjacent stream.

However, when instream work is unavoidable, consideration must be given to providing adequate mitigation of sediment loss while minimizing the amount of encroachment and time spent working in the channel. There are several methods available that completely isolate the work area from the stream flow. These “dry ditch” measures include pumping around, flume pipes, cofferdams and stream diversions. Each of these techniques work in smaller streams and during periods of low flows.

In larger streams where isolation techniques become difficult or impossible to install, there can be some “give and take”. Sometimes there can be less damage to the environment if minimal instream sediment control takes place. When using these “wet ditch” methods it is necessary to minimize the amount of time spent working in the stream, quickly stabilize the work area and provide substantial controls on the approach areas. However, when the construction within streambed and banks will take an extended period of time, consideration should be given to substantial in-stream controls or to construct a stream diversion.

As a result of the difficulty in choosing the right method for a utility stream crossing, designers should always make a site visit of proposed crossing to ensure that the most appropriate method is chosen. The designer should also be aware that most instream construction projects are subject to federal section 404 Army Corps of Engineers, NPDES Construction Permit and Public Lands Corporation’s Right of Entry.

Included in this BMP are several methods (with varying construction time and stream size scenarios) which allow for “work in the dry” to prevent excessive sedimentation damage. By no means are these methods all-inclusive. As with other control measures, site-specific design and innovative variations are encouraged.

All planning should begin with an onsite evaluation. The following items should be considered when designing a stream crossing..

Site Conditions

- Channel Cross Section
- Channel Bed (Solid Rock, Cobbles, Soil)
- Bank Slopes
- Bank Stability
- Flow Characteristics of Stream

Season

Suitable Location

- Avoid bends of the streams
- Avoid Wetlands or other environmental sensitive areas

Other Considerations

- Applicability of other permitting regulations (See Permitting section of this manual)
- Endangered Species

Floodplain encroachment

Determine the appropriate construction method

***General Design  
Criteria***

1. The drainage area should be no greater than one square mile (640 acres).
2. All filter cloth used in the construction of the utility crossing must conform to physical requirements noted in GEOTEXTILE.
3. Water diverting structures should be used at all trenching and/or construction road approaches (50 feet on either side of the crossing).
4. Design criteria more specific to each particular crossing can be found in the following drawings.
5. All construction activities must meet the applicable Minimum Standard for Instream Construction.
6. Bank stabilization should be based on soil erodibility and bank-full velocity. Restabilization shall consist of the installation of ungrouted riprap on all disturbed streambank areas (or on the area 6 feet on both sides of the centerline of its utility trench, whichever is greater) with slopes of 3:1 or greater. Refer to RIPRAP and the drawings in this section for installation requirements. For slopes of 3:1 or less, vegetative stabilization may be used, pending approval by the Division of Water and Waste Management. Stabilization of its streambed and banks and the approach areas should occur immediately following the attainment of final grade.
7. Provide sediment control such as SILT FENCE, SUPER SILT FENCE or DIVERSIONS and SEDIMENT TRAP on either side of the stream

***Construction  
Criteria***

The following specifications are for stream crossings such as would be needed for a utility line crossing. Each can be used for other instream activities with little or no modification. The stream diversion will typically be used for larger projects.



The least damaging and preferred method is “boring and jacking” or horizontal directional drilling..

Open cut dry ditch methods - In these methods the work area is isolated by diverting the stream around the pipeline crossing. The trench is then excavated, the pipe installed and backfilled and the stream and streambank stabilized, all “in the dry”.

The three main methods of dry ditch crossings are the pump around, cofferdam and the flume pipe methods. In the pump around, the stream is dammed and water is moved around the construction site with a pump. In the cofferdam method, impervious barriers are used to isolate part of the work area. Typically half the stream is dammed and the pipe is laid before moving to the other half. In the flume method, the stream is dammed and the stream is bypassed in a culvert that spans across the work area.

One negative to using these methods is the installation and removal of the dam can create a good bit of sediment. Other problems include: leakage around/underneath dam, dam and flume failures, insufficient pump capacity, flooding, and inadequate maintenance.

### **Pump-Around**

The pump around method is the preferred technique to dewater a work site. It is the simplest method if the necessary equipment is available. This method requires damming the stream with a non-erodible material covered with an impervious membrane to create a pool upstream of the work area where a pump intake can be placed. Depending on the gradient of the stream another dam below the work area may be needed. In between the dams a dry work area is created. A pump moves the water around the construction area where the installation of the pipe can be done in the dry. It can be labor intensive when placing the sand or gravel bags. Obtaining sand bags in West Virginia can also be problematic.

Key issues:

1. Provide adequate sediment and erosion control on the approaches.
2. Construction should be preformed in low flow periods.
3. Use a pump or pumps sufficiently large to pump the entire stream flow around the site
4. Construct a dam impervious to water.
5. The inlet of the pump is to be suspended above the streambed in order to prevent sucking mud and sediment.
6. The discharge point must be stabilized with rock to disperse the energy and prevent erosion.

## Cofferdam

Cofferdams have long been used to provide dry work areas. Their use is declining as other methods gain ground. However in the right circumstance they can still provide adequate performance. Cofferdams are labor intensive and costly and can be difficult to seal to prevent infiltration of water. To be used when stream diversion is not practical and stream is wide enough (10 feet or wider) to make cofferdam installation practical.

If the stream needs to be diverted more than 75% of its width, then Diversion Channel criteria should be followed.

- a) Construction should be performed in low flow periods
- b) Crossing shall be accomplished in a manner that will not inhibit the flow of the stream.
- c) Dewatering to be accomplished in accordance with section for DEWATERING.
- d) Cofferdams should not extend beyond  $2/3$  the width of the streambed to allow for stream flows.
- e) As with all utility line crossings, approach areas should be controlled with perimeter measures (silt fence, diversions, etc.)
- f) Remove large rocks, woody vegetation, or other material from the streambed and banks that may get in the way of placing the stone, sandbags, sheet metal, or wood planks or installing the utility pipe or line.
- g) Form a cofferdam by placing stone or sandbags, jersey barriers (or other non-erodible materials), covered by an impervious material in a semicircle along the side of the stream in which the utility installation will begin. It must be surrounded and underlain with filter cloth as shown in the drawing. The height of and area within the dam will depend upon the size of the work area and the amount of stream flow. Stack materials as high as will be necessary to keep water from overtopping the dam and flooding the work area.
- h) Cofferdams should be no more than one half the height of the stream bank plus one-foot.
- i) When the stream flow is successfully diverted by the cofferdam, dewater the work area into a dewatering structure.
- j) Stabilization of the crossing, streambanks, and approaches should occur immediately following completion of the crossing.

There are commercially available cofferdams now on the market. These water filled bladders or standing steel supports can be installed quickly and can provide cost savings over traditional hardened cofferdams. Their installation and removal can lessen the creation of sediment. Some of the products available are Portadam, Dam-it Dams, and Aqua-Barrier

## Flume Pipe

A flume pipe crossing consists of two impervious dams across a stream with one or more culverts installed to pass the stream flow across the work area. A flume pipe crossing can be used when in-stream construction will last less than 72 hours and stream is narrow (less than 15 feet wide) or wider in low water conditions. Ideal for gas pipeline, sewerline and waterline construction especially when used in conjunction with and as an extension of a Vehicular Stream Crossing.

- a) The flume pipe crossing must be made operational prior to the start of the instream construction.
- b) A large flume pipe(s) or culvert(s) of an adequate size to support normal water channel flow (see Table 3.21.1) shall be installed in the streambed across the proposed pipeline trench centerline. Riprap, jersey barrier or sandbags shall be placed close to each end of the flume pipe so as to dam off the creek forcing the water to flow through the flume pipe (see drawing). Sandbags are the preferred method for diverting water into the flumes. The commercial cofferdams can be used if a tight seal can be created.
- c) The entrapped water in the work area can then be pumped into an approved Dewatering Device. The trench can then be dug under the flume pipe. The pipe sections will then be installed to the proper depth under the flume pipe. After the pipe is installed, the ditch will be backfilled and restabilization shall be carried out.
- d) Reclamation of the stream banks will occur the same day as the installation of the pipe is completed. Restabilization shall consist of the installation of ungrouted riprap on all disturbed streambank areas (or on the area 6 feet on both sides of the centerline of the utility trench, whichever is greater) with slopes of 3:1 or greater. Refer to the specification for Riprap, for installation requirements. For slopes of 3:1 or less, vegetative stabilization with or without Rolled Erosion Control Product may be used, pending approval by the Division of Water and Waste Management. Stabilization of its streambed and banks and the approach areas should occur immediately following the attainment of final grade.
- e) After completion of backfilling operation and restoration of stream banks and leveling of streambed, the flume pipe can then be removed. The stone can be removed or spread as stabilization of the streambed depending on permit requirements. Sediment control in approach areas shall not be removed until all construction is completed in the stream crossing area and the contributing drainage area to the device is stabilized. All ground contours shall be returned to their original condition.

Drainage Area (Acres)	Table 3.21.1 Average Slope of Watershed			
	1%	4%	8%	16%
	Culvert Size			
1 – 25	24	24	30	30
26 - 50	24	30	36	36
51 – 100	30	36	42	48
101- 150	30	42	48	48
151 - 200	36	42	48	54
200 - 250	42	48	60	60
251 - 300	42	48	60	60
301 - 350	42	48	60	60
351 - 400	42	54	60	60
401 - 450	42	54	60	72
451 - 500	42	54	60	72
501 - 550	48	60	60	72
551 - 600	48	60	60	72
601 - 640	48	60	72	72

Note: Table is based on USDA-SCS Graphical Peak Discharge Method for 2-year frequency storm event, CN = 65; Rainfall depth = 3.5 inches (average for Virginia). Source: Va. DSWC

### Open cut wet ditch

This technique does not use any method to divert the stream around the work area. The utility line is installed and backfilled while the river/stream continues to run through the site. The benefits are low cost and a quick completion time. However, this type of crossing produces some very negative impacts. These include severe pollution from greatly increased total suspended sediment (TSS) concentrations, changes in channel morphology, and localized destruction of aquatic ecosystems. These impacts can be somewhat mitigated by a quick completion time.

DEP does not recommend this type of crossing unless a creating a dry ditch is impossible. There shouldn't be any significant rain forecast during the entire construction timeframe. This method may be used with prior approval when other preferred methods are proven to be unfeasible.

Stabilization of the crossing, streambanks, and approaches should occur immediately following completion of the crossing.

The wet ditch method may be used when the following conditions are met:

- a.) When the distance across the flume pipes become too wide for a backhoe to dig from both sides and connect the trench underneath the pipes. This measurement would vary according to the number of flume pipes, the height of the stream banks, the

size and digging angle of the backhoe, the depth to bed rock and ease of digging.

- b.) When the crossing can be accomplished within 72 hours. However, the contractor should make every effort to complete the crossing in one working day. All disturbed streambanks must be stabilized the same day the construction is finished
- c.) When the crossing is at right angles ( $\pm 5^\circ$ ) to the stream channel.
- d.) If water is pumped during the installation of the pipe it must be treated as per the DEWATERING specification.

This method is also applicable to small intermittent and ephemeral streams that are completely dry and no rain is forecast for the entire installation timeframe.

### **Stream Diversion Bypass**

Temporary stream diversions are used when construction within a full flowing stream will create severe environmental impacts due the resulting sedimentation. This technique also provides a safe and dry work area. Typically a stream diversion is required when the construction of an instream structure will take place in the entire channel and the pump around or flume dewatering techniques would not be sufficient to handle the anticipated stream flows. It is also applicable when there is a significant construction timeframe. A stream diversion is most commonly used when a large fill is placed across a valley and a culvert is installed to carry the stream such as when building a road or dam.

Once started, any work to relocate the stream and install the permanent structure shall not be discontinued until it is completed. The connection to the natural channel should be performed under dry conditions

Diversion channels only work if there is sufficient room to both install the diversion and construct the structure.

### **Construction Specifications**

- a) The diversion channel crossing must be operational before the construction activity starts so that construction can occur "in the dry").
- b) Minimum width of bottom shall be four feet or equal to average width of existing streambed, whichever is greater.
- c) Maximum steepness of side slopes shall be 2:1. Depth and grade may be variable, dependent on site conditions, but shall be sufficient to ensure continuous flow of water in the diversion.
- d) There are three types of diversion channel linings that can be used, based upon expected velocity of bankfull flow. Refer to the drawing and the accompanying table.

- e) The seed mix for the grass liner is to be in accordance with the Temporary Seeding” section. An average growth of two inches in height shall be achieved throughout the diversion with 70% cover before water is turned into it.
- f) Stream diversion liners shall be entrenched at the upstream end as shown in the stream channel drawing for ROLLED EROSION CONTROL PRODUCTS. Fabric liners must be stapled every three feet. Polyethylene liners shall be weighted with rock along the base of the side slope.

<b>Table 3.21.2 STREAM DIVERSION LININGS</b>		
Acceptable Lining Material	Classification	Maximum Velocity
Grass and Matting	TYPE A	5.0 f.p.s.
Geotextile Filter Cloth	TYPE B	8.0 f.p.s.
Class I Riprap and Filter Cloth	TYPE C	13.0 f.p.s.

- g) Start installing stream diversion liners at the downstream end. Stream diversion liners should be overlapped 18 inches (upstream over downstream) when a continuous liner is not available or is impractical. Overlaps along the sides should be made such that a liner is placed in the stream diversion bottom first and additional pieces of liner on the slopes overlap the bottom piece by a minimum of 18 inches. See ROLLED EROSION CONTROL PRODUCTS for drawings.
- h) Stream diversion liners shall be entrenched at the top of the diversion slopes (slopes breaks) along with a line of silt fence. Silt fence may be excluded if the diversion liner is extended to such a point that siltation of the stream will not occur. If silt fence is excluded, the diversion liner must be secured. Liners shall extend from slope break to slope break as shown in the drawing.
- i) Non-erodible materials such as riprap, jersey barriers, sandbags, or sheet piling, shall be used as flow barriers to divert the stream away from its original channel and to prevent or reduce backup into the lower end of the construction area.
- j) The downstream and upstream connection to the natural channel should be performed under dry conditions and may be so accomplished by use of sandbag cofferdams. The downstream

flow barrier is to be removed prior to the upstream barrier when preparing a stream diversion for the transport of water.

- k) The diversion should be sealed off at the down stream end and then backfilled once water is put back in its original channel.
- l) Stream should be re-diverted only after restabilization of original streambed and banks is completed or the inlet and outlet of the culvert pipe is finished. Stabilization of the streambed and banks and the approach areas should occur immediately following the attainment of final grade.
- m) Temporary bypass channels should be backfilled and properly stabilized by riprap or RECPs to prevent the stream from reestablishing the path.
- n) Any water pumped from this operation shall be directed into an approved Dewatering Structure.

### **Alternative Technique**

Designers need to know that another way of installing culverts is possible. Traditionally a new culvert was installed as close to the original alignment of the existing stream as possible. This entails the construction of a significant stream diversion. If the conditions are right there is another way.

An alternative to building a stream diversion is to design and install the new culvert outside the existing stream channel and use the existing natural channel as the bypass. With this method there is much less likelihood of erosion and sedimentation of a temporary channel. Time can also be saved by not having to construct a whole new channel. The only “instream” work will be the tying in the old channel into the inlet and outlet channels of the new culvert or spillway.

It is sometimes likely that a combination of existing and new channel will be needed.

### ***Other Considerations***

Stream crossings must be approached as a separate project. All materials necessary to construct the crossing must be on site and ready to use. If possible, pipe should be coupled on shore and then pulled across and placed in the trench in one operation.

During reclamation it is not necessary to create a perfectly smooth stream bottom. Elevated spots should be removed but in most cases the bed load and scour from next high water event will eliminate all signs of the crossing. On smaller crossings the bed load from one flood event can fill the entire trench. In these cases, anchoring the pipe with river weights or critically placed buckets of gravel may be all that is required to reclaim the creek bottom.

It is important to use machinery that is in good mechanical shape. Use newer pieces of equipment that are less likely to have fluid leaks. Maintain spill containment kits inside each piece of equipment working in moving water. Maintain hydraulic hoses on equipment that is used for work in or around streams.

Refuel and maintain vehicles a minimum of 100 feet from of the stream. A comprehensive spill containment and cleanup kit should be readily available on site.

### ***Maintenance***

Structures and erosion and sediment controls should be inspected after every rainfall of 0.5 inches or more and at least once a week and repair all damages immediately. Check for debris especially flotsam clogging the inlet to the culverts. All deposited materials and obstructions must be removed immediately.

In general inspect all active stream crossings at the end of each day to make sure that the construction materials are positioned securely. This will ensure that the work area stays dry and that no construction materials float downstream. The contractor should carefully watch the weather forecast and coordinate the installation based on the proper conditions.

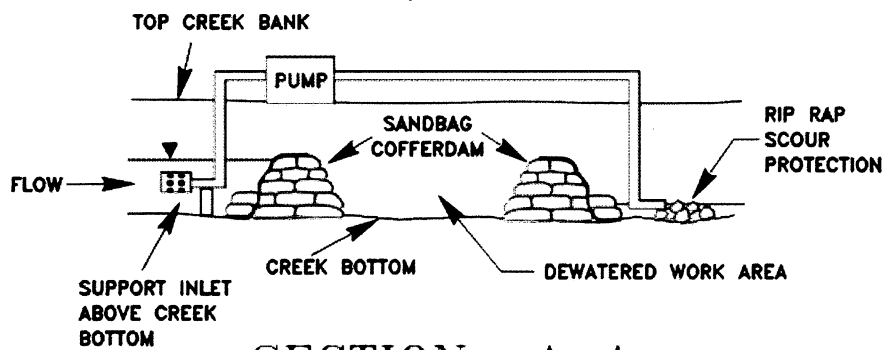
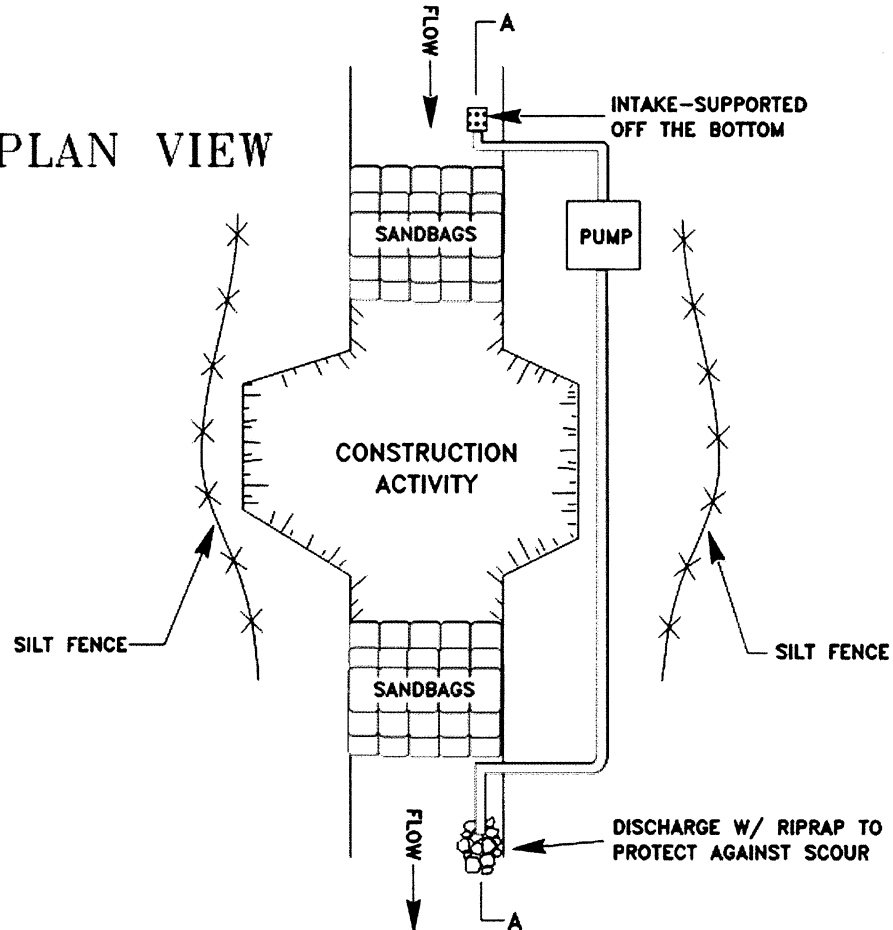
Cleanup and stabilize the entire stream crossing site immediately upon completion of the installation of the pipe. One exception would be on a natural gas transmission lines where the attached vehicle crossing will be used for an extended time. Stabilize all other areas immediately.



FIGURE

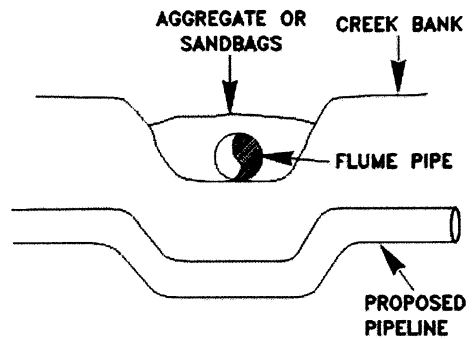
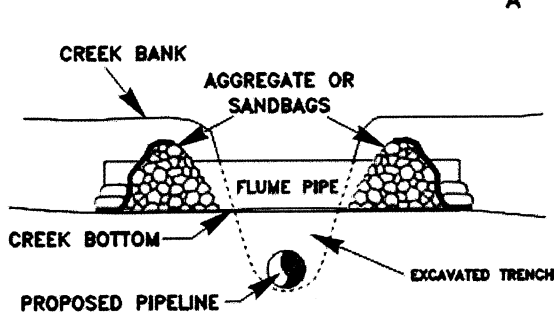
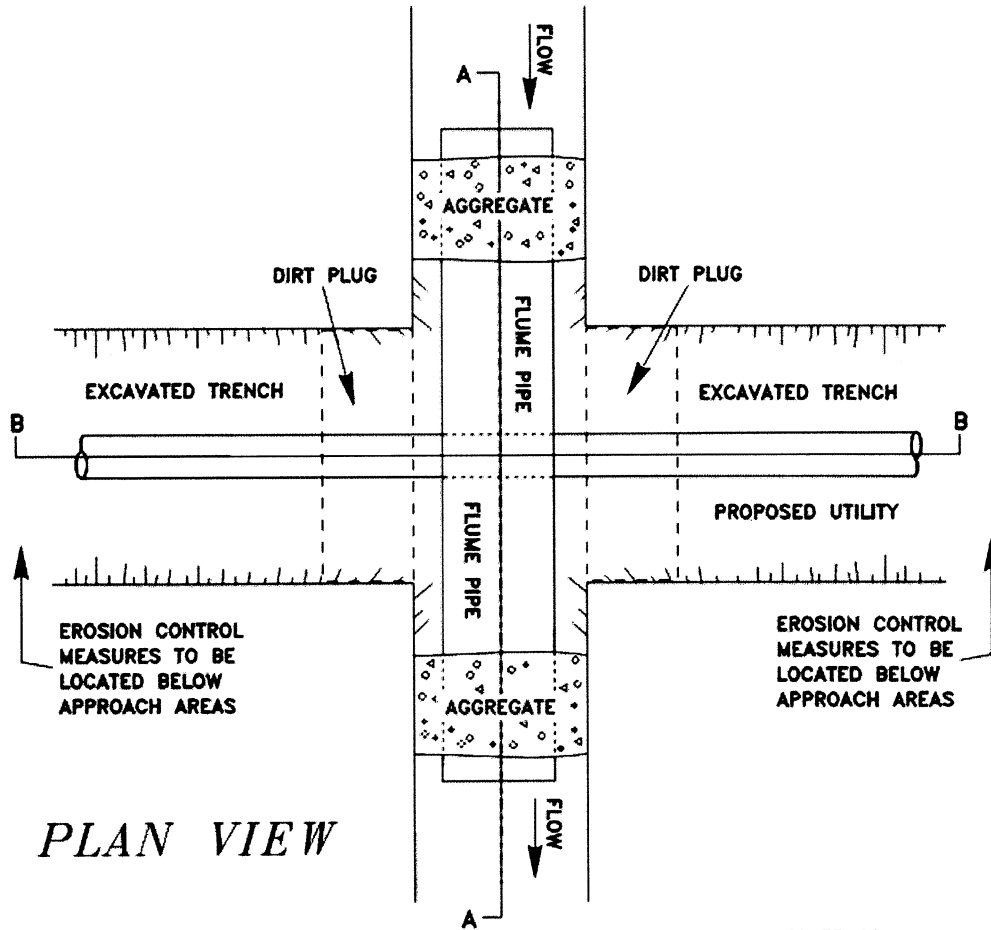
# PUMP AROUND

## PLAN VIEW



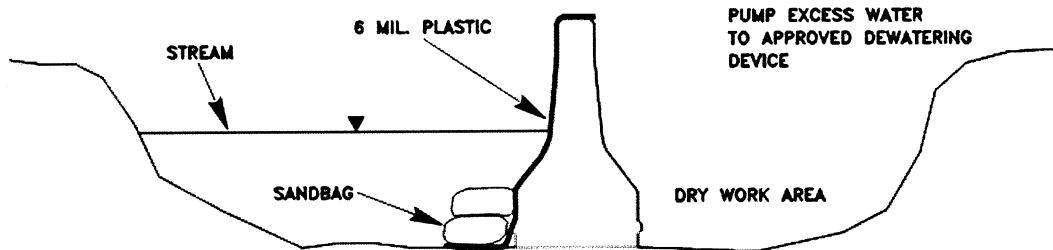
## SECTION A-A

# FLUME PIPE CROSSING

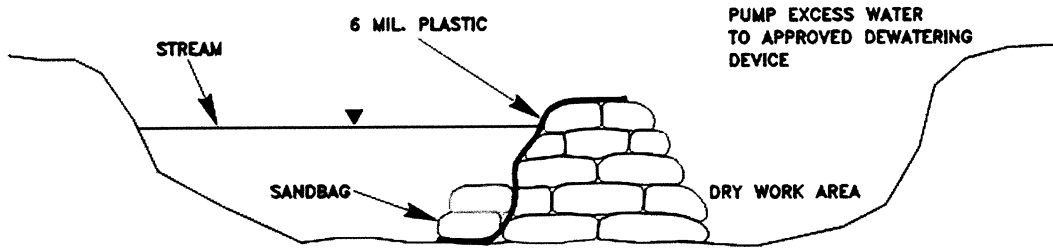


SOURCE: Va. DSWC

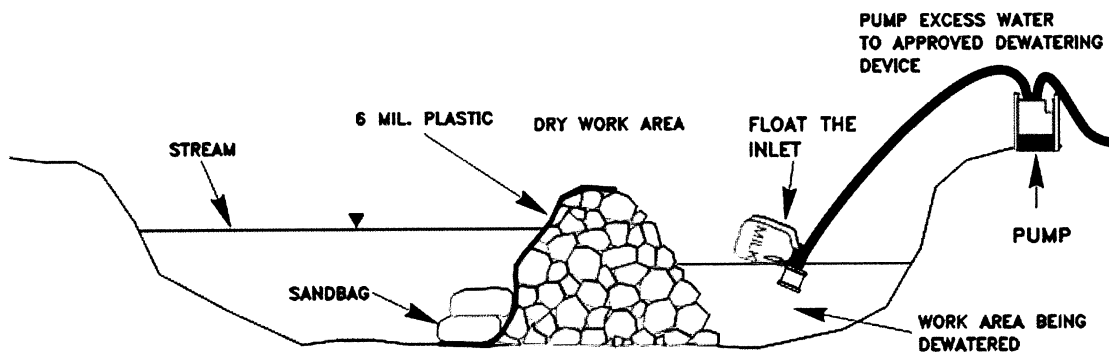
# COFFERDAMS



*JERSEY BARRIER COFFERDAM*



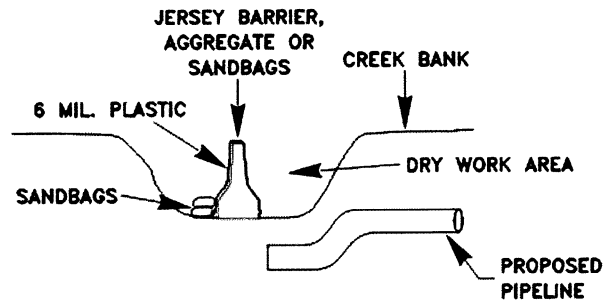
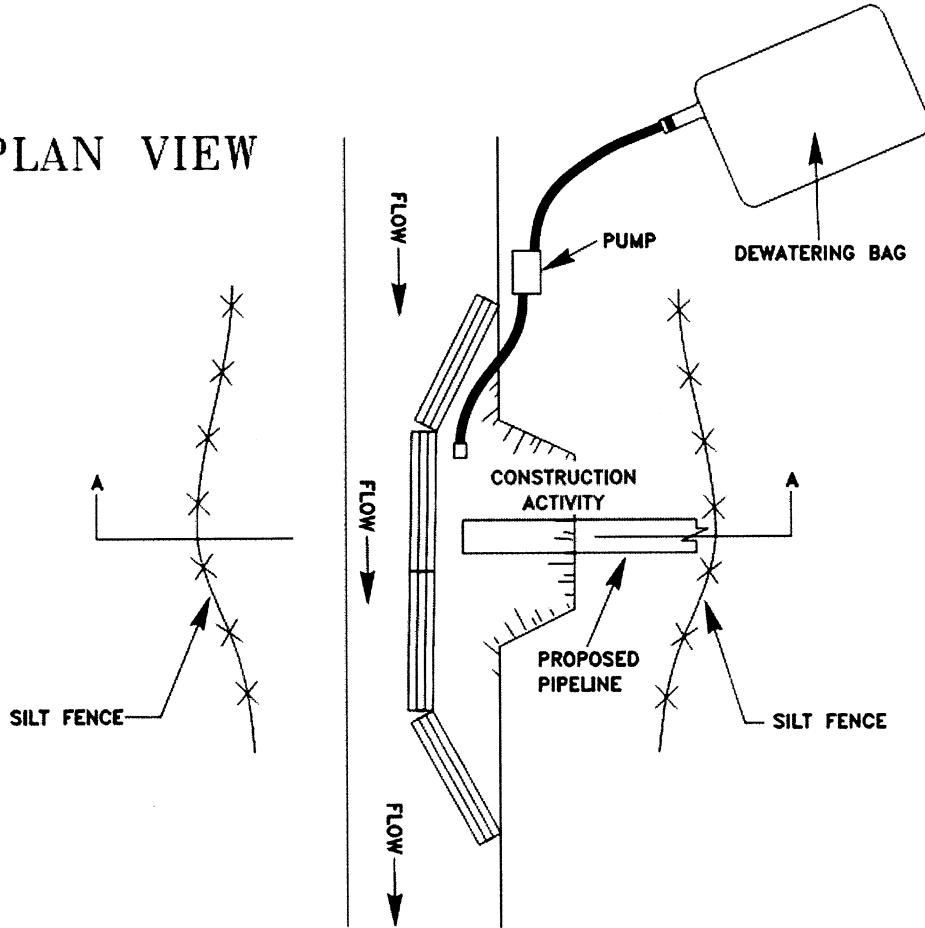
*SAND or GRAVEL BAG COFFERDAM*



*ROCK COFFERDAM*

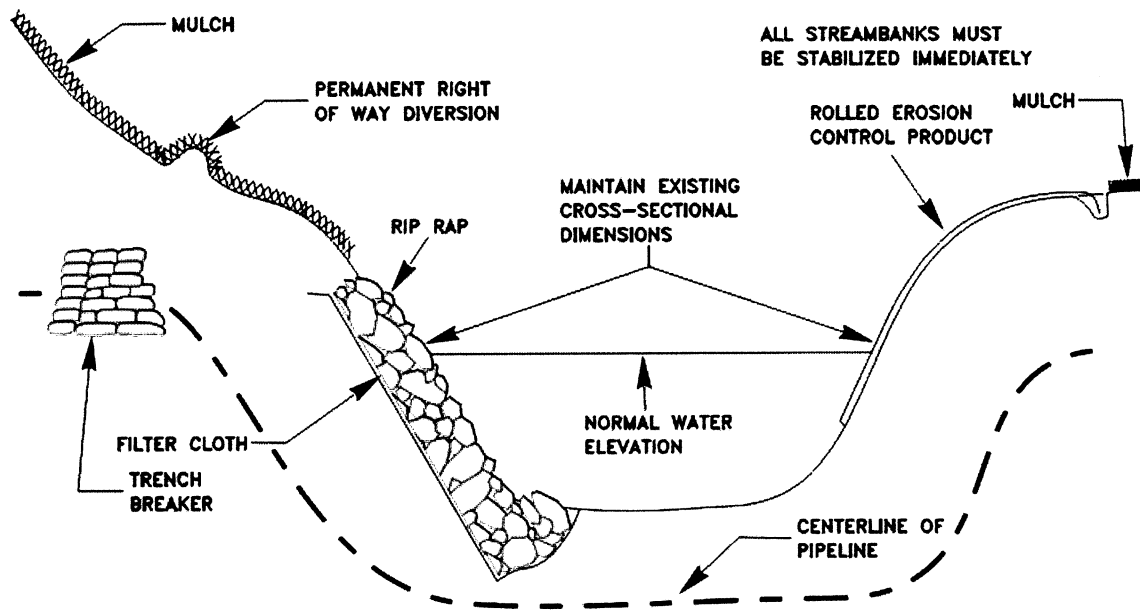
# COFFERDAM CROSSING

## PLAN VIEW



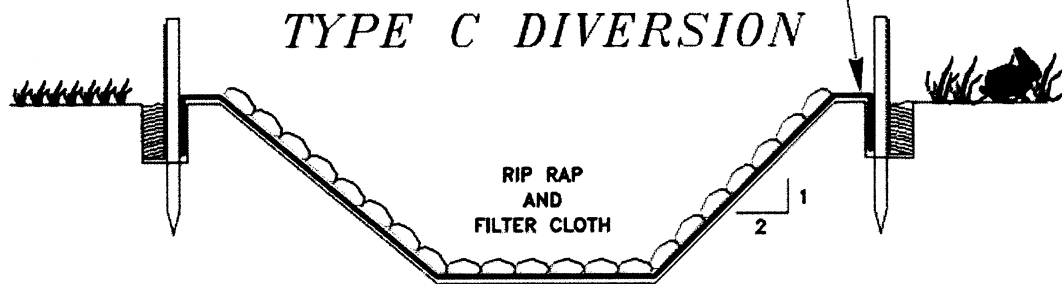
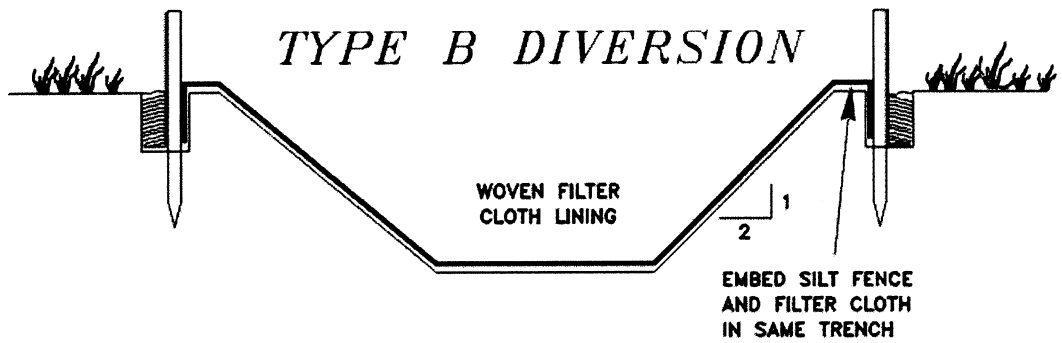
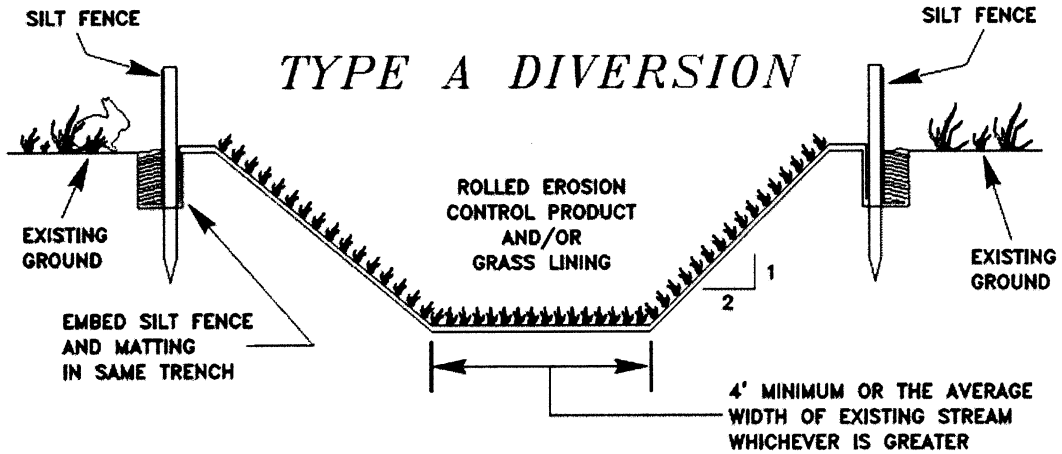
## SECTION "A - A"

# STREAM BANK STABILIZATION SHOWING VARIETY OF E/S CONTROLS



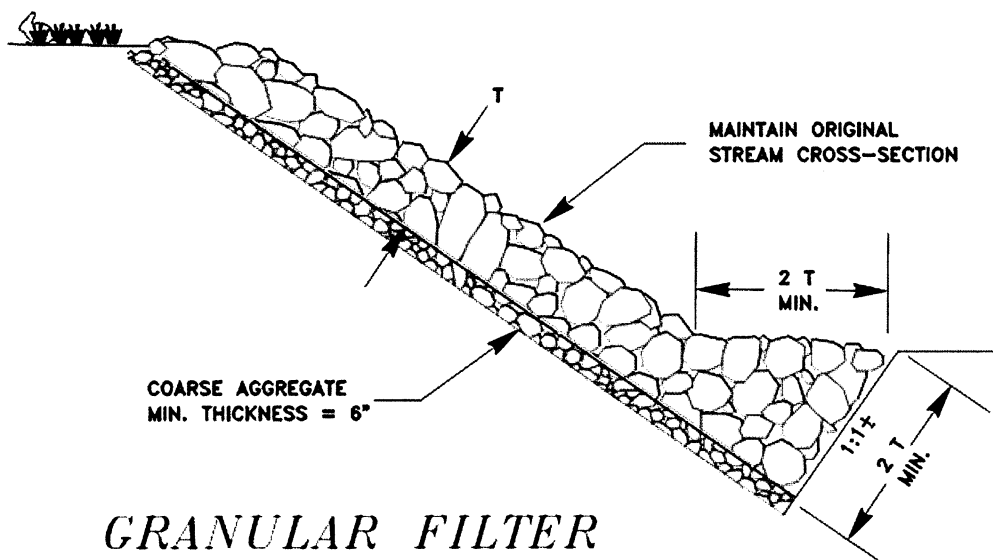
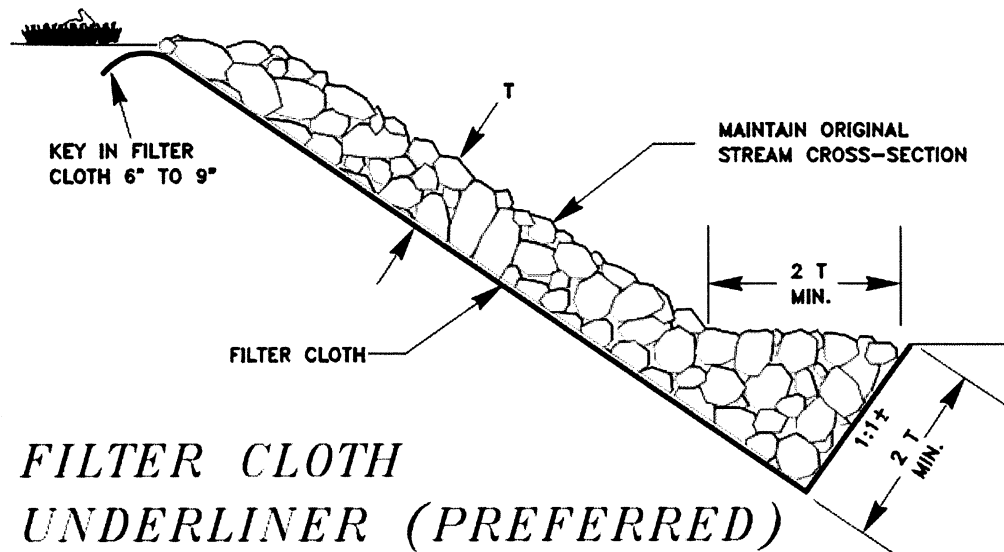
ADAPTED FROM DOMINION RESOURCES

# DIVERSION CHANNEL CROSSING



SOURCE: ADAPTED FROM VA DSWC

# TOE AND UNDERLAYMENT REQUIREMENTS FOR BANK STABILIZATION



SOURCE: Adapted from VDOT Drainage Manual

## **Temporary Vehicular Stream Crossing**

A temporary structural span (includes bridges, round pipes, pipe arches, or oval pipes) installed across a watercourse for use by construction traffic. These structures are used to provide a means for construction traffic to cross a stream without damaging the channel or banks and to keep sediment generated by construction traffic out of the stream.

A rule of thumb is that if there are more than two crossings a stabilized stream crossing must be installed. As an example, if during the clearing and grubbing a bulldozer has to cross a stream going out and coming back just once a culverted stream crossing is not necessary. However if the route the bulldozer takes becomes the access to the site and more than one other vehicle has to cross the stream then a crossing a specified here needs to be installed.

Generally applicable to streams with drainage areas less than 1 square mile (660 acres).

For streams larger than 1 square mile the structure should be designed by a registered professional engineer, using professionally recognized methods that will more accurately define the actual hydrologic and hydraulic parameters that will affect the functioning of the structure.

### **Design Criteria**

#### **Temporary Bridge Crossing**

- a. Bridges may be designed in various configurations. However, the materials used to construct the bridge must be able to withstand the anticipated loading of the construction traffic.
- b. Crossing Alignment - The temporary waterway crossing shall be at right angles to the stream. Where the approach conditions dictate, the crossing may vary 15E from a line drawn perpendicular to the centerline of the stream at the intended crossing location.
- c. The centerline of both roadway approaches shall coincide with the crossing alignment centerline for a minimum distance of 50 feet from each bank of the waterway being crossed. If physical or right-of-way restraints preclude the 50 feet minimum, a shorter distance may be provided. All fill materials associated with the roadway approach shall be limited to a maximum height of 2 feet above the existing flood plain elevation.
- d. A water diverting structure such as a dike or swale shall be constructed (across the roadway on both roadway approaches) 50 feet (maximum) on either side of the waterway crossing. This will prevent roadway surface runoff from directly entering the waterway. The 50 feet is measured from the top of the waterway bank. If the roadway approach



is constructed with a reverse grade away from the waterway, a separate diverting structure is not required.

e. Appropriate perimeter controls such as SILT FENCE, SUPER SILT FENCE and/or DIVERSION and SEDIMENT TRAP must be employed when necessary along banks of stream parallel to the same.

f. Clearing and excavation of the streambed and banks shall be kept to a minimum.

g. The temporary bridge structure shall be constructed at or above bank elevation to prevent the entrapment of floating materials and debris.

h. Any abutments shall be placed parallel to and on stable banks.

i. Bridges shall be constructed to span the entire channel. Instream piers should be kept to a minimum. Any work within the normal high water mark will require a Public Lands Corporation Right-of-Entry, a Army Corps of Engineers 404 Permit and WV DEP 401 Certification..

j. Stringers shall either be logs, sawn timber, pre-stressed concrete beams, metal beams, or other engineer-approved materials.

k. Curbs or fenders may be installed along the outer sides of the deck. Curbs or fenders are an option that will provide additional safety and keep mud from flowing over the edge into the stream.

l. Bridges should be securely anchored at only one end using steel cable or chain. Anchoring at only one end will prevent channel obstruction in the event that floodwaters float the bridge. Acceptable anchors are large trees, large boulders, or driven steel anchors. Anchoring shall be sufficient to prevent the bridge from floating downstream and possibly causing an obstruction to the flow.

m. All areas disturbed during installation shall be stabilized immediately.

n. When the temporary bridge is no longer needed, all structures including abutments and other bridging materials should be removed immediately.

o. Final clean up shall consist of removal of the temporary bridge from the waterway, protection of banks from erosion, and removal of all construction materials. All removed materials shall be stored outside flood plain of the stream. Removal of the bridge and clean up of the area shall be accomplished without construction equipment working in the waterway channel.

### **Temporary Culvert Crossing**

a. 2" to 4" Coarse Aggregate or larger will be used to form the crossing. **DO NOT USE ERODIBLE MATERIAL FOR CONSTRUCTION OF THE CROSSING.** The depth of stone cover over the culvert shall be equal to one-half the diameter of the culvert or 12 inches, whichever is greater. If multiple culverts are used, they shall be separated by at least 12 inches of compacted aggregate fill. To protect the sides of the stone from erosion, riprap shall be used.

b. If the structure will remain in place for up to 6 months, the culvert shall be large enough to convey the bankfull flow without appreciably altering the stream flow characteristics. To insure the proper capacity the culvert(s) should have cross sectional area equal to the cross sectional area of the stream at bankfull.

Should the structure will remain in place 6 months or longer, the culvert shall be large enough to convey the flow from a 10-year frequency storm. In this case, the hydrologic calculations and subsequent culvert size must be done for the specific watershed characteristics. If the structure must remain in place over 1 year, a qualified registered Professional Engineer must design it as a permanent measure.

c. Multiple culverts may be used in place of one large culvert if they have the equivalent capacity of the larger one. The minimum sized culvert that may be used is 18 inches. Two 18-inch culverts do not replace a 36-inch culvert.

d. All culverts shall be strong enough to support their cross-sectioned area under maximum expected loads.

e. The culvert(s) shall extend a minimum of five foot beyond the upstream and downstream toe of the aggregate placed around the culvert.

f. The slope of the culvert shall be at least 0.25 inch per foot.

g. Crossing Alignment - The temporary waterway crossing shall be at right angles to the stream. Where approach conditions dictate, the crossing may vary 15 from a line drawn perpendicular to the centerline of the stream at the intended crossing location.

h. The centerline of both roadway approaches shall coincide with the crossing alignment centerline for a minimum distance of 50 feet from each bank of the waterway being crossed. If physical or right-of-way restraints preclude the 50 feet minimum, a shorter distance may be provided. All fill materials associated with the roadway approach shall be limited to a maximum height of 2 feet above the existing flood plain elevation.

i. The roadway approaches to the structure shall consist of stone pads meeting the following specifications:

- 1) Stone: 2'' - 4''
- 2) Minimum thickness: 6 inches
- 3) Minimum width: equal to the width of the structure
- 4) Minimum length: 50 feet on either side of the crossing.

j. A water diverting structure such as a swale shall be constructed (across the roadway on both roadway approaches) 50 feet (maximum) on either side of the waterway crossing. This will prevent roadway surface runoff from directly entering the waterway. The 50 feet is measured from the top of the waterway bank. If the roadway approach is constructed with a reverse grade away from the waterway, a separate diverting structure is not required.

k. Appropriate perimeter controls such as SILT FENCE, SUPER SILT FENCE and/or DIVERSION and SEDIMENT TRAP must be employed when necessary along banks of stream parallel to the same.

l. Clearing and excavation of the streambed and banks shall be kept to a minimum.

m. The invert elevation of the culvert shall be installed on the natural streambed grade to minimize interference with fish migration.

n. Filter cloth shall be placed on the streambed and streambanks prior to placement of the pipe culvert(s) and aggregate. The filter cloth shall cover the streambed and extend a minimum of six inches and a maximum of one foot beyond the end of the culvert and bedding material. Filter cloth reduces settlement and improves crossing stability. The required physical qualities of the filter cloth should be sufficient for the anticipated loads.

o. When the crossing has served its purpose, all structures including culverts, bedding and filter cloth materials shall be removed. Removal of the structure and clean up of the area should be accomplished without construction equipment working in the waterway channel.

p. Upon removal of the structure, the stream bank shall immediately be stabilized.

q. During routine road maintenance do not grade mud and debris over the sides of the crossing into the stream.

When the temporary structure has served its purpose, including bridge abutments or culverts and other bridging materials shall be removed and the disturbed area stabilized within 7 days. Care should be taken so that any aggregate left does not create an impediment to the flow or restrict fish passage.

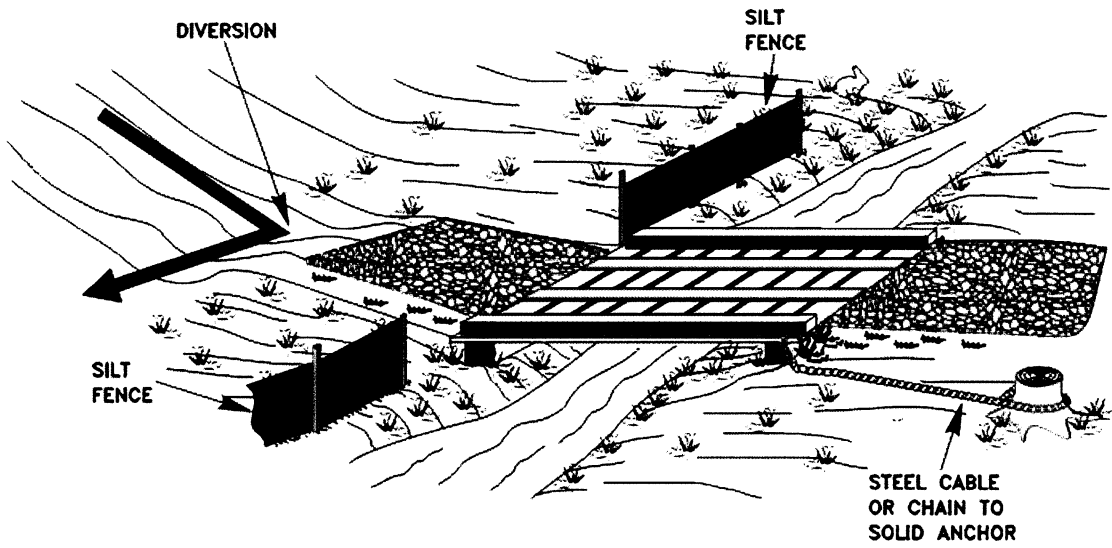
All construction materials shall be stored outside the waterway flood plain. Clean up shall be accomplished without construction equipment working in the stream channel.

**Maintenance**

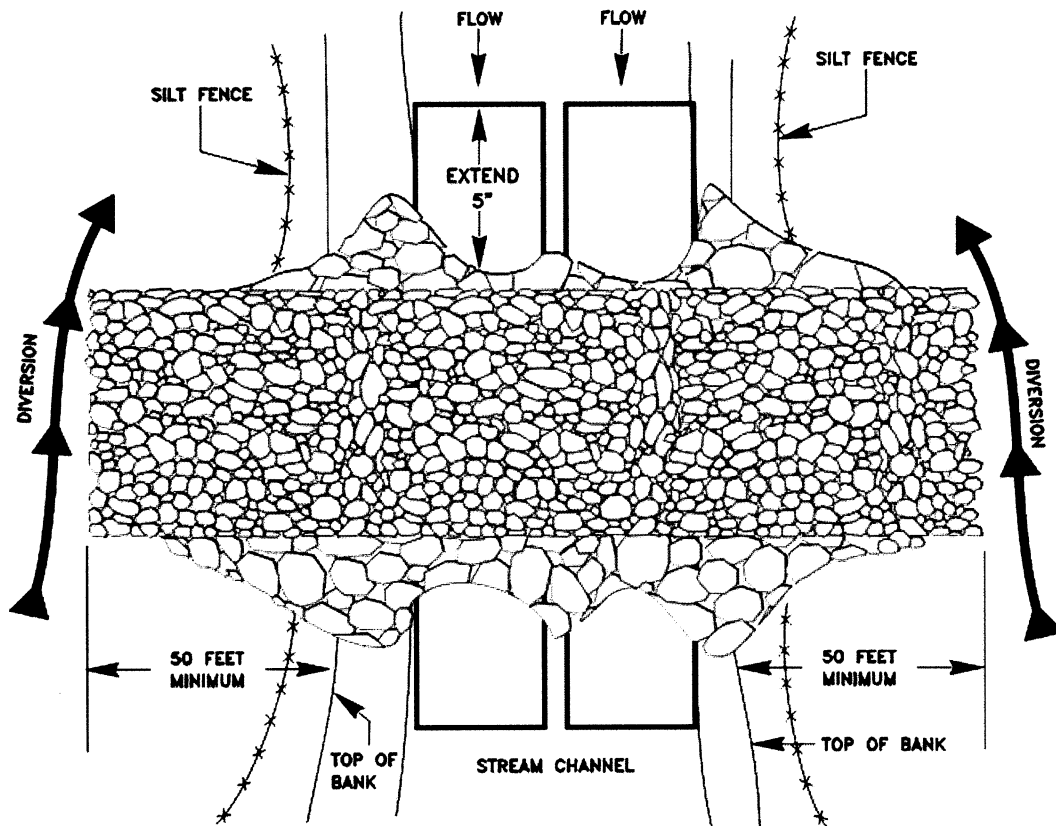
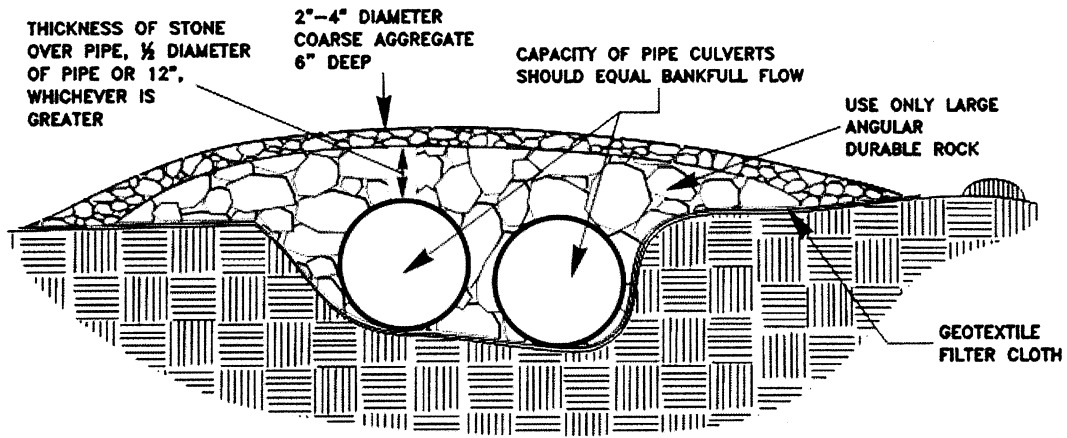
Periodic inspection must be performed to ensure that the bridge, culverts, streambed and stream banks are maintained and not damaged, that sediment is not entering the stream. At a minimum each crossing must be inspected after every rain event of 0.5 inches or more and once a week. Never allow the culverts to become clogged with debris. Remove any obstructions immediately.

Sediment and debris removed shall be disposed of outside of the flood plain and stabilized.

# TEMPORARY BRIDGE CROSSING



# CULVERT STREAM CROSSING



FROM: VA DSWC

# MINIMUM STANDARDS FOR INSTREAM CONSTRUCTION ACTIVITIES

---

## **General Requirements for all instream activities**

1. All appropriate permits should be obtained prior to beginning instream construction activities such as construction activities such as creating a restriction or impediment of flow. See the Regulatory Requirements section of this manual.
6. Isolating the work area and "working in the dry" is the only effective way of controlling sediment.
7. All instream construction should be scheduled to occur during low flow periods, typically during the summer and fall months. If construction must be accomplished during higher flows, the work area must be isolated from the stream by a structural measure such as a non-erodible cofferdam or sheet piling. Emergency repairs of public utilities or public roads are exempted.
8. All streambanks are to be stabilized with an appropriate protective material such as riprap, revegetation, geotextiles, revetments, etc. immediately upon completion of the final grading.
9. The choice of stabilization materials (vegetative or structural) should be based on sound engineering practices and will include investigations of the soil's erodibility and the anticipated velocities of the stream.
10. Inlet and outlet protection is required for all culverts (both temporary and permanent). Outlet protection can consist of riprap, gabion baskets, or other approved materials. See Outlet Protection section of this manual.
11. Every effort, in both planning and construction, should be made to limit the amount of instream work. Utility lines should not be installed within the stream, with the exception of stream crossing, without irrefutable proof that alternate avenues of alignment are not available. Convenience is not a justifiable reason to install a utility line down a stream.
12. Utility lines and roadways should cross the stream at right angles ( $\pm 15^\circ$ ) to the flow of the water.
13. Each stream crossing should be treated as a separate project and work should progress until the approaches and stream banks are completely stabilized. In no case should stabilization of the stream bank exceed 24 hours from completion of the backfill.
14. Streamside vegetation should be left intact to the greatest extent possible. Riparian buffer zones are to be enhanced whenever possible.
15. The sequence of construction events for the each instream activity should be included in the sediment control plan.

16. When a stream crossing is being constructed for vehicles, the crossing should be constructed as detailed in vehicle stream crossing section of this manual.
17. When work is performed in a flowing stream, precautions should be taken to minimize encroachment, control sediment transport and stabilize the work area to the greatest extent possible during construction. Use only non-erodible material for the construction of causeways, stream diversions and berms and cofferdams. Earthen fill may be used for cofferdams if armored by non-erodible cover materials such as filter fabric and appropriately sized stone.
18. All water pumped from a work area along, in or near a stream must be treated in an approved settling structure located outside the waterway before being discharged into a waterway. See DEWATERING section of this manual.
19. Green concrete is toxic to aquatic life and must not be placed in contact with flowing water.
20. Streambed excavation should be undertaken from the top of stream banks whenever possible.
21. When instream work is required, the use of rubber-tired vehicles and excavators is recommended.
22. Excavated material to be reused for trench backfill should be stockpiled outside the stream channel. Surround the storage area by silt fence or similar barrier to prevent sediment and mud from running back into the stream. Material not used for backfill should be removed to an appropriate soil disposal area located outside the floodplain and properly stabilized.
23. Temporary access roads in close proximity to a stream should be stabilized using the same requirements for a Stabilized Construction Entrance.
24. Do not use the stream as a vehicular right-of-way. Do not use the stream to deliver materials or to move construction equipment from one section to another.
25. Spill containment kits should be readily available onsite.



## 3.22 - DEWATERING

---

### ***Definition***

Dewatering refers to the act of removing and discharging water from excavated areas on construction sites, utility line construction or from sediment traps or basins on construction sites.

Given the unique conditions at any particular construction site, any or all of the practices may apply. In all cases, every effort shall be made to eliminate sediment pollution associated with dewatering.

### ***Practices for Dewatering Excavated Areas***

1. Pumping of water to an existing sediment basin or trap in which the entire volume of water from the area to be dewatered can be contained without discharge to receiving waters.
2. Pumping of water to an existing sediment basin or trap such that the entire volume of water from the area to be dewatered can be managed without exceeding the design outflow from the sediment control structure.
3. Use of a straw bale/silt fence pit or trap as shown in the drawings.
4. Pumping water through a geotextile bag made specifically for this purpose.
5. A well-vegetative Filter Strip, capable of withstanding the velocity of discharged water without eroding. Install some sort of energy dissipation (haybales, riprap or sheet of plywood) at the pump discharge.
6. Use a sump pit as shown on drawings to reduce the pumping mud.

### ***Dewatering of Sediment Traps and Basins***

Designers shall specify on plans, in the sequences of events and in the the practices for dewatering of traps and basins. In all cases, water removed from traps and basins shall be discharged so that it passes through a sediment control device prior to entering receiving waters.

### ***Practices for Dewatering of Traps and Basins***

1. Use of a straw bale/silt fence pit or trap as shown in the drawings.
2. Pumping water through a geotextile bag made specifically for this purpose.
3. A well-vegetative Filter Strip, capable of withstanding the velocity of discharged water without eroding. Install some sort of energy dissipation (haybales, riprap or sheet of plywood) at the pump discharge.
4. Regardless of the type of treatment always use a floating suction hose to pump the cleaner water from the top of the pond. As the cleaner water is pumped, the suction hose will lower and

eventually encounter sediment-laden water. At this point cease pumping operations and remove the remainder of the trapped sediment with machinery. Even when pumping from the top of the water column, provisions must still be made to filter water as required in this section prior to discharging to a stream. During the dewatering, personnel should be assigned to monitor pumping operations at all times to ensure that sediment pollution is abated. Pumping sediment-laden water into the waters of the State without filtration is prohibited.

***Design Criteria***

1. The dewatering device must be sized (and operated) to allow pumped water to flow through the filtering apparatus without exceeding the capacity of the structure. The following formula can be used to determine the storage volume for dewatering structures:  
  
Pump discharge (g.p.m.) x 16 = cubic feet of storage required
2. Material from any required excavation shall be stored in an area and protected in a manner that will prevent sediments from eroding and moving off-site.
3. An excavated basin (applicable to "Straw Bale/Silt Fence Pit") may be lined with filter fabric to help reduce scour and to prevent erosion of soil from within the structure. It may also be helpful to direct the discharge onto a hay or straw bale or riprap.
4. Design criteria more specific to each particular dewatering device can be found in the drawings.

***Construction Methods***

**Straw Bale/Silt Fence Pit**

- a. Measure shall consist of straw bales, silt fence, a stone outlet consisting of a combination of 4-8 inch riprap and ½ to 2 inch aggregate and a wet storage pit oriented as shown in drawing.
- b. The excavated area should be a minimum of 3 feet below the base of the perimeter measures (straw bales or silt fence).
- c. Once the water level nears the crest of the stone weir (emergency overflow), the pump must be shut off while the structure drains down to the elevation of the wet storage.
- d. The wet storage pit may be dewatered only after a minimum of 6 hours of sediment settling time. This effluent should be pumped across a well-vegetated area or through a silt fence prior to entering a watercourse.
- e. Once the device has been removed, ground contours will be returned to original condition.

### **Geotextile Filter Bag**

- a. The bag shall be installed on a very slight slope so incoming water flows downhill through the bag without creating more erosion.
- b. The neck of the Filter Bag shall be tightly strapped (minimum two straps) to the discharge hose.
- c. The bag should be placed on an aggregate or hay bale bed to maximize water flow through the entire surface area of the bag.
- d. The Filter Bag is full when it no longer can efficiently filter sediment or pass water at a reasonable rate.
- e. Flow rates vary depending on the size of the Dewatering Device, amount of sediment discharged into the Dewatering Device, the type of ground, rock, or other substance under the bag and the degree of the slope on which the bag lies. The Filter Bag should be sized to accommodate the anticipated flow rates from the type of pump used. Typically Filter Bags can handle flow rates of up to 1000 gallons per minute, but in all cases follow the manufacturers recommendations for flow rates.
- f. Use of excessive flow rates or overfilling the Dewatering Device with sediment will cause ruptures of the bag or failure of the hose attachment straps.
- g. The Filter Bag can be left in place after cutting the top off and seeding and mulching the accumulated sediment or removed and disposed of offsite in an approved landfill.
- h. Each standard Dewatering Device shall have a fill spout large enough to accommodate the discharge hose. Use two stainless steel straps to secure the hose and prevent pumped water from escaping without being filtered.
- i. The Dewatering Device shall be a nonwoven bag, which is sewn with a double needle stitching using a high strength thread.
- j. The Dewatering Device seams shall have an average wide width strength per ASTM D 4884 of 100 LB/IN (1.15 kg/meter).
- k. The geotextile fabric shall be a nonwoven fabric with the following properties:

**Table 3.22.1 GEOTEXTILE FABRIC PROPERTIES**

Properties	Test Method	English	Metric
Grab Tensile	ASTM D-4632	250 Lbs.	113 kg
Puncture	ASTM D-4833	165 Lbs.	75 kg
Flow Rate	ASTM D-4491	70 Gal/Min/ Square Foot	25 liters/Min/ Square Meter
Permittivity	ASTM D-4491	1.3 Sec.-1	1.3 Sec.-1
Mullen Burst	ASTM D-3786	550 Lbs./ Square inch	3.79 MPa
UV Resistant	ASTM D-4355	70%	70%
AOS % Retained	ASTM D-4751	100%	100%

\*All properties are minimum average roll value.

***Maintenance***

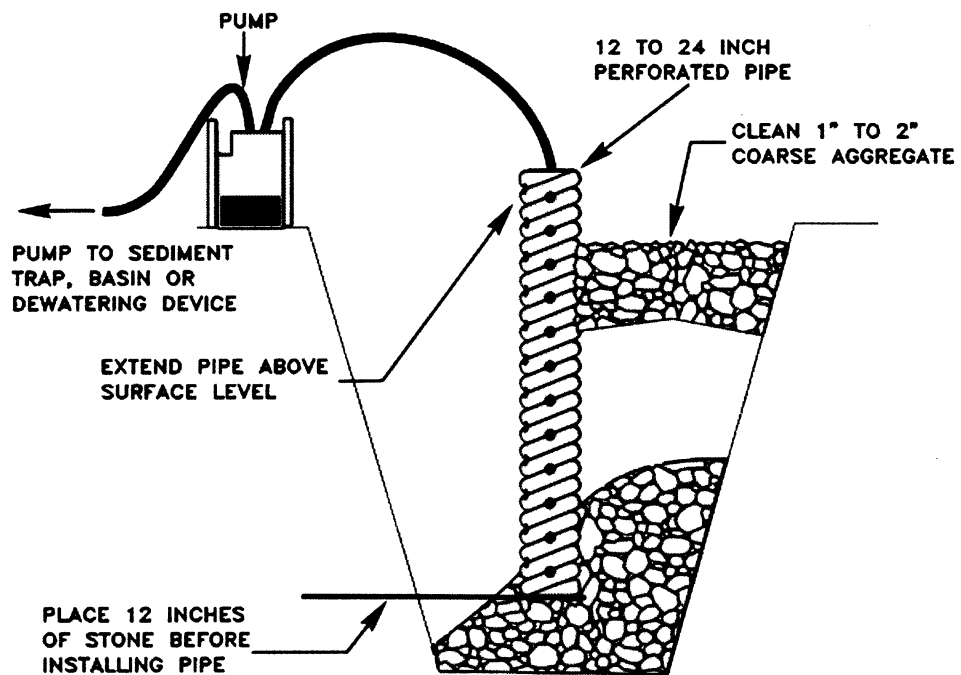
The filtering devices must be inspected frequently during pumping operations and repaired or replaced once the sediment build-up prevents the structure from functioning as designed.

Once the wet storage area becomes filled with sediment to one-half of the excavated depth, accumulated sediment shall be removed and disposed of properly.

The accumulated sediment that is removed from a dewatering device must be spread on-site and stabilized or disposed of at an approved disposal site as per approved plan.

FIGURE 3.22-1

# SUMP PIT



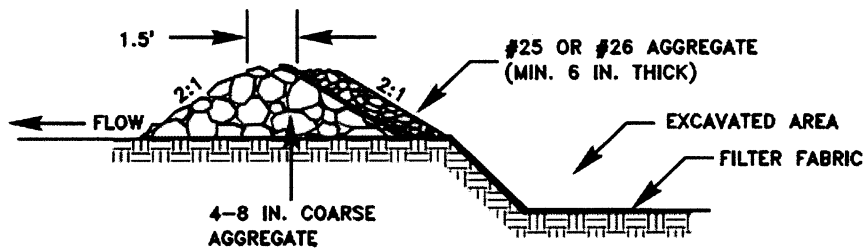
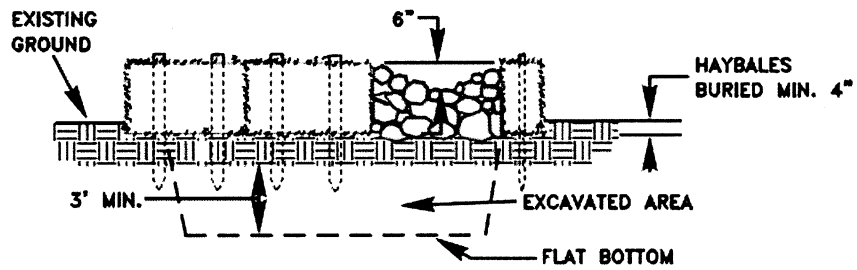
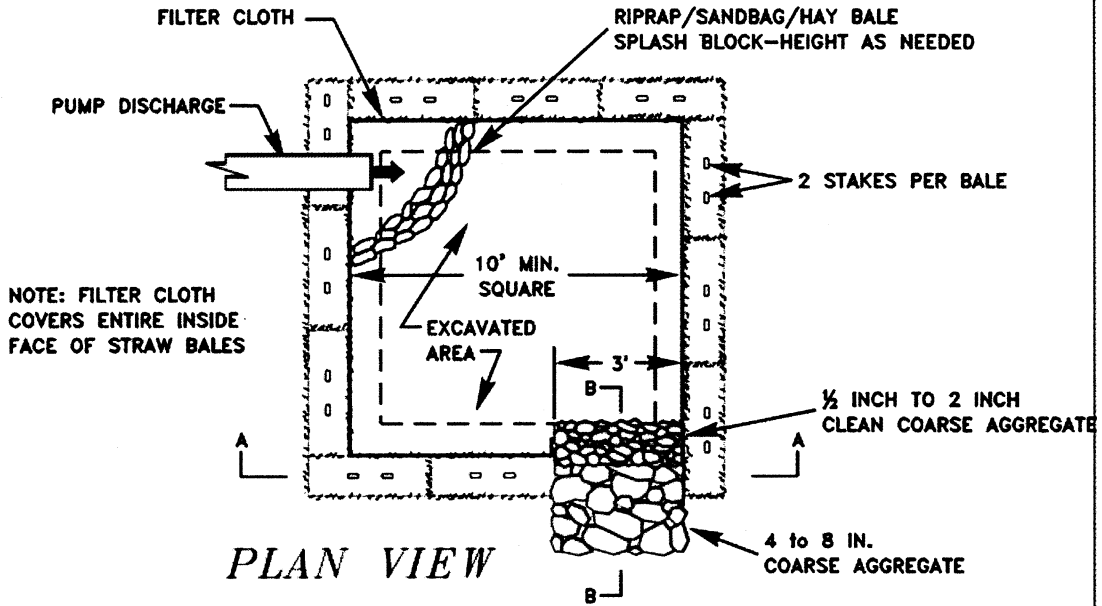
FROM NEW YORK DEC

3.22-5

3.22-5

FIGURE 3.22-2

# STRAW BALE/SILT FENCE PIT



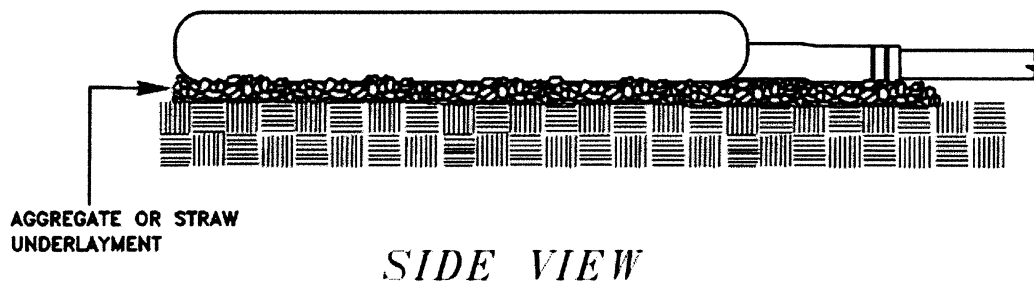
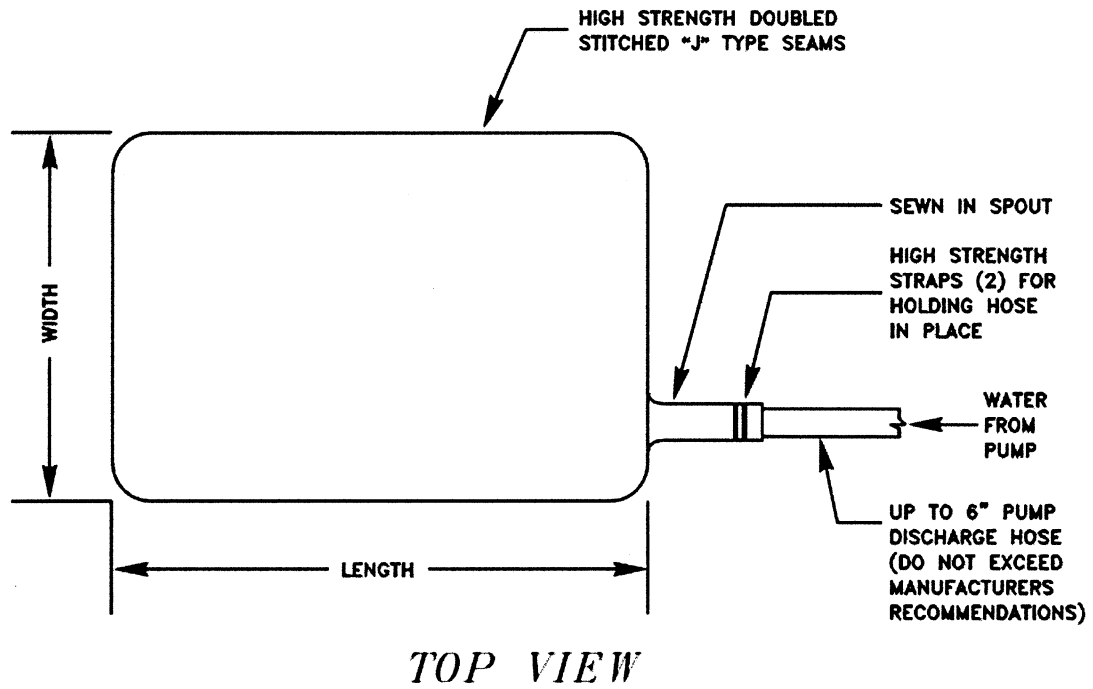
SOURCE: Va. DSWC

3.22-6

3.22-6

FIGURE 3.22-3

# DEWATERING BAG

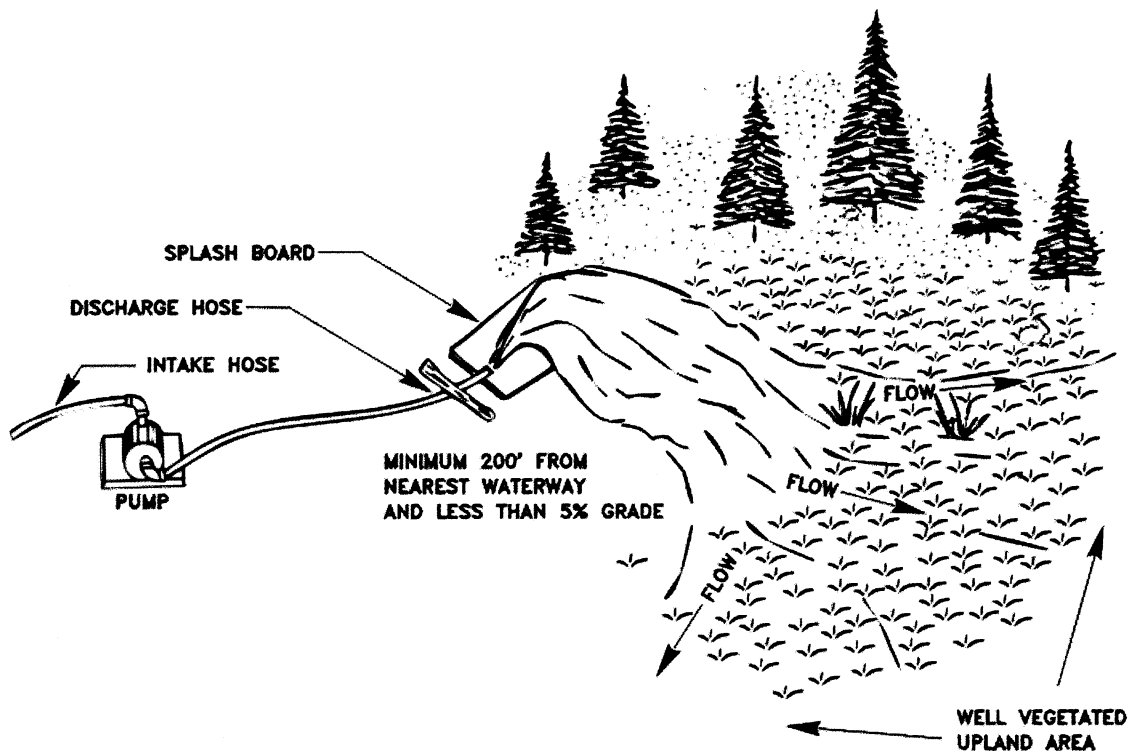


3.22-7

3.22-7

FIGURE 3.22-4

## DEWATERING DISCHARGE IN UPLAND AREA WITH ADEQUATE VEGETATION



FROM: CNG TRANSMISSION CORP.

3.22-8



## 3.23 - RIPRAP

---

### ***Introduction***

A permanent, erosion-resistant ground cover of large, loose, angular stone with filter fabric or granular underlining used to protect the soil from:

1. The erosive forces of concentrated runoff.
2. To slow the velocity of concentrated runoff while enhancing the potential for infiltration.
3. To stabilize slopes with seepage problems and/or non-cohesive soils.

### ***Conditions Where Practice Applies***

Wherever soil and water interface and the soil conditions, water turbulence and velocity, expected vegetative cover, etc., are such that the soil may erode under the design flow conditions. Riprap may be used, as appropriate, at storm drain outlets, on channel banks and/or bottoms, roadside ditches, drop structures, at the toe of slopes, as transition from concrete channels to vegetated channels, etc.

### ***Planning.***

Riprap is classified as either graded or uniform. A sample of graded riprap would contain a mixture of stones that vary in size from small to large. A sample of uniform riprap would contain stones which are all fairly close in size. For most applications, graded riprap is preferred to uniform riprap. Graded riprap forms a flexible self-healing cover, while uniform riprap is more rigid and cannot withstand movement of the stones. Graded riprap is cheaper to install, requiring only that the stones be dumped so that they remain in a well-graded mass. Hand or mechanical placement of individual stones is limited to that necessary to achieve the proper thickness, line and grade. Uniform riprap requires placement in a more or less uniform pattern, requiring more hand or mechanical labor.

Riprap sizes can be designed by either the diameter or the weight of the stones. The weight of the stone is the more significant design parameter but it is simpler to specify the diameter of the stone. The correlation between stone size and weight is typically based upon an assumed specific weight of 165 lbs./ft<sup>3</sup>.

Since graded riprap consists of a variety of stone sizes, a method is needed to specify the size range of the mixture of stone. This is done by specifying a diameter of stone in the mixture for which some percentage, will be smaller. For example, d85 refers to a mixture of stones in which 85% of the stone would be smaller than the diameter specified. Most designs are based on d50. In other words, the design is based on the median size of stone in the mixture, where 50% will be larger than the

d50 and 50% will be smaller. It is also necessary to give the upper and lower limits for the stone size too.

To ensure that stone of substantial weight is used when constructing riprap structures, specified weight and diameter ranges for individual stones and composition requirements should be followed. Such guidelines will help to prevent inadequate stone from being used in construction of the measures and will promote more consistent stone classification statewide. Table 3.23.1 notes these requirements.

**Table 3.23.1 AASHTO RIPRAP GRADATION CLASSES**

Riprap Class	Rock Size <sup>1</sup> feet (mm)		Rock Size <sup>2</sup> pounds (kg)		Percent of Riprap Smaller Than
A	1.30	(400)	200	(90)	100
	0.95	(290)	75	(35)	50
	0.40	(120)	5	(2)	10
B	1.80	(550)	500	(225)	100
	1.30	(400)	200	(90)	50
	0.40	(120)	5	(2)	10
C	2.25	(690)	1000	(455)	100
	1.80	(550)	500	(225)	50
	0.95	(290)	75	(35)	10
D	2.85	(870)	2000	(910)	100
	2.25	(690)	1000	(455)	50
	1.80	(550)	500	(225)	5
E	3.60	(1100)	4000	(1815)	100
	2.85	(870)	2000	(910)	50
	2.25	(690)	1000	(455)	5
F	4.50	(1370)	8000	(3630)	100
	3.60	(1100)	4000	(1815)	50
	2.85	(870)	2000	(910)	5

1 Assuming a specific gravity of 2.65.

2 Based on AASHTO gradations.

In practice though it is hard to acquire stones of the desired size. Quarries normally sell a narrower range of riprap sizes and in ranges incompatible with the above chart. The typical range of riprap available in West Virginia will be 4"-8" (gabion stone per DOH specifications), 6"-12", 10"-24", and 12"-36". Many times the contractor will crush their own stone on site.

If stone is crushed on site great care must be taken to produce stone sizes that mirror the requirements created by the designer and this specification. The most common problem is generating stone that is much too large and in a range of sizes that does not meet the gradation requirements.

Oversize stones, even in isolated spots, may cause riprap failure by precluding mutual support between individual stones, providing large

voids that expose filter and bedding materials, and creating excessive local turbulence that removes smaller stones. Small amounts of oversize stone should be removed individually and replaced with proper size stones.

When excessively large stone is used for channel lining there is an increased chance of erosion underneath the rock, which can cause a total failure of the channel. During higher flows the runoff must travel across the top of the riprap, not underneath. This point cannot be stressed enough. Bigger is not better when it comes to rock for channel lining.

### **Sequence of Construction**

Since riprap is used where erosion potential is high, construction must be sequenced so that the riprap is put in place as quickly as possible.

Disturbance of areas where riprap is to be placed should be undertaken only when final preparation and placement of the riprap can follow immediately behind the initial disturbance. Where riprap is used for outlet protection, the riprap should be installed before the construction of the pipe or channel is completed.

### ***Design Criteria***

**Gradation**-The riprap shall be composed of a well-graded mixture down to the 1-inch size particle such that 50% of the mixture by weight shall be larger than the d50 size as determined from the design procedure. A well-graded mixture as used herein is defined as a mixture composed primarily of the larger stone sizes but with a sufficient mixture of other sizes to fill the progressively smaller voids between the stones. The diameter of the largest stone size in such a mixture shall be 1.5 times the d50 size.

The designer, after determining the riprap size that will be stable under the flow conditions, should consider that size to be a minimum size and then, based on riprap gradations actually available in the area, select the size or sizes that equal or exceed the minimum size. The possibility of damage by children shall be considered in selecting a riprap size, especially if there is nearby water or a gully in which to toss the stones.

**Thickness**-The minimum thickness of the riprap layer shall be 2 times the maximum stone diameter, but not less than 6 inches.

**Quality of Stone**-Stone for riprap shall consist of fieldstone or rough unhewn quarry stone of approximately rectangular shape. The stone shall be hard and angular and of such quality that it will not disintegrate on exposure to water or weathering and it shall be suitable in all respects for

the purpose intended. The specific gravity of the individual stones shall be at least 2.5.

Rubble concrete may be used provided it has a density of at least 165 pounds per cubic foot, and other wise meets the requirements of this BMP. All rebar shall be removed flush with the surface of the concrete.

**Filter Fabric Underlining**--A lining of engineering filter fabric (geotextile) shall be placed between the riprap and the underlying soil surface to prevent soil movement into or through the riprap. GEOTEXTILE has the minimum physical properties of the filter fabric.

Filter fabric shall not be used on slopes greater than 1.5:1 as slippage may occur and should be used in conjunction with a layer of coarse aggregate (granular filter blanket is described below) when the riprap to be placed is Class C or larger.

**Granular Filter**--Although the filter cloth underlining or bedding is the preferred method of installation, a granular (stone) bedding is a viable option when the following relationship exists:

$$\frac{d_{15} \text{ filter}}{d_{85} \text{ base}} < 5 < \frac{d_{15} \text{ filter}}{d_{15} \text{ base}} < 40$$

*and*

$$\frac{d_{50} \text{ filter}}{d_{50} \text{ base}} < 40$$

In these relationships, filter refers to the overlying material and base refers to the underlying material. The relationships must hold between the filter material and the base material and between the riprap and the filter material. In some cases, more than one layer of filter material may be needed. Each layer of filter material should be approximately 6-inches thick.

### **Riprap at Outlets-**

Design criteria for sizing the stone and determining the dimensions of riprap pads used at the outlet of drainage structure are contained in OUTLET PROTECTION. A filter fabric underlining is required for riprap used as outlet protection.

### **Riprap for Channel Stabilization**

Riprap for channel stabilization shall be designed to be stable for the condition of bankfull flow in the reach of channel being stabilized. This method establishes the stability of the rock material relative to the forces exerted upon it. (see Figure 3.21.7)

Riprap shall extend up the banks of the channel to a height equal to the maximum depth of flow or to a point where vegetation can be established to adequately protect the channel.

The riprap size to be used in a channel bend shall extend upstream from the point of curvature and downstream from the bottom of the channel to a minimum depth equal to the thickness of the blanket and shall extend across the bottom of the channel the same distance.

**Freeboard and Height of Bank**

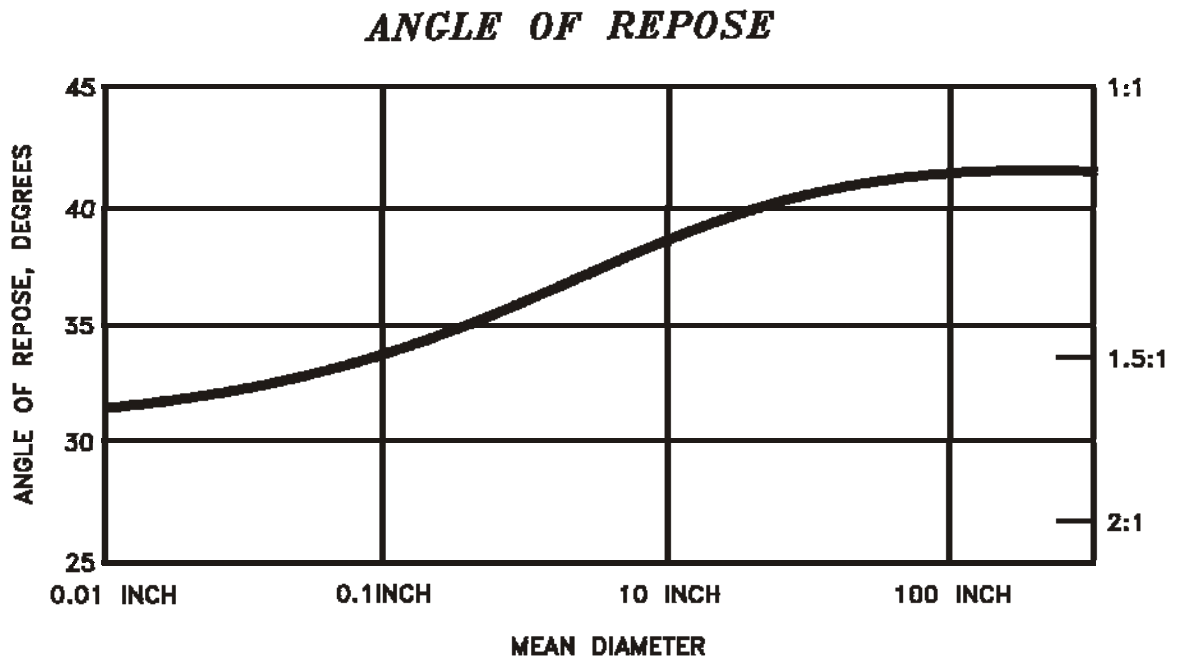
For riprapped and other lined channels, the height of channel lining above the water surface should be based on the size of the channel, the flow velocity, the curvature, inflows, wind action, flow regulation, etc. This manual does not provide the design for riprap revetment. The Federal Highway Administration in HEC-11 provides the necessary information to design riprap streambank protection.

The height of the bank above the water surface varies in a similar manner, depending on the above factors plus the type of soil.

**Riprap for Slope Stabilization**

Riprap for slope stabilization shall be designed so that the natural angle of repose of the stone mixture is greater than the gradient of the slope being stabilized (see Figure 3.23.1).

**Figure 3.23.1 ANGLE OF REPOSE**



## **Construction Specifications**

**Subgrade Preparation:** The subgrade for the riprap or filter shall be prepared to the required lines and grades. Any fill required in the subgrade shall be compacted to a density approximately that of the surrounding undisturbed material. Brush, trees, stumps and other objectionable material shall be removed.

**Filter Fabric or Granular Filter:** Placement of the filter fabric should be done immediately after slope preparation. For granular filters, the stone should be spread in a uniform layer to the specified depth, normally 6 inches. Where more than one- layer of filter material is used, the layer should be spread so that there is minimal mixing of the layers.

When installing geotextile filter cloths, the cloth should be placed directly on the prepared slope. The edges of the sheets should overlap by at least 12 inches. Anchor pins, 15 inches long, should be spaced every 3 feet along the overlap. The upper and lower ends of the cloth should be buried at least 12 inches. Care should be taken not to damage the cloth when placing the riprap. If damage occurs, that sheet should be removed and replaced. For large stone (Class C or greater), a 6-inch layer of granular filter will be necessary to prevent damage to the cloth.

**Stone Placement:** Placement of riprap should follow immediately after placement of the filter. The riprap should be placed so that it produces a dense well-graded mass of stone with a minimum of voids. The desired distribution of stones throughout the mass may be obtained by selective loading at the quarry, controlled dumping of successive loads during final placing, or by a combination of these methods.

The riprap should be placed to its full thickness in one operation. The riprap should not be placed in layers. The riprap should not be placed by dumping into chutes or similar methods that are likely to cause segregation of the various stone sizes.

Blend the stone surface smoothly with the surrounding area, allowing no protrusions, overfall or in the case of channels so the stone does not form a dam to incoming runoff.

Care should also be taken not to dislodge the underlying material when placing the stones.

The finished slope must be free of pockets of small stone or clusters of large stones.

Hand placing may be necessary to achieve the required grades and a good distribution of stone sizes. Final thickness of the riprap blanket should be within plus or minus 1/4 of the specified thickness.

### **Common Installation Problems**

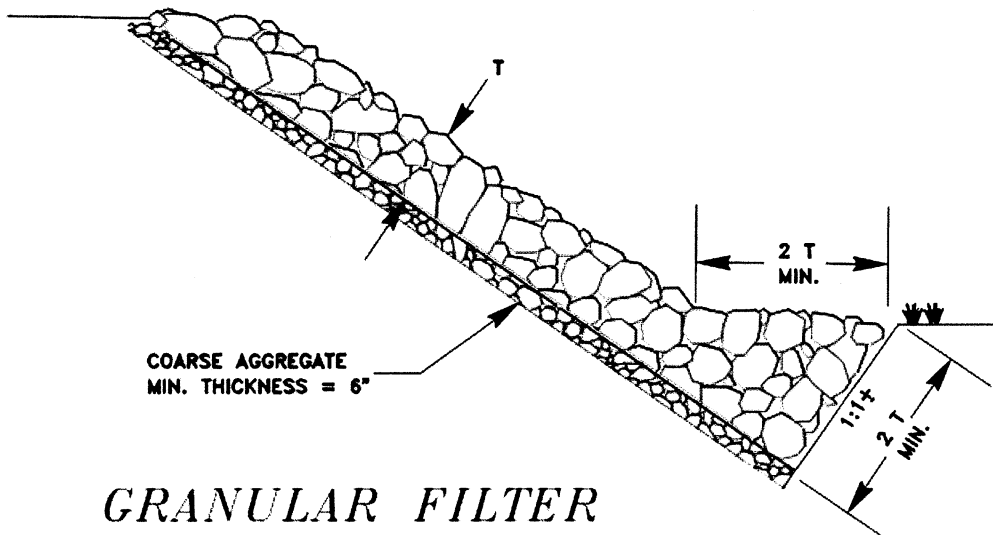
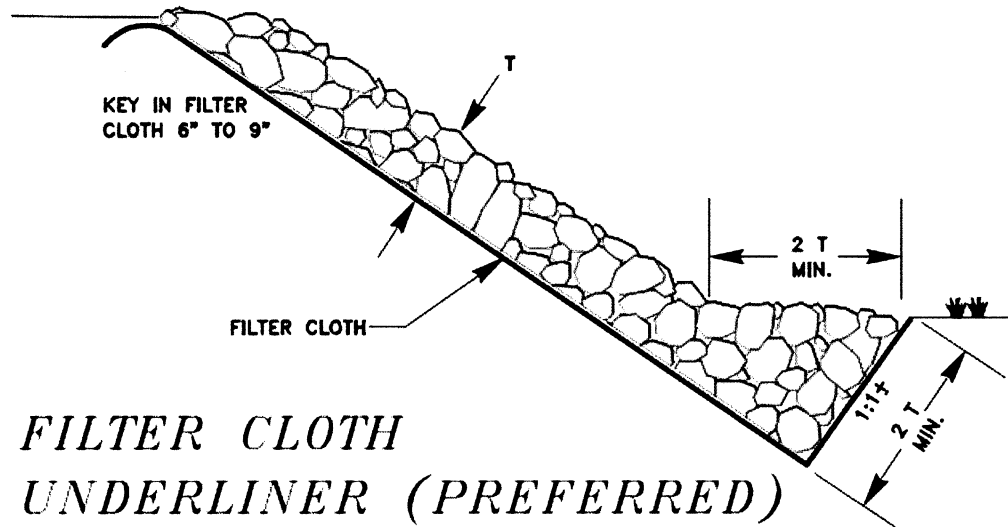
- Channel not excavated deep enough to accept the design thickness of the stone. Riprap blocks channel, resulting in erosion along edges.
- Stone too large resulting in water eroding underneath and undermining the stone.
- Slope too steep: Results in stone displacement. Do not use riprap as a retaining wall.
- Foundation not properly smoothed for filter placement: Results in damage to filter.
- Filter omitted or damaged: Results in piping or slumping.
- Riprap not properly graded: Results in stone movement and undermining and erosion of foundation.
- Foundation toe not properly reinforced: Results in undercut riprap slope or slumping.
- Fill slopes not properly compacted before placing riprap: Results in stone displacement.

### ***Maintenance***

Once a riprap installation has been completed, it should require very little maintenance. It should, however, be inspected periodically to determine if high flows have caused scour beneath the riprap or filter fabric or dislodged any of the stone. Care must be taken to properly control sediment-laden construction runoff that may drain to the point of the new installation. If repairs are needed, they should be accomplished immediately.

FIGURE 3.23.2

## TOE REQUIREMENTS FOR BANK STABILIZATION



SOURCE: Adapted from VDOT Drainage Manual



## 3.24 - GEOTEXTILES

---

### ***Introduction***

Geotextiles are any permeable textile fabric used to increase soil stability, provide erosion control or aid in drainage. Geotextiles are usually made from a synthetic polymer such as polypropylene, polyester, polyethylenes and polyamides. Geotextiles can be woven, knitted or non-woven.

### ***Conditions Where Practice Applies***

Geotextiles come in a tremendous variety and are used in many situations on a construction site. Geotextiles usage falls into four broad categories, three of which are important to sediment and erosion control. These three categories are separation, reinforcement and filtration. The fourth type is as an impervious barrier. Each subcategory of geotextile is designed to perform a specific function. To select the right product, it is important to understand the product's functions and the physical characteristics needed to meet those functions.

**Separation-** It is sometimes necessary to maintain a physical separation between two dissimilar materials to maximize the physical attributes of each of those materials. For example, in drainage systems, it is necessary to prevent fine soils from filling the voids in a rock base; otherwise, the drainage system becomes clogged and ineffective over time. Yet, it is important to allow water to pass between the soil and the drainage system.

In other applications, it is desirable to prevent any water from coming into contact with the soil, so an impervious separation surface is required. The selection of an appropriate product to achieve a physical separation is determined, therefore, by the desired outcome.

**Reinforcement-** The physical characteristics of soils, especially on slopes resulting from cuts and fill activities, can create unstable conditions. Geotextiles can help strengthen the soil face and increase the soil's ability to remain in place. Slopes can be stabilized either temporarily or permanently, slowing or preventing creep or slips. Also, geotextiles can be used either to prevent water from permeating a slope or to control the amount of infiltration that occurs during rainfall.

Geotextiles are especially useful in reinforcing inadequate subsoil when building roads, parking areas and paths. When soil conditions are weak, adding an appropriate geotextile can create a three-dimensional surface that will withstand heavier vehicles.

**Filtration-** The filtration aspect of geotextiles was understood early on by the originator of silt fence as a sediment control device. Where the flows are minimal, a geotextile can be placed across the contour to create a dam and settle out the suspended solids contained in the runoff. While not technically a filter, the geotextile's openings serve as the outlet

necessary to pass water through the dam and filter out soil particles that are in suspension. Finer particles can pass through the fabric, so the size of the particles, the flow rate of the water and the physical location of the filter will determine the type of fabric that is appropriate.

For most geotextile applications relating to the construction industry, the American Association of State Highway and Transportation Officials (AASHTO) has developed guidelines. These guidelines provide classifications that are primarily based on the mechanical stresses the geotextile would be subjected to during installation. Typically, the stresses borne by geotextiles are highest during the installation of the fabric and placement of the cover material. The charts in this section are based on these AASHTO guidelines but come from the city of Seattle.

Geotextiles are either woven or non-woven.

**Woven-** Typically, woven fabric provides higher strengths. Weaving two or more strands of synthetic yarn at right angles produces woven fabrics. The yarn typically comes in two shapes: round and flat. Flat, also called slit film, is used where high strength is required but filtration is not. Round, or monofilament fabric, provides both high strength and filtration.

Woven stabilization fabrics provide the strength and separation needed for paved or unpaved road applications. High tensile strength and low elongation reduces rutting in both paved and unpaved surfaces. The fabrics separate the base course while reinforcing the adjacent soft soil.

Woven fabric is also used for silt fence and super silt fence. Geotextiles used for these practices must have the porosity and strength to withstand and pass through water as well as ultraviolet light inhibitors to protect it from the sun.

**Non-woven-** Non-woven fabric resembles felt and can provide planar water flow when used in subsurface drains, asphalt pavement overlays and erosion control. Higher weight non-woven fabric can be also used for separation under aggregate.

Non-woven fabric, slit films and combination fabrics have little open area, and often trap soil particles with the thickness of the fabric, clogging the geotextile.

Care must be taken to choose the appropriate fabric for the existing conditions, and, as with all commercial products, follow the manufacturer's recommendations.

Other design considerations are the porosity of the fabric, permittivity, tensile strength, elongation, Mullen burst, puncture strength, AOS (average opening size), seam strength and resistance to ultraviolet radiation. Each use will have a unique set of requirements that need to be taken into consideration.

## **ASSHTO M288 Classifications**

M288-96 is based on geotextile survivability from installation stresses. Selection of the geotextile is based on knowledge of the anticipated exposure to installation stresses. M288-96 covers six geotextile applications: subsurface drainage, separation, stabilization, permanent erosion control, temporary silt fences and paving fabrics.

In M288-92, geotextile survivability was divided into classes A and B. Class A was used where installation stresses determined by aggregate shape, trench depth, and the size and height of an armor stone drop were more severe than in Class B installations. There are no definitive measurements set for differentiating between severe and less severe installation stresses.

In M288-96, the general strength requirements for the subsurface drainage, separation, stabilization and permanent erosion control applications are broken into three classes of geotextiles. Class 1 represents the most robust and Class 3 the least. Within each survivability class, the strength requirements are established based on elongation at break in the grab strength test. The highest strength requirement is for materials that break at less than 50 percent elongation (typically woven) and the least for those that break at greater than 50 percent elongation (typically unwoven). The requirements for the silt-fence applications are based on supported or unsupported fences. Paving fabrics are limited to fabrics with elongation at break of greater than 50 percent.

AASHTO Specification M288-96 for geotextiles is published in the two volume Standard Specifications for Transportation Materials and Methods of Sampling and Testing, 18th Ed.

### ***Design Considerations***

In order to choose the appropriate geotextile, a proper evaluation of the proposed use, material specification and installation procedure is required. Since using geotextiles for stabilization of soils involves four basic functions, reinforcement, separation, filtration and drainage, it is important to be familiar with both the site conditions where the fabric will be installed and the various properties of geotextiles. The local soil characteristics and groundwater are two of the more important considerations to be considered. And since fabric strength calculations are based primarily on installation stresses, the type and size of the aggregate to be used is also important. Therefore there are a number of factors that will need to be considered when specifying fabrics.

### Geotextile and thread for sewing

The material shall be a geotextile consisting only of long chain polymeric fibers or yarns formed into a stable network such that the fibers or yarns retain their position relative to each other during handling, placement and design service life. At least 95 percent by weight of the material shall be polyolefins or polyesters. The material shall be free from defects or tears. The geotextile shall also be free of any treatment or coating which might adversely alter its hydraulic or physical properties after installation. The geotextile shall conform to the properties as indicated in Tables 3.24.2 through 3.24.7 for each use specified.

Thread used for sewing shall consist of high strength polypropylene, polyester or polyamide. Nylon threads will not be allowed. The thread used to sew permanent erosion control geotextiles shall be resistant to ultraviolet radiation. The thread shall be of contrasting color to that of the geotextile itself.

The geotextile uses included in this section and their associated tables of properties are as follows:

**Table 3.24.1 List of geotextile tables**

<b>Geotextile application</b>	<b>Applicable property tables</b>
Underground drainage, low survivability, Classes A, B, and C	Tables 3.24.2 and 3.24.3
Underground drainage, moderate survivability, Classes A, B, and C	Tables 3.24.2 and 3.24.3
Separation	Table 3.24.4
Soil stabilization	Table 3.24.4
Permanent erosion control, moderate survivability, Classes A, B, and C	Tables 3.24.5 and 3.24.6
Permanent erosion control, high survivability, Classes A, B, and C	Tables 3.24.5 and 3.24.6
Ditch lining	Table 3.24.5
Temporary silt fence	Table 3.24.7

**Table 3.24.2 Geotextile for underground drainage strength properties for survivability**

		Geotextile property requirements <sup>1</sup>	
Geotextile property	Test method <sup>2</sup>	Low survivability woven/non-woven	Moderate survivability woven / non-woven
Grab tensile strength, min. in machine and x-machine direction	ASTM D 4632	180 lbs. / 115 lbs. min.,	250 lbs. / 160 lbs. min.
Grab failure strain, in machine and x-machine direction	ASTM D 4632	<50% // 50%	<50% // 50%
Seam breaking strength	ASTM D 4632 <sup>3</sup>	160 lbs. / 100 lbs. min.	220 lbs. / 140 lbs. min.
Puncture resistance	ASTM D 4833	67 lbs. / 40 lbs. min.	80 lbs. / 50 lbs. min.
Tear strength, min. in machine and x-machine direction	ASTM D 4533	67 lbs. / 40 lbs. min.	80 lbs. / 50 lbs. min.
Ultraviolet (UV) radiation stability	ASTM D 4355	50% strength retained min., after 500 hrs. in weatherometer	50% strength retained min., after 500 hrs. in weatherometer

See notes after Table 3.24.7, this specification.

**Table 3.24.3 Geotextile for underground drainage filtration properties**

		Geotextile property requirements <sup>1</sup>		
Geotextile property	Test method <sup>2</sup>	Class A	Class B	Class C
AOS	ASTM D 4751	.43 mm max. (No. 40 sieve)	.25 mm max. (No. 60 sieve)	.18 mm max. (No. 80 sieve)
Water permittivity	ASTM D 4491	.5 sec <sup>-1</sup> min.	.4 sec <sup>-1</sup> min.	.3 sec <sup>-1</sup> min.

See notes after Table 3.24.7, this specification.

**Table 3.24.4 Geotextile for separation or soil stabilization**

		<b>Geotextile property requirements<sup>1</sup></b>	
<b>Geotextile property</b>	<b>Test method<sup>2</sup></b>	<b>Separation woven/non-woven</b>	<b>Soil stabilization woven/non-woven</b>
AOS	ASTM D 4751	.60 mm max. (No. 30 sieve)	.43 mm max. (No. 40 sieve)
Water permittivity	ASTM D 4491	.02 sec-1 min.	.10 sec-1 min.
Grab tensile strength, min. in machine and x-machine direction	ASTM D 4632	250 lbs. / 160 lbs. min.	315 lbs./200 lbs. min.
Grab failure strain, in machine and x-machine direction	ASTM D 4632	<50% //50%	<50% //50%
Seam breaking strength	ASTM D 4632 <sup>3</sup>	220 lbs. / 140 lbs. min.	270 lbs./180 lbs. min.
Puncture resistance	ASTM D 4833	80 lbs. / 50 lbs. min.	112 lbs./79 lbs. min.
Tear strength, min. in machine and x-machine direction	ASTM D 4533	80 lbs. / 50 lbs. min.	112 lbs./79 lbs. min.
Ultraviolet (UV) radiation stability	ASTM D 4355	50% strength retained min., after 500 hrs. in weatherometer	50% strength retained min., after 500 hrs. in weatherometer

See notes after Table 3.24.7, this specification.

**Table 3.24.5 Geotextile for permanent erosion and ditch lining**

		Geotextile property requirements <sup>1</sup>		
		Permanent erosion control		Ditch lining
Geotextile property	Test method <sup>2</sup>	Moderate survivability woven / non-woven	High survivability woven / non-woven	Woven / non-woven
AOS	ASTM D 4751	See Table 3.24.6	See Table 3.24.6	.60 mm max (No. 30 sieve)
Water permittivity	ASTM D 4491	See Table 3.24.6	See Table 3.24.6	.02 sec <sup>-1</sup> min.
Grab tensile strength, min. in machine and x-machine direction	ASTM D 4632	250 lbs. / 160 lbs. min.	315 lbs. / 200 lbs. min.	250 lbs. / 160 lbs. min.
Grab failure strain, in machine and x-machine direction	ASTM D 4632	15% - 50% / > 50%	15% - 50% / > 50%	<50% / <sup>3</sup> 50%
Seam breaking strength	ASTM D 4632 <sup>3</sup>	220 lbs. / 140 lbs. min.	270 lbs. / 180 lbs. min.	220 lbs. / 140 lbs. min.
Burst strength	ASTM D 3786	400 psi / 190 psi min.	500 psi / 320 psi min.	-----
Puncture resistance	ASTM D 4833	80 lbs. / 50 lbs. min.	112 lbs. / 79 lbs. min.	80 lbs. / 50 lbs. min.
Tear strength, min. in machine and x-machine direction	ASTM D4533	80 lbs. / 50 lbs. min.	112 lbs. / 79 lbs. min.	80 lbs. / 50 lbs. min.
Ultraviolet (UV) radiation stability	ASTM D 4355	70% strength retained min., after 500 hrs. in weatherometer	70% strength retained min., after 500 hrs. in weatherometer	70% strength retained min., after 500 hrs. in weatherometer

See notes after Table 3.24.7, this specification.

**Table 3.24.6 Filtration properties for geotextile for permanent erosion control**

		Geotextile property requirements <sup>1</sup>		
Geotextile property	Test method <sup>2</sup>	Class A	Class B	Class C
AOS	ASTM D4751	0.43 mm max. (No.40 sieve)	0.25 mm max. (No.60 sieve)	0.22 mm max. (No. 70 sieve)
Water permittivity	ASTM D4491	0.7 sec <sup>-1</sup> min.	0.4 sec <sup>-1</sup> min.	0.2 sec <sup>-1</sup> min.

See notes after Table 3.24.7, this specification.

**Table 3.24.7 Geotextile for temporary silt fence**

		Geotextile property requirements <sup>1</sup>	
Geotextile property	Test method <sup>2</sup>	Unsupported between posts	Supported between posts with wire or polymeric mesh
AOS	ASTM D 4751	.60 mm max. for slit film wovens (No. 30 sieve) .30 mm max. for all other geotextile types (No. 50 sieve).15 mm min.(No. 100 sieve)	.60 mm max. for slit film wovens (No. 30 sieve).30 mm max. for all other geotextile types (No. 50 sieve).15 mm min. (No. 100 sieve)
Water permittivity	ASTM D 4491	.02 sec <sup>-1</sup> min.	.02 sec <sup>-1</sup> min.
Grab tensile strength, min. in machine and x-machine direction	ASTM D 4632	180 lbs. min. in machine direction, 100 lbs. min. in x-machine direction	100 lbs. min.
Grab failure strain, min. in machine direction only	ASTM D 4632	30% max. at 180 lbs. or more	-----
Ultraviolet (UV) radiation stability	ASTM D 4355	70% strength retained min., after 500 hrs. in weatherometer	70% strength retained min., after 500 hrs. in weatherometer

**Notes**

<sup>1</sup>All geotextile properties in Tables 1 through 6 are minimum average roll values (i.e., the test result for any sampled roll in a lot shall meet or exceed the values shown in the table).

<sup>2</sup>The test procedures used are essentially in conformance with the most recently approved ASTM geotextile test procedures, except for geotextile sampling and specimen conditioning, which are in accordance with WSDOT Test Methods 914 and 915, respectively.

<sup>3</sup>With seam located in the center of 8-inch long specimen oriented parallel to grip faces.

Source for tables: <http://www2.ci.seattle.wa.us/util/engineering/ArticleView.asp?ArticleID=9-05.22#9-05.22>



***Construction Specifications***

Since the greatest stresses occur during installation of the geotextile and overlying material, the following conditions should be met:

1. Ensure the ground surface is clear of stones, roots, and debris.
2. Provide a surface to lay the fabric on that is as smooth as possible and free of humps or holes.
3. Ensure that the geotextile is in intimate contact with the soil.
4. Carefully place the stone on top of the fabric to prevent damage to the geotextile.

When the geotextile is used between two layers of aggregate, there is a greater chance of stress and damage, so it is recommended to use a higher strength fabric.

***Maintenance***

Once the installation of the filter fabric system has been completed, it should require very little maintenance. It should, however, be inspected periodically to determine if high flows have caused scour beneath the fabric or dislodged any of the stone. If repairs are needed, they should be completed immediately.

***References***

City of Seattle

L. David Suits and Gregory N. Richardson on [www.geosynthetics.com](http://www.geosynthetics.com), FNW Geosynthetics Division

“Basic Geosynthetics: A Guide to Best Practices” Jonathan Fannin Ph.D., P. Eng., Forest Resources Management and Civil Engineering, University of British Columbia, Canada.

## 3.25 - VEGETATIVE BUFFER STRIP

---

### ***Introduction***

A vegetative buffer strip is the maintenance of existing or planted vegetation adjacent to streams, wetlands, or other areas of significant natural resource value for the purpose of stormwater pollutant removal. The term vegetative buffer is typically used to describe the preservation of existing vegetation without specific regard to pollutant removal efficiency, whereas the term filter strip is generally used when vegetation (usually grass) is specifically designed to achieve pollutant removal goals.

However, since the terms are often used interchangeably and provide essentially the same sediment removal function, both will be considered as one practice. However, developers should not destroy native vegetation to plant a grass strip for this practice. The protection of vegetation along streams also stabilizes stream banks, moderates water temperatures, and provides food sources and habitat for fish and wildlife.

### ***Conditions Where Practice Applies***

This practice may be utilized on construction sites with good existing vegetative cover or where good vegetative cover can be established prior to site disturbance. Vegetative buffers are most useful adjacent to streams, wetlands or other water bodies, although they may also be used as a non-structural practice on upland sites. To function effectively, runoff to and flow across the buffer area must not be concentrated or channelized. The use of level spreaders or other energy-dissipating devices may be utilized in some circumstances to promote overland (sheet) flow across the buffer. Buffers are probably more effective as filters during the growing season, when the density of vegetation is generally higher.

### ***Approved Practices***

1. Retaining existing native vegetation adjacent to the area to be protected. The width needed is dependent on site conditions (see design criteria).
2. Establishing vegetation by planting or natural regeneration adjacent to the area to be protected. The width and vegetation type is dependent on site conditions (see design criteria). Planting and/or natural regeneration can be used in conjunction with preserving existing vegetation if needed to achieve desired buffer width. All vegetation must be established prior to site disturbance.
3. Stormwater runoff to the buffer area must be in the form of overland (sheet) flow. If treatment occurs outside of the buffer, stabilized outlets may be located within the buffer area. The use of energy-dissipating devices may be used in some circumstances to promote overland flow within the buffer.
4. No disturbance is permitted within a vegetative buffer, except for necessary infrastructure improvements (utility lines, road crossings, etc.), or unless planting is required.

### ***Design Criteria***

It is recommended that designers use site-specific criteria to determine the

appropriate buffer width, if possible. Factors to consider include soil type, slope, size distribution of the sediment, contributing drainage area, vegetation present and other natural resource considerations, such as fish and wildlife habitat value. Because vegetative buffers along streams provide many environmental benefits, designers are encouraged to provide as large a buffer area as practicable for the project. If there is insufficient buffer width, the buffer available may be used in conjunction with other BMPs such as silt fence or super silt fence.

1. The minimum vegetative buffer width shall be 100 feet, unless specific design information can be provided to justify a smaller buffer width. For slopes greater than 10 percent, the minimum distance is 250 feet. Smaller buffers may be used in conjunction with other BMPs.
2. The width of the contributing area to the vegetative buffer should not exceed 300 feet, unless energy-dissipating devices are provided. Buffers may be used as a supplement to other BMPs for larger drainage areas.
3. Good (minimum of 80 percent) vegetative cover must be present in the proposed buffer area.

***Construction Specifications***

1. The buffer boundary shall be clearly marked onsite prior to site clearing or grading.
2. No soil disturbances, equipment storage or construction traffic shall occur within the buffer area.

***Maintenance***

Inspect at a minimum once every seven calendar days and within 24 hours after any storm event greater than 0.5 inches per 24 hour period. Heavy deposits of sediment should be removed (with minimal disturbance to the buffer vegetation). If erosion gullies form, the use of an energy- dissipating device or an alternative BMP is needed.

## 3.27 - SILT FENCE

---

### ***Introduction***

A temporary sediment barrier consisting of a synthetic filter fabric stretched across and attached to supporting posts and entrenched. Used to intercept and detain small amounts of sediment from disturbed areas during construction operations in order to prevent sediment from leaving the site.

No sediment control device is misused more than silt fence (with the possible exception of hay bales). Much of the silt fence used in West Virginia is not installed properly. The device does not work if:

1. not entrenched a minimum of 4 inches.
2. not placed on the contour-perpendicular to the flow of the water.
3. installed in areas of concentrated flows.
4. installed to contain sediment from too large of an area.
5. little or no maintenance is performed on it.

Silt fence does not actually filter sediment from muddy water. In field conditions silt fence acts as a barrier to the flow of water, like a dam, reducing the energy of the water, which causes the suspended material to settle out. It is because of the low permeability of the fabric that silt fence is limited to small drainage areas

Installing silt fence is very labor intensive. It is usually installed by hand and accumulated sediment must be removed and disposed of by hand. In many scenarios, installing a diversion and sediment trap would be more effective and less expensive than using silt fence. In addition, the NPDES permit requires that a sediment trap or basin be installed whenever possible.

### ***Conditions Where Practice Applies***

1. Below disturbed areas where erosion would occur in the form of sheet and small rill erosion.
2. Where the size of the drainage area is no more than one-quarter acre per 100 feet of silt fence length; the maximum gradient above the barrier should be less than 2:1.
3. Silt fence will not be used in areas where rock or some other hard surface prevents the full and uniform anchoring of the barrier.
4. Silt fence should NEVER be installed in streams or swales or in any area where there is a reasonable chance of concentrated flow. In areas where concentrated flows can be expected, use diversions and sediment traps and /or sediment basins. In ditches or swales rock check dams should be used in place of silt fence.

### ***Design Criteria***

1. No formal design is required. An effort should be made to locate silt fence at least 5 feet to 10 feet beyond the toe of slope.

2. Silt fence should be limited to situations in which only sheet is expected.
3. Silt fence should be installed prior to major soil disturbance.
4. Silt fence should be placed across the bottom of a slope along a line of uniform elevation (ALWAYS perpendicular to the direction of flow).
5. Any time a section of silt fence is knocked down by concentrated flows the silt fence will be replaced with a diversion and sediment trap or super silt fence.

***Construction Specifications***

***Materials***

1. Synthetic filter fabric shall be a pervious sheet of propylene, nylon, polyester or ethylene yarn and shall be certified by the manufacturer or supplier as conforming to the requirements noted in WV DOT DOH Specifications or the GEOTEXTILE section.
2. Synthetic filter fabric shall contain ultraviolet ray inhibitors and stabilizers to provide a minimum of 6 months expected usable construction life at a temperature range of 0 to 120 degrees Fahrenheit.
3. If wooden stakes are utilized for silt fence construction, they must be a minimum of 2" x 2" when oak is used and 2" x 4" when pine is used. Wooden stakes should have a minimum length of 5 feet.
4. If steel posts (standard "U" or "T" section) are utilized for silt fence construction, they must have a minimum weight of 1.33 pounds per linear foot and should have a minimum length of 5 feet.

***Installation***

1. The height of a silt fence shall be a minimum of 16 inches above the original ground surface and shall not exceed 34 inches above ground elevation.
2. The filter fabric shall be purchased in a continuous roll cut to the length of the barrier to avoid the use of joints. When joints are unavoidable, the silt fence shall be spliced together only at a support post, by twisting the last post of each run around the other, and securely sealed. (see drawing)
3. A trench shall be excavated approximately 4 inches wide and 4 inches deep on the upslope side of the proposed location of the measure.
4. The filter fabric shall be fastened securely to the upslope side of the posts using one inch long (minimum) heavy-duty wire staples or tie wires and eight inches of the fabric shall be extended into the trench. The fabric shall not be stapled to existing trees. The most common type of silt fence has the stakes attached to the fabric at the factory.
5. The 4-inch by 4-inch trench shall be backfilled and the soil compacted over the filter fabric.

6. Silt fence shall be removed when it has served its useful purpose, but not before the upslope area has been permanently stabilized.
7. Turn the end of a run of Silt Fence slightly uphill to prevent runoff from going around the end.

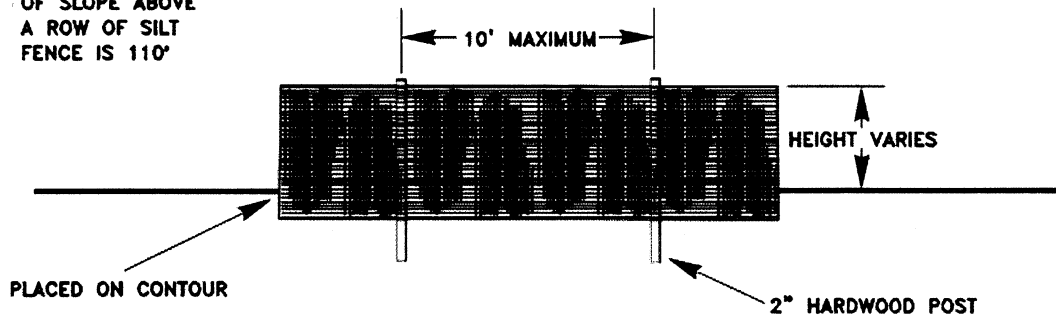
***Maintenance***

1. Silt fences shall be inspected immediately after each rainfall of 0.5 inch or greater and at least daily during prolonged rainfall or once a week. Any required repairs or maintenance shall be made immediately.
2. Close attention shall be paid to the repair of damaged silt fence resulting from end runs and undercutting. If the fence is not installed on the contour (perpendicular to the flow of the water) both of these conditions can occur.
3. Should the fabric on a silt fence decompose or become ineffective prior to the end of the expected usable life and the barrier still is necessary, the fabric shall be replaced promptly.
4. Sediment deposits should be removed after each storm event. They must be removed when deposits reach approximately one-half the height of the barrier.
5. If any section of silt fence is knocked down during a rain event (because it was installed in an area of concentrated flow) then other measures such as a sediment trap and diversion or super silt fence must be installed.

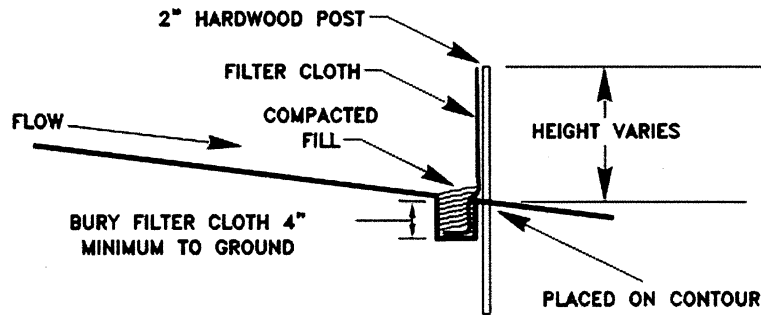
FIGURE 3.27.2

# SILT FENCE

NOTE:  
THE MAXIMUM LENGTH  
OF SLOPE ABOVE  
A ROW OF SILT  
FENCE IS 110'



## FRONT ELEVATION



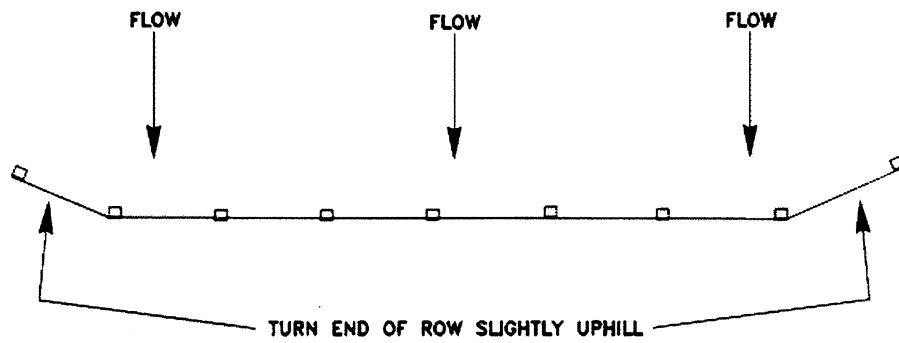
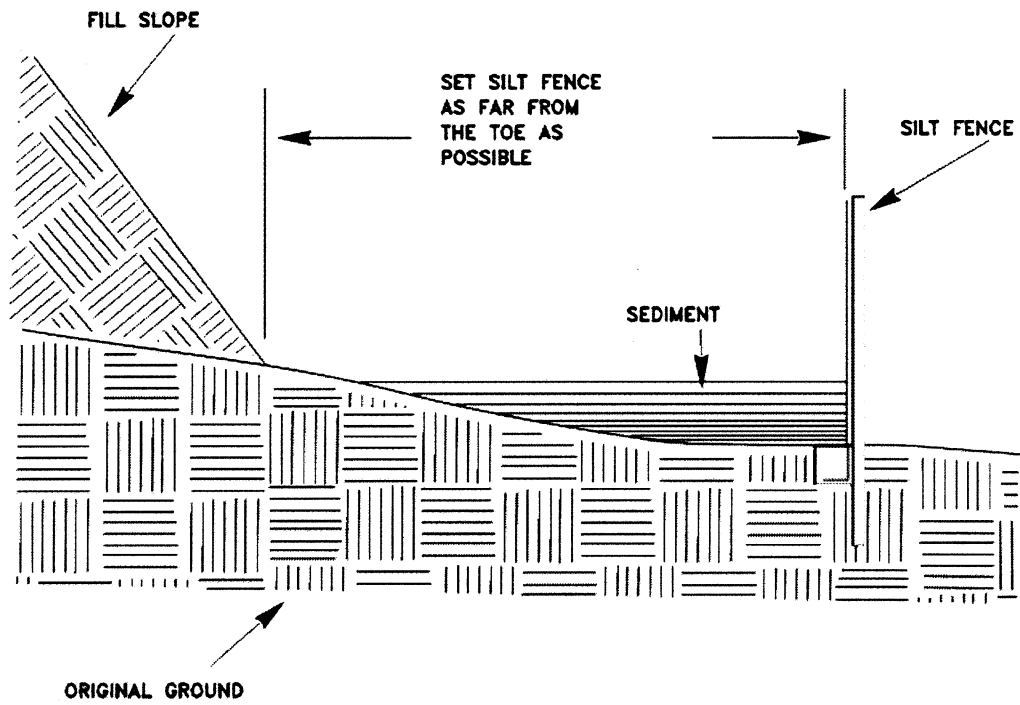
## SIDE ELEVATION



## TOP VIEW

FIGURE 3.27.1

# PLACEMENT OF SILT FENCE





## 3.28 - SUPER SILT FENCE

---

### ***Definition***

A super silt fence is a temporary barrier of geotextile fabric over chain link fence. It is used to intercept sediment-laden runoff from areas that are too large for regular silt fence. Super silt fence can be a replacement for sediment traps in certain instances.

### ***Conditions Where Practice Applies***

To reduce runoff velocity and allow sediment to become trapped behind or up slope of the super silt fence. Limits imposed by ultraviolet light stability of the fabric will dictate the maximum period that the silt fence may be used.

Super silt fence provides a barrier that can collect and hold debris and soil, preventing the material from entering critical areas, streams, streets, etc.

Super silt fence can be used where the installation of a DIVERSION and/or SEDIMENT TRAP would destroy sensitive areas, woods, wetlands, riparian zones, etc. This practice is very useful below bridge piers and abutments along streams and rivers.

### ***Design Criteria***

Design computations are not needed.

- Slope length above the fence should not exceed 400 ft in steep terrain. In flatter terrain the slope length can be extended with consultation with DWWM.
- Where ends of the geotextile fabric come together, the ends shall be overlapped, folded, and stapled to prevent sediment bypass.
- The backfilled trench shall be compacted.
- Only woven geotextile fabric will be used.
- Super silt fence should be placed as close to the contour as possible. No section of silt fence should exceed a grade of 5% for more than a distance of 20 feet.

### ***Construction Specifications***

Fencing shall be 48 inches in height and constructed in accordance with the WV DOT, Division of Highways specification for Chain Link Fencing. The DOT specification for a 6-foot fence shall be used, substituting 48-inch fabric and 6 foot length posts. The filter fabric shall meet the requirements of 715.11.5/AASHTO M 288, Section 7, Class 1.

1. The poles do not need to set in concrete.
2. Chain link fence shall be fastened securely to the fence posts with wire ties or staples.
3. Geotextile fabric shall be fastened securely to the chain link fence with ties spaced every 24" at the top and mid section.

4. Geotextile fabric shall be embedded a minimum of 12” into the ground.
5. When two sections of geotextile fabric adjoin each other, they shall be overlapped by 6” and folded.
6. Metal posts as specified by DOH can be replaced by pressure-treated 4” x 4” posts.

***Maintenance***

Silt fences shall be inspected immediately after each rainfall, daily during prolonged rainfall and once a week during dry periods. Any required repairs shall be made immediately.

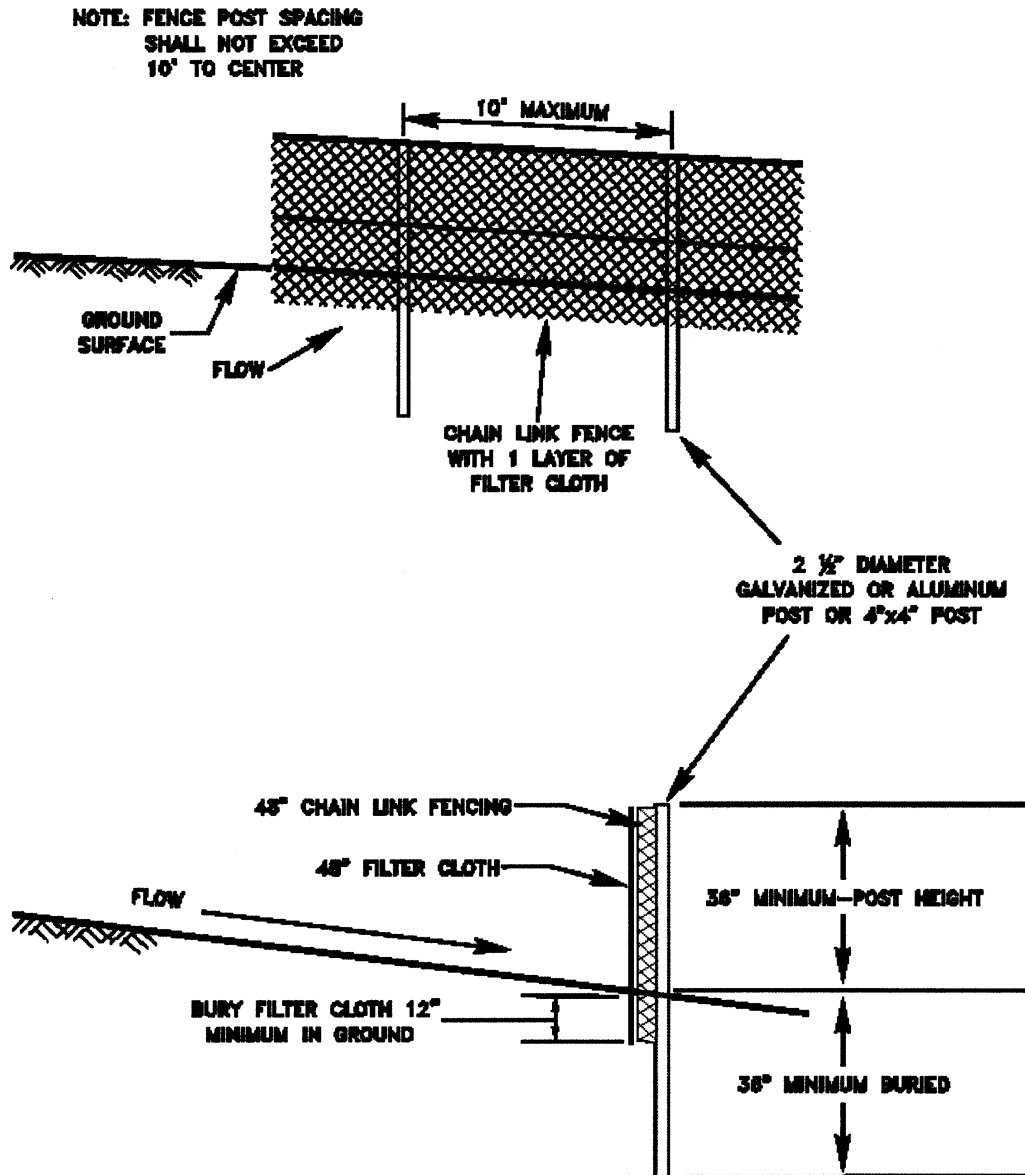
Close attention shall be paid to the repair of damaged silt fence resulting from end runs and undercutting. If the fence is not installed perpendicular to the flow of the water, these conditions will occur.

Should the fabric on a silt fence decompose or become ineffective, the fabric shall be promptly replaced.

Sediment deposits shall be removed when deposits reach approximately one-half the height of the barrier.

FIGURE 3.28.1

# *SUPER SILT FENCE*



## 3.29 - SEDIMENT TRAP

---

### ***Introduction***

A temporary ponding area formed by constructing an embankment or excavation and embankment that will trap the flow of sediment-laden runoff. Sediment traps have a properly stabilized outlet/weir or riser and pipe to detain sediment-laden runoff from small disturbed areas of five acres or less. Outlets must be designed to extend the detention time and allow the majority of the sediment to settle out.

This practice is one of the most efficient and cost effective methods of sediment control. When possible, sediment traps should be constructed as a first step in any land-disturbing activity. As with any sediment control device the sediment trap should not be removed until the contributing drainage area is stabilized.

Sediment traps can be highly variable in design and configuration. Almost every site has someplace to install one or more sediment traps. However it may not be evident during the design stages exactly where a trap would fit best. Once clearing, grubbing and site excavation begins, logical locations usually appear. It may be necessary to state in the plan that a particular trap will be field located to fit the site conditions.

### ***Conditions Where Practice Applies***

1. Sediment traps are appropriate for drainage areas of 5 acre or less. For drainage areas greater than 5 acres use a Sediment Basin (See SEDIMENT BASIN)
2. At the outlet of ditches and other perimeter controls installed during the first stage of construction.
3. At the outlet of any structure which concentrates sediment-laden runoff i.e. at the discharge point of diversions, channels, slope drains, or other runoff conveyances.
4. At the inlet to culverts underneath roads
5. Above a storm water inlet that may receive sediment-laden runoff.

### ***Design Considerations***

The following items should be addressed where applicable when planning and designing a sediment trap.

1. The sediment trap should have a storage volume of 3600 cubic feet per acre of drainage area. Half of the volume must be in the form of a permanent pool or wet storage to provide a stable-settling medium. The remaining half must be in the form of a drawdown or dry storage, which provides extended settling time. The volume of the wet storage should be measured from the low point of the excavated area to the base of the outlet structure or the invert of the first perforation in the riser. The volume of the dry storage should be measured from the base of the outlet to the crest of the outlet (overflow mechanism) or from the lowest perforation in the riser to the top of riser.

2. The embankment should not exceed 5 feet in height. The recommended minimum width at the top of the embankment should be equal to the height of the embankment.
3. The recommended inside embankment should be a 2:1 slope or flatter. The recommended outside embankment should be a 3:1 slope or flatter.
4. The width of the outlet channel weir must not be less than 4 ft. wide or, 2 feet plus 2 feet for each acre of drainage i.e. 12 ft wide for 5 acres. The top of the outlet channel must be at least 1 ft. below the top of embankment to provide a minimum of 1 ft. of free board.
5. The trap should be accessible for ease of maintenance.
6. Sediment must be removed from the trap when the trap's wet storage volume is reduced by one-half. Designers should designate a clean-out elevation.
7. The trap should provide a storage area which is at least twice as long as it is wide; with the outlet position at the furthest possible point from the inlet (measured from point of maximum runoff introduction to the outlet). Baffling can be used if this 2 to 1 ratio cannot be met.
8. All earthen side slopes should be a minimum of 2:1.
9. Seed and mulch all disturbed areas associated with the installation of the sediment trap immediately.
10. The sediment trap must have a stabilized outlet, either a weir or pipe and riser. Outlet protection must be provided.
11. Fill material around the pipe spillway where it goes through the embankment shall be hand compacted in 4" to 6" layers. A minimum of 2' of hand compacted backfill should be placed over the barrel before construction traffic is allowed to cross.
12. The riser shall be anchored with either a concrete base or steel plate bases sufficient to prevent flotation. For concrete bases, the depth shall be 12" with the riser buried 9". A 1/4" minimum thickness steel plate shall be attached to the riser by a continuous weld around the bottom to form a watertight connection and then place 2" of stone, gravel or tamped earth on the plate.
13. Anti-seep collars are required. Install based on manufacturers' instructions.
14. It is recommended that a concentric trash rack and anti-vortex device be installed on all risers.
15. If a stone outlet is used for the sediment trap, it should consist of a stone section of the embankment located at the low point in the basin. The stone outlet should be a combination of coarse aggregate and rock riprap. The stone section of the embankment should be separated from the earthen embankment by a geotextile. Riprap should consist of well-graded stone 2 inches to 8 inches in diameter. Coarse aggregate is washed gravel 1/2 to 1 1/2 inches in diameter. The coarse aggregate is placed 1 ft thick on the upstream face of the stone outlet. The crest of the stone outlet must be at least 1.0 foot below the top of the embankment to ensure that the flow will travel over the stone and not the embankment. The outlet should be configured as noted in the drawing.
16. The outlet pipe and riser should be sized as noted in the table below. The riser pipe should be weighted to prevent flotation. An anti-seep collar is

recommended around the outlet pipe as well as a concentric trash rack and anti-vortex device.

17. If there is any chance that a failure of the structure could damage any downstream property, the designer should look into creating a spillway or combination of spillways commensurate with the level risk should the structure fail.
18. The inlet to the sediment trap should be excavated to provide for a gentle transition from the diversion ditch to the bottom of the trap to protect from head cutting and scour.
19. The maximum depth of excavation within the wet storage area should be 4 feet to facilitate clean-out and for site safety considerations

**Table 3.29.1 PIPE OUTLET DIAMETER SELECTION**

Maximum Drainage Area (Acres)	Minimum Size Outlet Diameter (inches)	Minimum Size Riser Diameter (inches)
1	12	15
2	15	18
3	18	21
4	21	24
5	21	27

**Volume calculation**

For an embankment sediment trap, the **wet storage volume** may be approximated as follows:

$$V_1 = 0.85 \times A_1 \times D_1$$

where,

$V_1$  = the wet storage volume in cubic feet

$A_1$  = the surface area of the flooded area at the base of the stone outlet, in square feet

$D_1$  = the maximum depth in feet, measured from the low point in the trap to the base of the stone outlet

The **dry storage volume** may be approximated as follows:

$$V_2 = \frac{A_1 \times D_2}{2} \times D_2$$

where,

$V_2$  = the dry storage area of the flooded area at the base of the stone outlet in square feet

$A_1$  = the surface area of the flooded area at the base of the stone outlet, in square feet

$A_2$  = the surface area of the flooded area at the crest of the stone outlet (overflow mechanism), in square feet

$D_2$  = the depth in feet, measured from the base of the stone outlet to the crest of the stone outlet

**Plan  
Preparation**

During the preparation of the sediment control plan for the Construction Storm Water General Permit prepare a table detailing the key design aspects of each sediment trap planned and designed.

**Table 3.29.2 SEDIMENT TRAP KEY DESIGN ASPECTS**

TRAP NUMBER	1	2	3	4	5	6
TYPE (stone weir/pipe)						
DRAINAGE AREA						
WET STORAGE REQ						
WET STORAGE PROV						
DRY STORAGE REQ						
DRY STORAGE PROV						
WEIR WIDTH						
PIPE DIAMETER						
WEIR/PIPE ELEVATIONS						
STORAGE DEPTH						
CLEANOUT ELE						
EMBANKMENT ELE						
TRAP BOTTOM ELE						

**Construction  
Specifications**

1. The area under the embankment should be cleared, grubbed, and stripped of any vegetation and root mat.
2. Fill material for the embankment should be free of roots or other woody vegetation, organic material, large stones, and other objectionable material. The embankment should be compacted in 6-inch layers by traversing with construction equipment.
3. The earthen embankment should be seeded and mulched to provide temporary or permanent vegetation immediately after installation.
4. Construction operations should be carried out in such a manner that erosion and water pollution are minimized.
5. Sediment Traps should not be removed until the contributing disturbed area has been stabilized.
6. Material removed from the excavated section of the sediment trap should be placed in an area and stored in a manner that will not create an erosion problem.

7. The outlet pipe and riser connections should be watertight.
8. Above the wet storage elevation, the riser should be perforated with 1-inch diameter holes spaced 8 inches vertically and 10 inches to 12 inches horizontally.

***Maintenance***

Sediment should be removed from the trap before the traps wet storage volume is reduced by one-half. Sediment removed from the trap should be stored or disposed in a manner in which will not create an erosion or sediment problem.

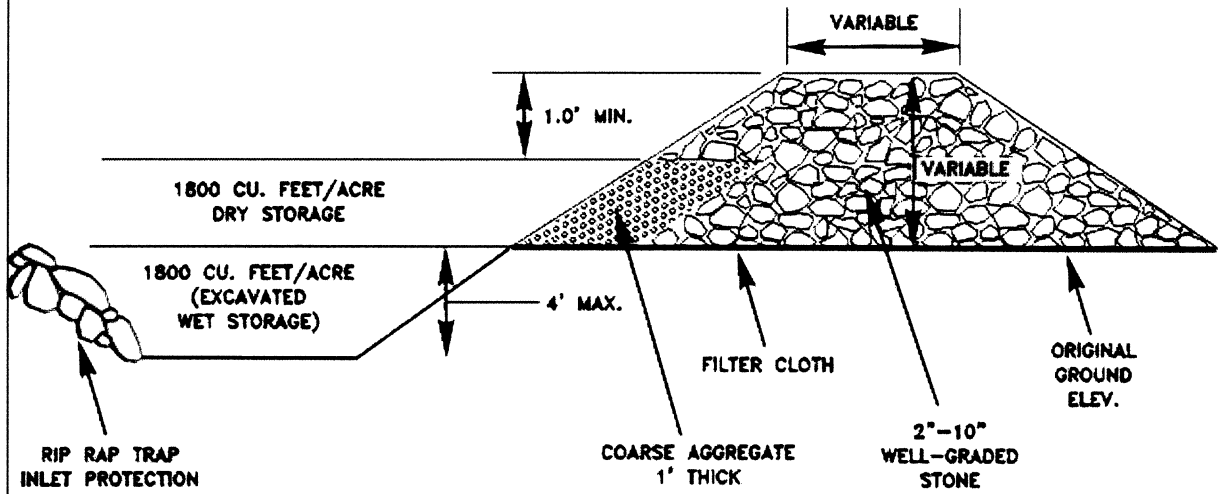
Filter stone should be regularly checked to ensure that filtration performance is maintained. Stone choked with sediment should be removed and cleaned or replaced

The structure shall be checked every 7 days and /or after 0.5 inch of rain to ensure that it is structurally sound and has not been damaged.

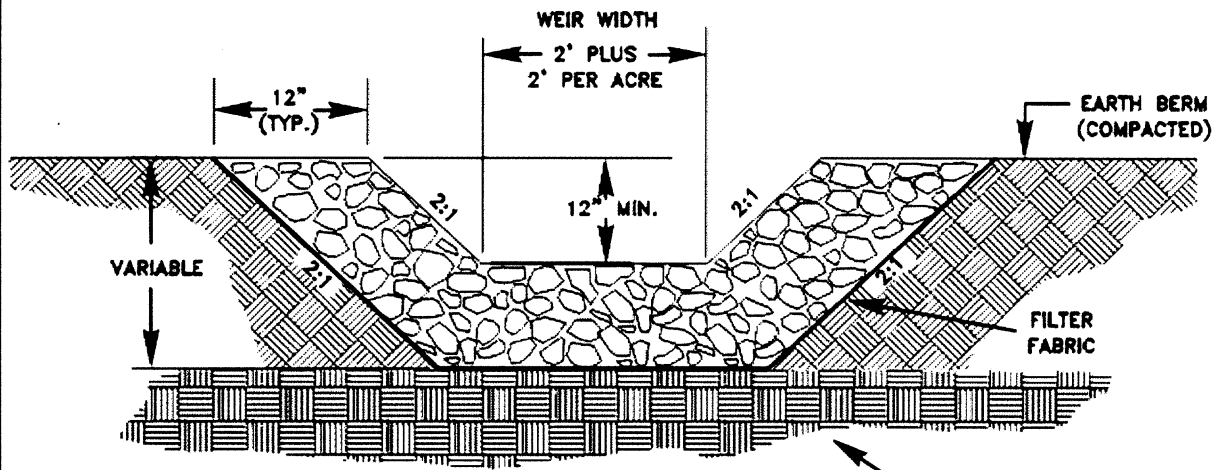


FIGURE 3.29.1

# ROCK OUTLET SEDIMENT TRAP



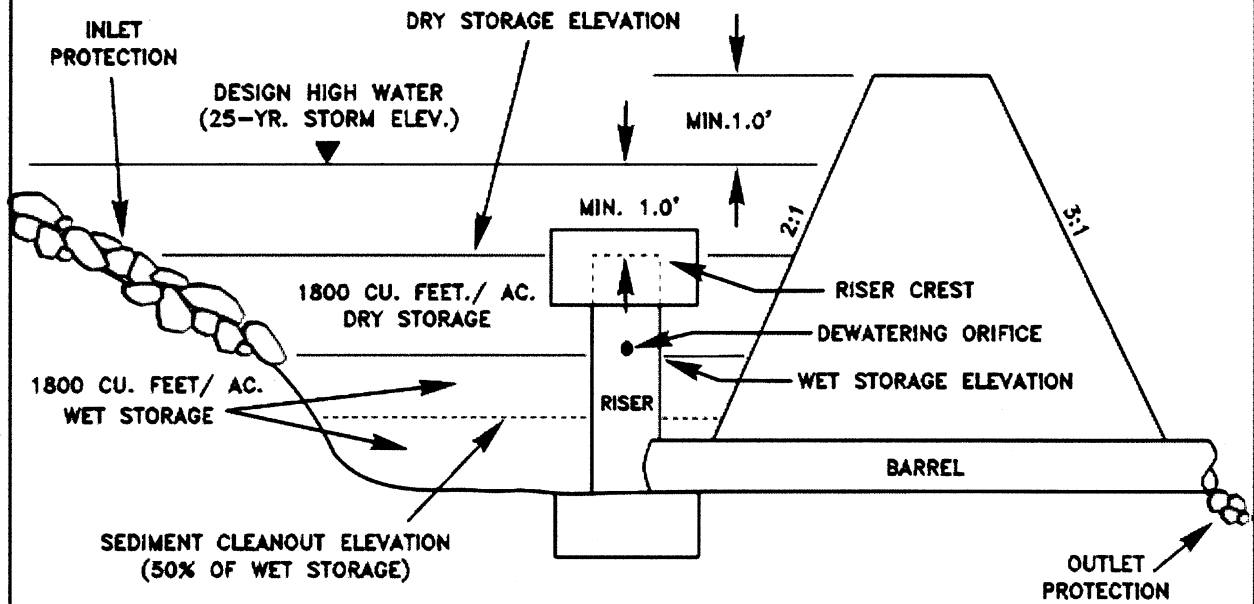
## CROSS SECTION



## ELEVATION

FIGURE 3.29.2

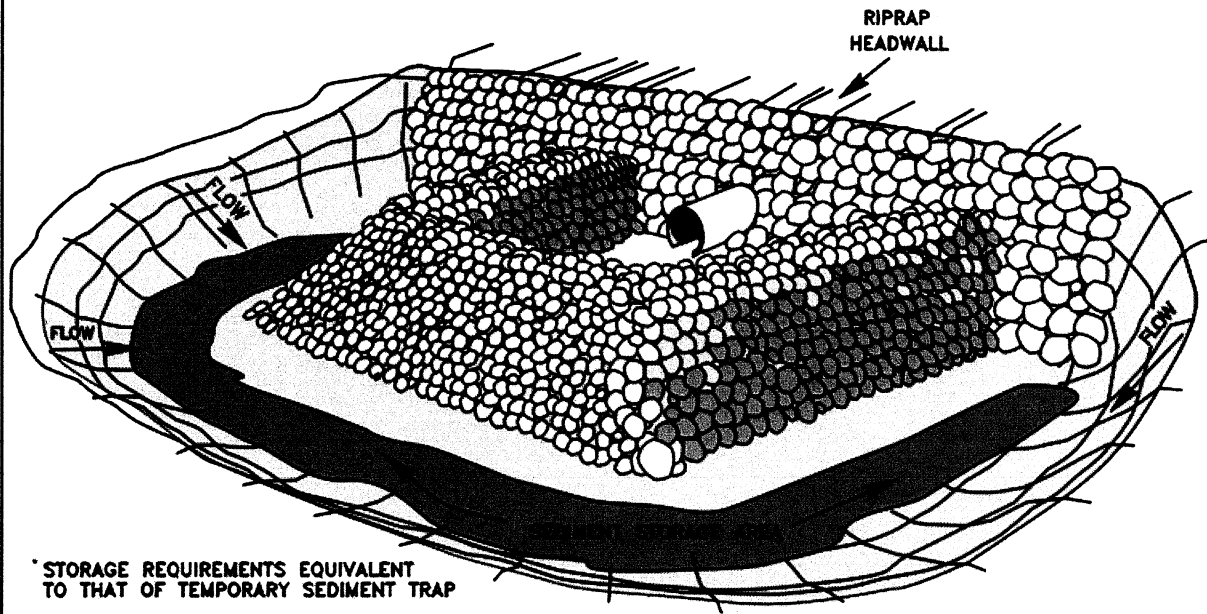
# PIPE RISER SEDIMENT TRAP



ADAPTED FROM: VA. DSWC

FIGURE 3.29.3

# CULVERT INLET SEDIMENT TRAP

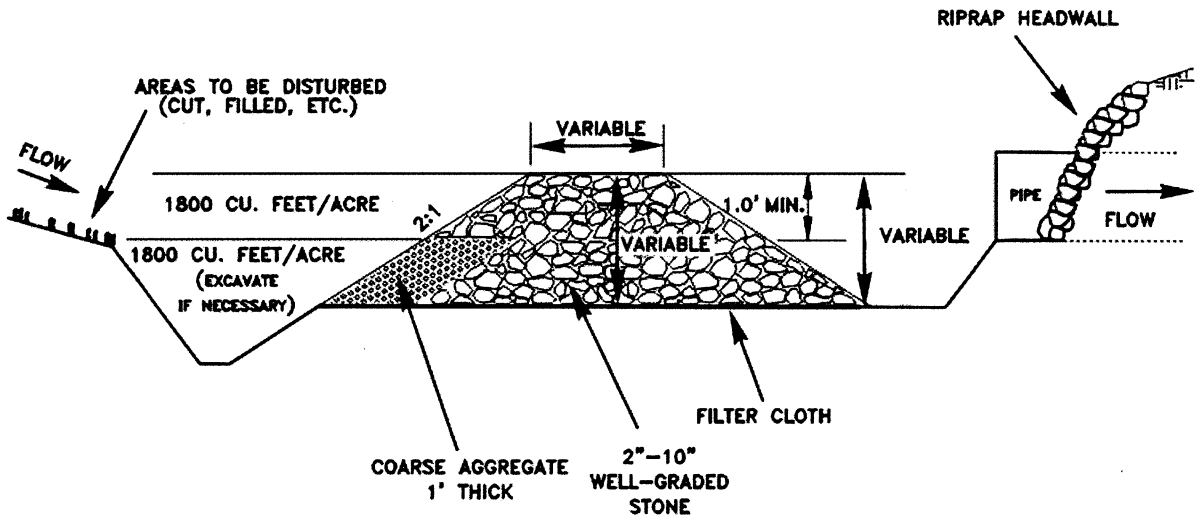


STORAGE REQUIREMENTS EQUIVALENT TO THAT OF TEMPORARY SEDIMENT TRAP

1800 CU FEET/ACRE WET STORAGE (BELOW INVERT OF PIPE)

1800 CU FEET/ACRE DRY STORAGE (INVERT OF PIPE TO TOP OF STONE BERM)

## PERSPECTIVE VIEW



## CROSS SECTION

From VA DSWC

## 3.30 - SEDIMENT BASIN

---

### ***Introduction***

A temporary structure consisting of an earthen embankment, or embankment and excavated area, located in a suitable area to capture sediment laden runoff from a construction site. A sediment basin reduces the energy of the water through extended detention (48 to 72 hours) to settle out the majority of the suspended solids and sediment and prevent sedimentation in waterways, culverts, streams and rivers. Sediment basins have both wet and dry storage space to enhance the trapping efficiency and are appropriate in drainage areas of 5 acres and greater. For drainage areas of less than 5 acres see the standard for SEDIMENT TRAP.

Basins are dewatered through a riser and drainage hole(s) or a skimmer system. Because sediment basins are located in larger drainage areas and the failure of a structure could cause significant damage or death they need to be designed to safely pass the peak discharge from a 25-year/24-hour storm with one foot of freeboard.

They are temporary structures but are often modified to function as a permanent structure after construction is completed.

Properly designed and maintained sediment basins can be very effective in preventing sedimentation of downstream areas. Coarse and medium size particles and associated pollutants will settle out in the basin. Suspended solids and attached nutrients may break down before proceeding downstream.

The effectiveness of sediment trapping structures is greatly improved by use of aggressive erosion control (especially in diversions leading to the basin) in the contributing drainage.

### ***Conditions Where Practice Applies***

Sediment basins are needed where drainage areas exceed the design criteria of other measures. Sediment traps are allowed in watersheds of 5 acres and less. General criteria for installation of a sediment basin are as follows:

1. Keep the drainage area less than 100 acres;
2. Ensure that basin location provides a convenient concentration point for sediment-laden flows from the area served;
3. Ensure that basin location allows access for sediment removal and proper disposal under all weather conditions;
4. Keep the basin life limited to 1 year, unless it is designed as a permanent structure;
5. Should not locate sediment basins in intermittent or perennial streams;
6. Sediment basins must dewater in 2 to 3 days;

7. Skimmers can be used to enhance trapping efficiency, however perforated risers are also acceptable;
8. Install basins where they will not interfere with construction activities.

***Planning  
Considerations***

Select key locations for sediment basins during initial site evaluation. Install basins before any site grading takes place within the drainage area. Select basin sites to capture sediment from all areas that are not treated adequately by other sediment trapping devices. Always consider access for cleanout and disposal of the trapped sediment. Locations where a pond can be formed by constructing a low dam across a natural swale are generally preferred to sites that require excavation. If practical, divert sediment-free runoff away from the basin. This will help reduce the size of the structure and decrease the amount of erosion on the construction site.

Sediment trapping efficiency is primarily a function of sediment particle size, the ratio of basin surface area to inflow rate and the ability of the basin to reduce the energy of the water. Therefore, design the basin to have a large surface area for its volume and the maximum amount of detention time.

The performance of sediment trapping structure depends on several factors:

1. The size and shape of the basin
2. The soil properties
3. Runoff volume and flow rates
4. Water chemistry
5. Outlet type
6. Temperature

Structures larger than 25 feet in height from the downstream toe to highest point along the crest of the dam and have a maximum storage capacity of 15 acre-feet of water or more are subject to the West Virginia Dam Safety Act.

By virtue of their potential to impound and release large volumes of water, the design of sediment basins is required to be completed by professionals trained in the design of impounding structures, and in accordance with good engineering practices. Sediment basins with an expected life greater than 1 year should be designed as permanent structures. Permanent ponds must be designed and certified by a Professional Engineer. Permanent pond design is beyond the scope of this manual. For further information the USDA Soil Conservation Service Practice Standard Ponds Code No. 378 is an excellent source of information and provides criteria for design of permanent ponds.

In larger drainages or when the discharge is to a Tier 2.5 or 3 Stream, an alternative design procedure that more accurately defines the specific

hydrology, sediment loading, hydraulics of the site, and the control measures in use be utilized to perform design calculations. The design criterion in this manual does not generate hydrographs, estimate erosion and delivery rates, provide hydraulic routing or predict sediment capture efficiency. More rigorous and accurate design considerations that are more site specific than those in this manual, are acceptable and encouraged with any size basin.

The design and construction of sediment basins shall comply with all state and local laws, ordinances, permit requirements, rules and regulations. Basins shall be constructed according to the approved Storm Water Pollution Prevention Plan (SWPPP) unless modified a engineering design professional.

Sediment basins must dewater in 2 to 3 days. Skimmers are the preferred dewatering device, however perforated risers are also acceptable.

Sediment basins should be provided with an emergency spillway constructed in original ground with a minimum bottom width of 8'. Energy dissipaters must be included at all inlet and outfalls to prevent scouring.

Sediment basins are attractive to children and can be very dangerous. Local ordinances regarding health and safety must be adhered to. If fencing of the basin is required, the type of fence and its location should be shown in the SWPPP and in the construction specifications.

Limit the contributing area to the sediment basin to only the runoff from the disturbed soil areas. Use temporary water controls to divert runoff from undisturbed areas away from the sediment basin.

The basin should be located: (1) by excavating a suitable area or where a low embankment can be constructed across a swale, (2) where post-construction (permanent) detention basins will be constructed, and (3) where the basins can be maintained during construction to provide access for maintenance, including sediment removal and sediment stockpiling in a protected area, and to maintain the basin to provide the required capacity.

As with all sediment control device it must be maintained until the drainage area is permanently stabilized.

Provide construction details for each proposed sediment basin on the erosion and sediment control plans. Show all significant features and elevations on those plans.

### ***Design Criteria***

**Drainage areas**—Limit drainage areas to 100 acres.

**Design basin life**—Ensure a design life of 1 year or more.

**Dam height**—Limit dam height to 15 feet if possible. Height of a dam is measured from the highest point of the dam to the lowest point at the downstream toe. According to the Dam Control Act the volume is measured to the highest point on the top of the dam.

**Basin locations**—Select areas that:

Provide capacity for storage from as much of the planned disturbed area as practical;

Exclude runoff from undisturbed areas, where practical;

Provide access for sediment removal throughout the life of the project and;

Interfere minimally with construction activities.

**Basin shape**—It is important that the designer of the sediment basin incorporate features to maximize detention time and reduce the energy of the inflow before water is discharged. Some of the methods to improve basin geometry:

1. Length to width ratio of at least 2:1, with 4:1 optimal. Try not to exceed 6:1 as basin velocities can increase and the basin starts to behave as a channel. Length is measured at the elevation of the principal spillway.
2. Wedge shape with the inlet at the narrow end. Line up the inlet, riser and center of the dam.
3. Installation of baffles
4. Maximize surface area to provide efficient settling.

**Storage volume**—Ensure that the sediment storage volume of the basin, measured at the elevation of the crest of the principal spillway, is at least 3,600 cubic feet per acre of the total area draining into the basin.

Unless using a skimming device, half of the volume shall be in wet storage and half of the storage shall be in dry storage. Use the maximum drainage area found at any point during construction. Since watersheds often change during grading operations, the largest drainage area is not necessarily the pre- or post-construction drainage area. The maximum watershed area used to size the basin should be delineated on the drawings.

Remove sediment from the basin when approximately one-half of the wet storage volume has been filled. Show this elevation in the plans and provide a method of determining it in the field.

When the construction of a single basin with storage volume of 3600 cubic feet per acre is not feasible due to site constraints it can be advantageous to install several smaller structures in series with a

combined storage volume of 3600 cubic feet. Creating a fore bay can also improve the trapping efficiency.

The volume requirements of the General Permit and this standard should be regarded as the minimum necessary to protect water quality. The design professional is encouraged to increase these storage requirements to protect a critical aquatic resource such as Tier 2.5 or 3 streams or the safety/health of the public. The following conditions could require additional storage or increased spillways capacity:

1. Highly erodible soils
2. Steep upslope topography
3. Space limiting basin geometry (depth or shape)
4. Degree to which off-and/or on-site runoff is diverted from the contributing undisturbed areas
5. Sediment cleanout schedule
6. Ease of access to clean out basin
7. Flocculant use
8. Extent of upslope erosion and sediment control
9. Critical downstream conditions

**Minimum depth** The sediment basin should be at least two feet deep.

**Spillway capacity**—The combined spillway system must carry the peak runoff from the 25-year/24 hour storm with a minimum 1-foot of freeboard.

Base peak flow runoff computations on the largest disturbed area expected and the worst soil cover conditions during the effective life of the structure.

Sediment basin spillways must be able to discharge 2 cfs/acre from the entire contributing watershed. However, if this rule of thumb is used, a minimum of 24 inches of freeboard will be required above the elevation of the 2 cfs/acre. If the emergency spillway is being used to provide part of the 2 cfs/acre discharge, the freeboard must be provided above the design flow elevation in the emergency spillway.

**Principal spillway**—Construct the principal spillway with a vertical riser connected to a horizontal barrel that extends through the embankment and outlets beyond the downstream toe of the dam, or an equivalent design.

• **Capacity**—The primary spillway system should carry the peak runoff from the 2-year storm, with the water surface at the emergency spillway crest elevation.

**Basin dewatering** A sediment basin must be able to dewater the dry storage volume in 48 to 72 hours. There are two traditional ways to accomplish this



The basin should be provided either with a perforated riser with a hole or series of holes at the wet storage elevation or to enhance the trapping efficiency a surface skimmer.

**Dewatering orifice**---In order to dewater the sediment basin in 48 to 72 a hole or several holes that add up to  $A_o$  should be cut into the riser.

$$A_o = A_s \times (2h)^{0.5} / (T \times C_d \times 20,428)$$

where

$A_o$  = total area of dewatering holes, ft<sup>2</sup>;

$A_s$  = surface area of the basin, ft<sup>2</sup>;

h = head of water above the hole, ft;

$C_d$  = coefficient of contraction for an orifice, approximately 0.6;

T = detention time or time needed to dewater the basin, hours

• **Skimmer**—A floating skimmer may be attached to the base of the riser. The orifice in the skimmer will control the rate of dewatering. The skimmer should be sized to dewater the basin in 48-72 hours.

Use the manufacturers Installation Manual to size the skimmer orifice. See SKIMMER BASIN for details on the installation of skimmers.

**Sediment cleanout elevation**—The clean out elevation is 50 percent of the wet storage elevation. Indicate on the drawings this elevation and mark in the field with a permanent stake.

**Crest elevation**—Keep the crest elevation of the riser a minimum of 1 foot below the crest elevation of the emergency spillway.

**Riser and Barrel**—Keep the minimum barrel size at 15 inches for corrugated metal pipe or 12 inches for smooth wall pipe to facilitate installation and reduce potential for failure from blockage. Ensure that the pipe is capable of withstanding the maximum external loading without yielding, buckling or cracking. To improve the efficiency of the principal spillway system, make the cross-sectional area of the riser at least 1.5 times that of the barrel. The riser should be sized to minimize the range of stages when orifice flow will occur.

**Pipe Connections**—Ensure that all conduit connections are watertight.

Rod and lug type connector bands with gaskets are preferred for corrugated metal pipe to assure water tightness under maximum loading and internal pressure. Do not use dimple (universal) connectors under any circumstances.

It is important that a suitable trash guard be installed to prevent the dewatering holes from becoming clogged.

**Trash rack**—Install a trash rack on the top of the riser to prevent trash and other debris from clogging the conduit. A combination anti-vortex device and trash rack improves the efficiency of the principal spillway and protects against trash intake.

**Protection against piping**—Install at least one watertight anti-seep collar with a minimum projection of 1.5 feet around the barrel of principal spillway conduits, 8 inches or larger in diameter. Locate the anti-seep collar slightly downstream from the dam centerline. A properly designed drainage diaphragm installed around the barrel may be used instead of an anti-seep collar when it is appropriate.

**Protection against flotation**—Secure the riser by an anchor with buoyant weight at least 1.25 times greater than the water displaced by the riser.

**Outlet**—Protect the outlet for the barrel against erosion. Discharge velocities must be within allowable limits for the receiving stream. (See OUTLET PROTECTION)

**Emergency spillway**—Construct the entire flow area of the emergency spillway in undisturbed soil (not fill). Make the cross section trapezoidal at least 8 feet wide and with side slopes of 3:1 or flatter. Make the control section of the spillway straight and at least 20 feet long. The inlet portion of the spillway may be curved to improve alignment, but ensure that the outlet section is straight due to supercritical flow in this portion. The channel should be located so as to avoid sharp bends. The outlet of the spillway channel should be to a defined natural channel downstream of the toe of the embankment.

**Capacity**—The minimum design capacity of the emergency spillway must be the peak rate of runoff from the 25-year/24 hour storm, less any reduction due to flow in the principal spillway. In no case should freeboard of the emergency spillway be less than 1 foot above the design depth of flow.

**Outlet Velocity**—Ensure that the velocity of flow discharged from the basin is non-erosive for the existing conditions. When velocities exceed that allowable for the receiving areas, provide outlet protection (See OUTLET PROTECTION).

### **Embankment Design Standards**

**Cut-off trench** Excavate a minimum of 2 feet wide trench with 1:1 side slopes at the centerline of the embankment. Ensure that the trench is in undisturbed soil and extends through the length of the embankment to the elevation of the riser crest at each end. A minimum of 2 feet depth is recommended.

**Top width** The minimum top width of the dam is as follows.

## Acceptable Dimensions for Basin Embankment

<u>Fill Height</u>	<u>minimum top Width</u>
less than 10 ft	8.0 ft
10 ft to 15 ft	10.0 ft
16 ft to 25 ft	15.0 ft

**Freeboard** Ensure that the minimum difference between the design water elevation in the emergency spillway and the top of the settled embankment is 1 foot.

**Side slopes** Make the side slopes of the impoundment structure so that the total slope of both sides equals 5:1 or flatter. IE. If the upstream slope is 2:1 the downstream must be 3:1 but at no time shall an embankment slope exceed 2:1.

**Allowance for settlement** Increase the constructed height of the fill at least 10 percent above the design height to allow for settlement.

**Erosion protection** Stabilize all areas disturbed by construction (except the lower 1/2 of the wet storage pool) by suitable means immediately after completing the basin.

**Trap efficiency** Sediment basin trapping efficiency can be improved by using the following considerations in the basin design:

**Surface area** In the design of the settling pond, allow the largest surface area possible. Studies indicate that surface area (in acres) should be larger than 0.01 times the peak inflow rate in cfs.

$$A = 0.01q$$

where A is the basin surface area in acres and q is the peak inflow rate in cubic feet per second

**Length** The length to width ratio should be between 2:1 to 6:1.

**Baffles** Provides a minimum of two baffles to evenly distribute flow across the basin and reduces turbulence. See specification on BAFFLES.

**Inlets** Locate the sediment inlets to the basin the greatest distance from the principal spillway. Protect the inlet from scour and erosion with appropriate riprap protection. If there is room, provide a forebay to help slow the speed of the water down.

**Inflow rate** Reduce the inflow velocity and divert all sediment-free runoff away from the basin's watershed.

A summary table showing all critical dimensions and elevations for each basin should be prepared for the construction drawings and the NPDES application.

## **Construction Specifications**

**Site preparation**—Install appropriate sediment and provide erosion controls as required. Clear, grub, and strip topsoil from areas under the embankment to remove trees, vegetation, roots, and other objectionable material. Delay clearing the pool area until the dam is complete and then remove brush, trees, and other objectionable materials to facilitate sediment cleanout and prevent floatables that can clog the outlets. Stockpile all topsoil or soil containing organic matter for use on the outer shell of the embankment to facilitate vegetative establishment.

**Cut-off trench**—Excavate a cut-off trench along the centerline of the earth fill embankment. Cut the trench to stable soil material, but in no case make it less than 2 feet deep. The cut-off trench must extend into both abutments to at least the elevation of the riser crest. Make the minimum bottom width wide enough to permit operation of excavation and compaction equipment, but in no case less than 2 feet. Make side slopes of the trench no steeper than 1:1. Compaction requirements are the same as those for the embankment. Keep the trench dry during backfilling and compaction operations.

**Embankment Core** - The core shall be parallel to the centerline of the embankment as shown on the plans. The top width of the core shall be a minimum of four feet. The height shall extend up to at least to the top of the riser or as shown on the plans. The side slopes shall be 1 to 1 or flatter. The core shall be compacted with construction equipment, rollers, or hand tampers to assure maximum density and minimum permeability. In addition, the core shall be placed concurrently with the outer shell of the embankment.

**Embankment**—Take fill material from the approved areas shown on the plans. It should be clean mineral soil, free of roots, woody vegetation, rocks, organic topsoil and other objectionable material. Scarify areas on which fill is to be placed before placing fill. Fill material for the center of the embankment, and cut off trench shall conform to Unified Soil Classification GC, SC, CH, or CL and must have at least 30% passing the #200 sieve. The fill material must contain sufficient moisture so it can be formed by hand into a ball without crumbling. If water can be squeezed out of the ball, it is too wet for proper compaction.

Place fill material in 8 inch continuous layers over the entire length of the fill area and compact it. Hand compact areas around the anti-seep collars. Compaction may be obtained by routing the construction hauling equipment over the fill so that the entire surface of each layer is traversed by at least one wheel or tread track of heavy equipment, or a compactor may be used. Construct the embankment to an elevation 10 percent higher than the design height to allow for settling.

As an alternate, the following can be used to specify embankment placement. The minimum required density shall not be less than 95% of

maximum dry density with a moisture content within 2% of the optimum. Each layer of fill shall be compacted as necessary to obtain that density, and is to be certified by the Engineer at the time of construction. All compaction is to be determined by AASHTO Method T-99 (Standard Proctor).

**Conduit spillways**—Securely attach the riser to the barrel or barrel stub to make a watertight structural connection. Secure all connections between barrel sections by approved watertight assemblies. The backfill adjacent to pipes or structures shall be of the type and quality conforming to that specified for the adjoining fill material. Place the barrel and riser on a firm, smooth foundation of impervious soil. Do not use pervious material such as sand, gravel, or crushed stone as backfill around the pipe or antiseep collars. Place the fill material around the pipe spillway in 4-inch layers, and compact by hand tampers or other manually directed compaction equipment under and around the pipe to at least the same density as the adjacent embankment. The material needs to fill completely all spaces under and adjacent to the pipe. The pipe shall be firmly and uniformly bedded throughout its entire length. Where rock or soft, spongy or other unstable soil is encountered, all such material shall be removed and replaced with suitable earth compacted to provide adequate support. Care must be taken not to raise the pipe from firm contact with its foundation when compacting under the pipe haunches. At no time during the backfilling operation shall driven equipment be allowed to operate closer than four feet, measured horizontally, to any part of a structure. Place a minimum depth of 2 feet of compacted backfill over the pipe spillway before crossing it with construction equipment.

Anchor the riser in place by concrete or other satisfactory means to prevent flotation.

In no case should the pipe conduit be installed by cutting a trench through the dam after the embankment is complete.

**Emergency spillway**—Install the emergency spillway in undisturbed original ground. The achievement of planned elevations, grade, design width, and entrance and exit channel slopes are critical to the successful operation of the emergency spillway.

**Inlets**—Discharge water into the basin in a manner to prevent erosion. Use diversions with outlet protection to divert sediment-laden water to the upper end of the pool area to improve basin trap efficiency (See DIVERSIONS and OUTLET PROTECTION).

**Erosion control**— The installation of a sediment basin can in some instances be a significant construction project in its own right. The designer must create a comprehensive sediment control plan for each sediment basin installation.

Install appropriate sediment control prior to starting constructing. Minimize the disturbed area. Divert surface water away from bare areas and around the embankment footprint. Complete the embankment before the remaining construction site is cleared. Stabilize the emergency spillway embankment and all other disturbed areas above the wet storage elevation immediately after construction. Install Riprap channel protection in the emergency spillway if needed and at the outlet of the pipe.

**Care of Water during Construction** --All work on permanent structures shall be carried out in areas free from water. The contractor shall construct and maintain all temporary dikes, levees, cofferdams, drainage channels, and stream diversions necessary to protect the areas to be occupied by the permanent works. The contractor shall also furnish, install, operate, and maintain all necessary pumping and other equipment required for removal of water from various parts of the work and for maintaining the excavations, foundation, and other parts of the work free from water as required or directed by the engineer for constructing each part of the work.

After having served their purpose, all temporary protective works shall be removed or leveled and graded to the extent required to prevent obstruction in any degree whatsoever of the flow of water to the spillway or outlet works and so as not to interfere in any way with the operation or maintenance of the structure. Stream diversions shall be maintained until the full flow can be passed through the permanent works.

The removal of water from the required excavation and the foundation shall be accomplished in a manner and to the extent that will maintain stability of the excavated slopes and bottom required excavations and will allow satisfactory performance of all construction operations. During the placing and compacting of material in required excavations, the water level at the locations being refilled shall be maintained below the bottom of the excavation at such locations which may require draining the water sumps from which the water shall be pumped.

**Baffles** Install baffles as specified in Baffles section.

**Safety**—Sediment basins may attract children and can be dangerous. Avoid steep side slopes, and fence and mark basins with warning signs if trespassing is likely. Follow all state and local requirements.

***Sediment Basin  
Removal  
and Cleanup***

**Final cleanup and disposition** : The designer shall prepare a Sediment Control Plan for the removal of all sediment-trapping structures. Include in the Plan the method for dewatering the wet storage and removal of the trapped sediments.

Once the site is stabilized and the basin is no longer needed the structure shall be removed and the original contours reestablished. Sediment shall be removed so it cannot reenter a waterway.

Dewatering must not cause water quality violations. See the Basin or Sediment Trap Sediment Storage Dewatering Facility drawing for approved procedures to dewater a basin or trap.

All disturbed areas will be seeded and mulched immediately according to the specifications in this manual.

***Maintenance***

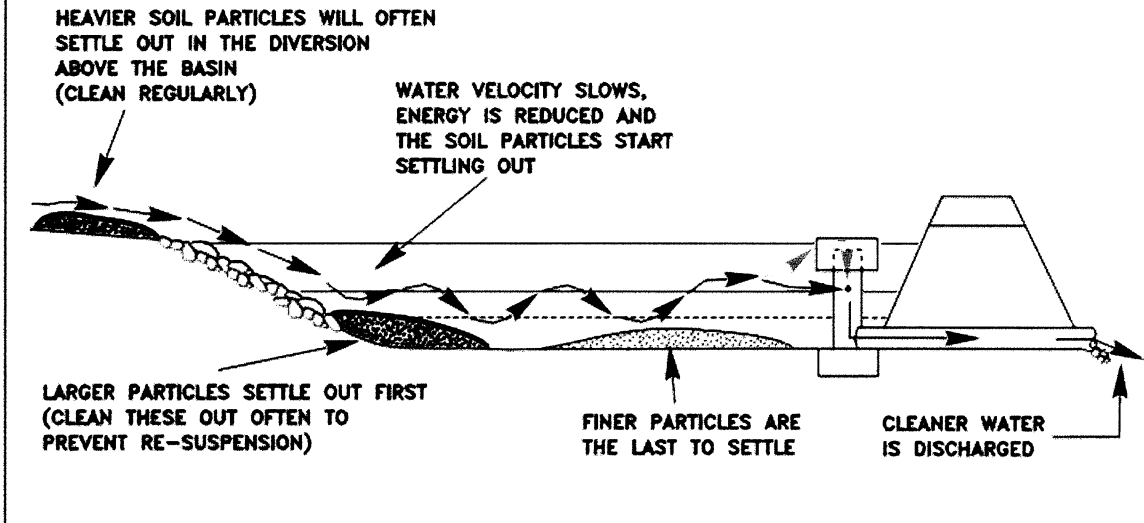
Inspect temporary sediment basins weekly and after each rainfall event 0.5 inch or greater and repair immediately.

Provide access for sediment removal and other required maintenance activities. Remove sediment and restore the basin to its original dimensions when it accumulates to one-half the wet storage depth. Place removed sediment where there is no possibility of its reentry into a waterway.

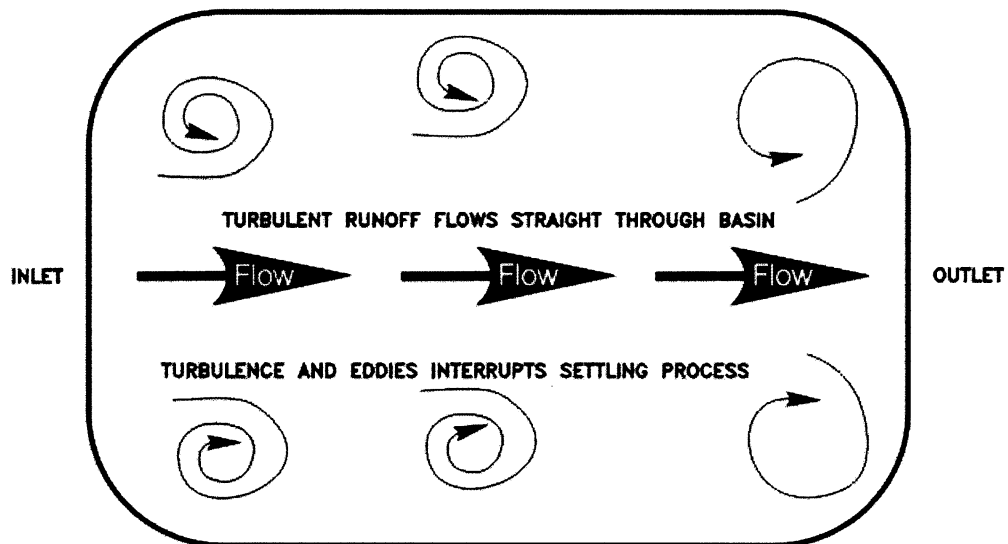
Check the embankment, spillways, and outlet for erosion damage, and inspect the embankment for piping and settlement. Make all necessary repairs immediately. Remove all trash and other debris from the riser and pool area.

FIGURE 3.30.1

## HOW A SEDIMENT BASIN WORKS



## HOW A SEDIMENT BASIN DOES NOT WORK



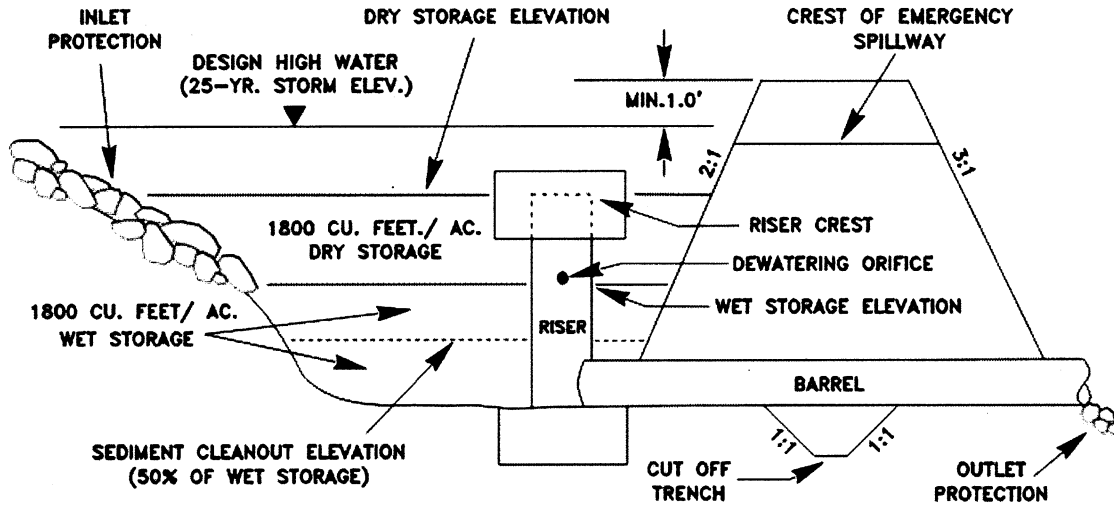
DURING PEAK STORM DISCHARGES THE VELOCITY AND ENERGY OF THE INFLOW ACROSS THE TRAP OR BASIN REMAINS TOO HIGH FOR MUCH SETTLING TO OCCUR.

FROM: SOIL FACTS NORTH CAROLINA COOPERATIVE EXTENSION

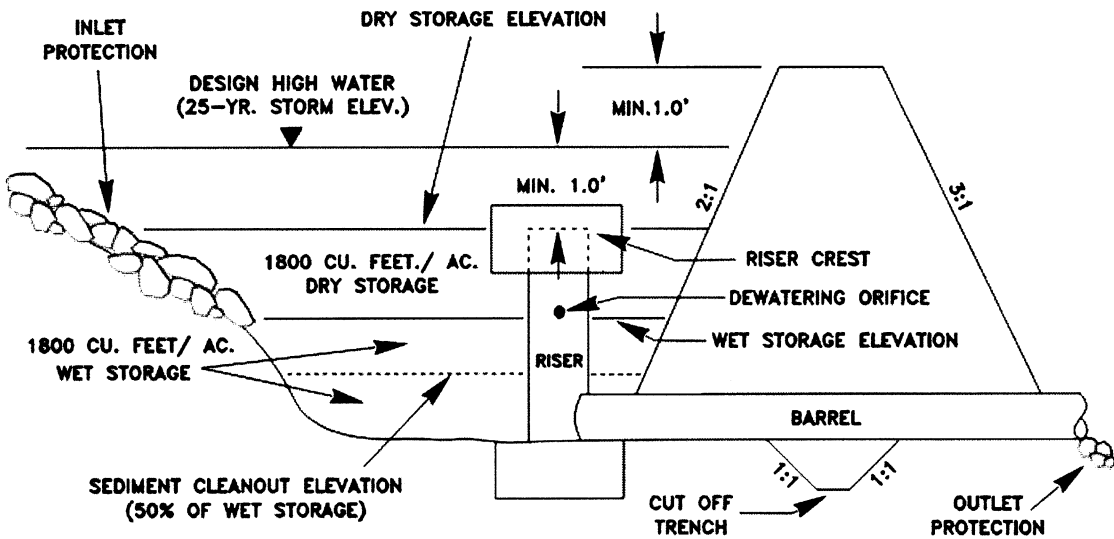


FIGURE 3.30.2

# SEDIMENT BASIN



## DESIGN ELEVATIONS WITH EMERGENCY SPILLWAY



## DESIGN ELEVATIONS NO EMERGENCY SPILLWAY

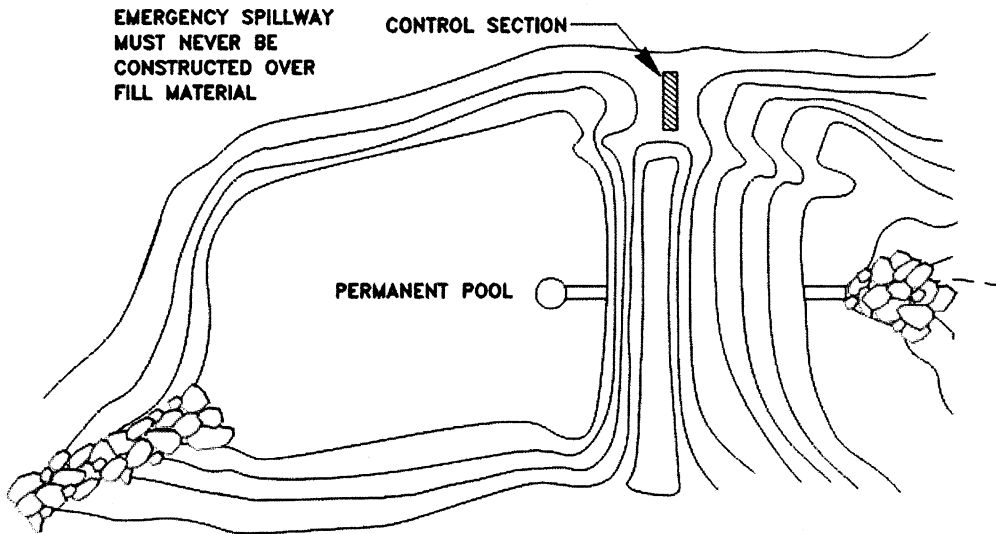
(NTS)

ADAPTED FROM: VA. DSWC

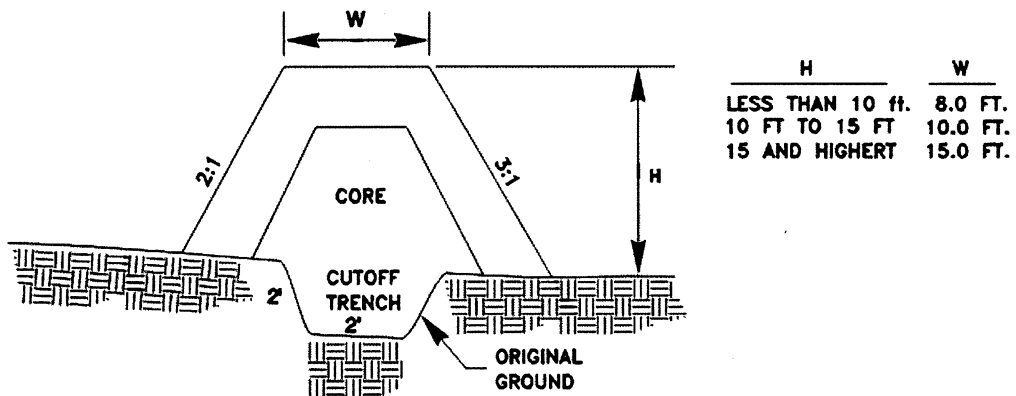
FIGURE 3.30.3

## *BASIN SCHEMATIC*

### *EMERGENCY SPILLWAY*



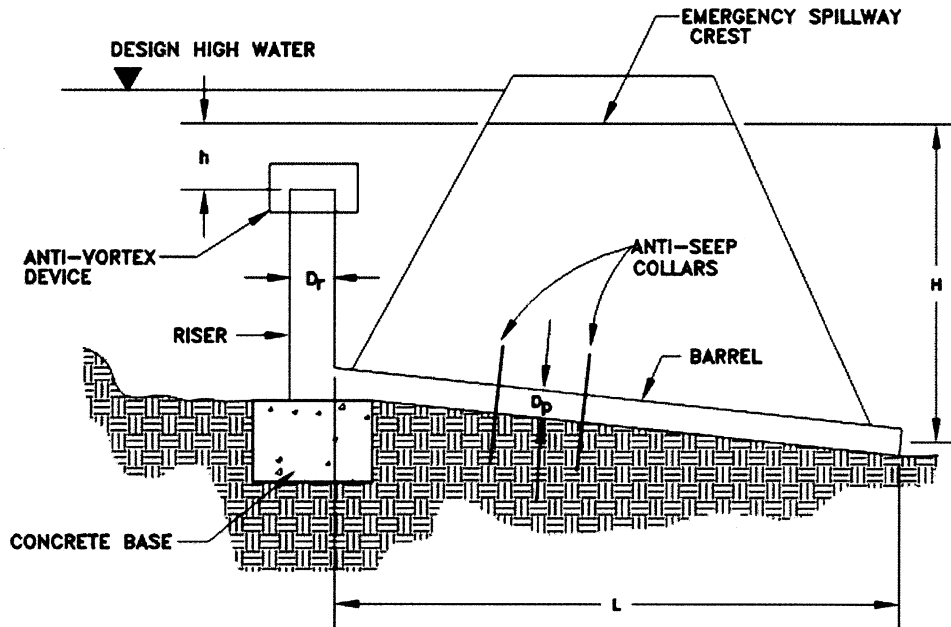
### *MINIMUM DIMENSIONS FOR SEDIMENT BASIN EMBANKMENTS*



SOURCE: VA. DSWC

FIGURE 3.30.4

# PRINCIPAL SPILLWAY DESIGN

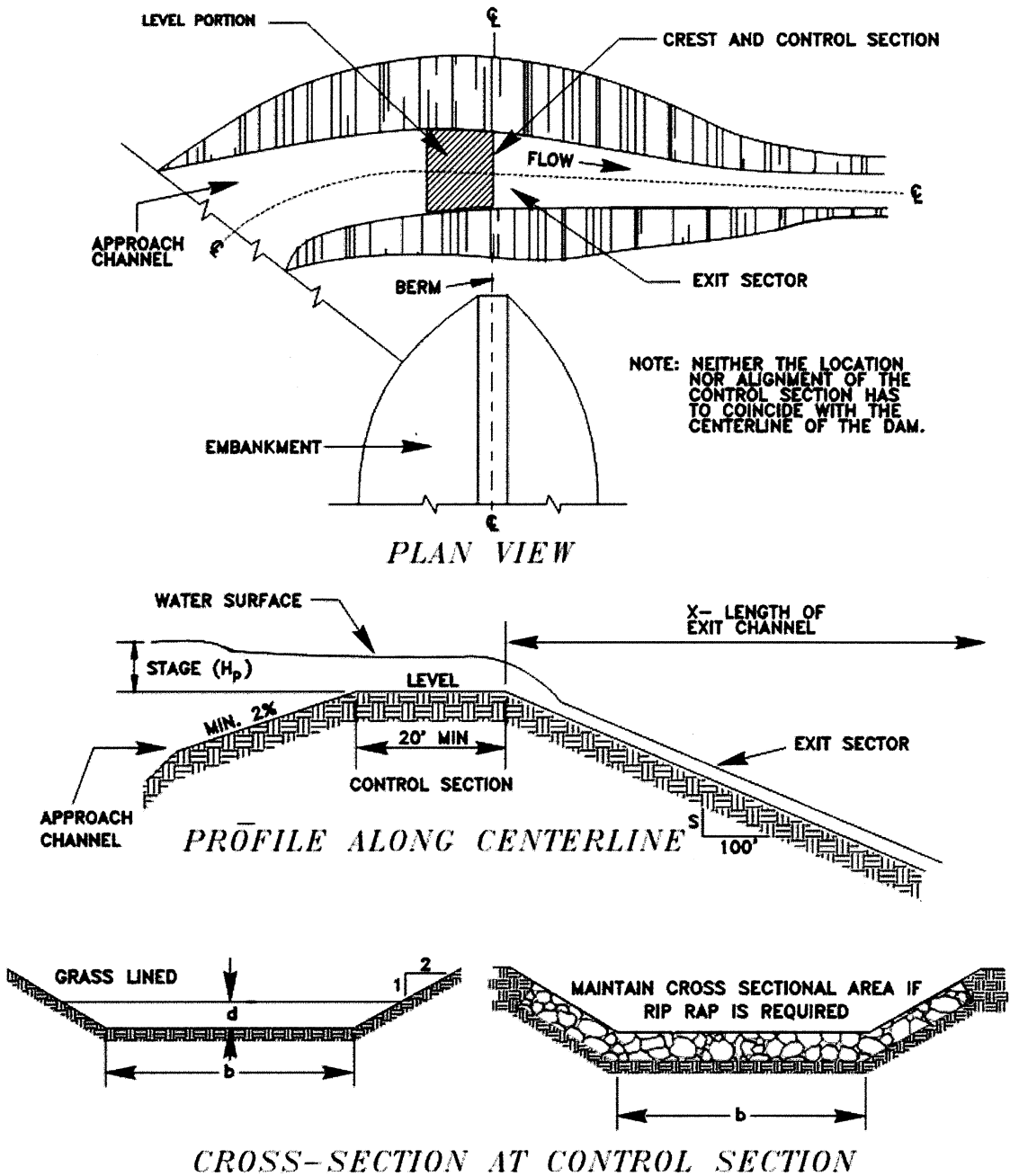


- $H$  = HEAD ON PIPE THROUGH EMBANKMENT
- $h$  = HEAD OVER RISER CREST
- $L$  = LENGTH OF PIPE THROUGH EMBANKMENT
- $D_p$  = DIAMETER OF PIPE THROUGH EMBANKMENT
- $D_r$  = DIAMETER OF RISER

SOURCE: VA. DSWC

FIGURE 3.30.5

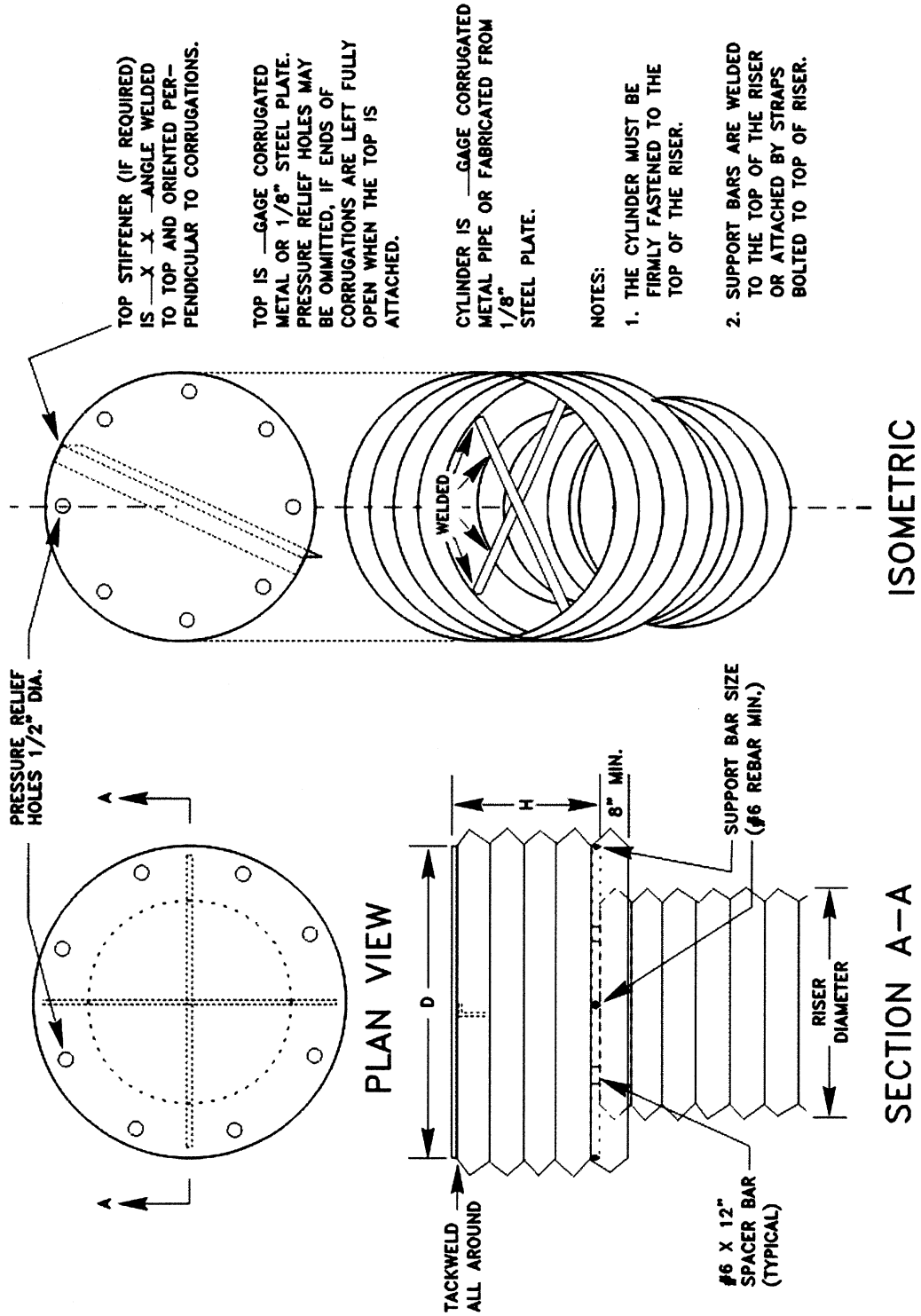
# EXCAVATED EARTH SPILLWAY



SOURCES: USDA-NRCS AND VA DNRC

FIGURE 3.30.6

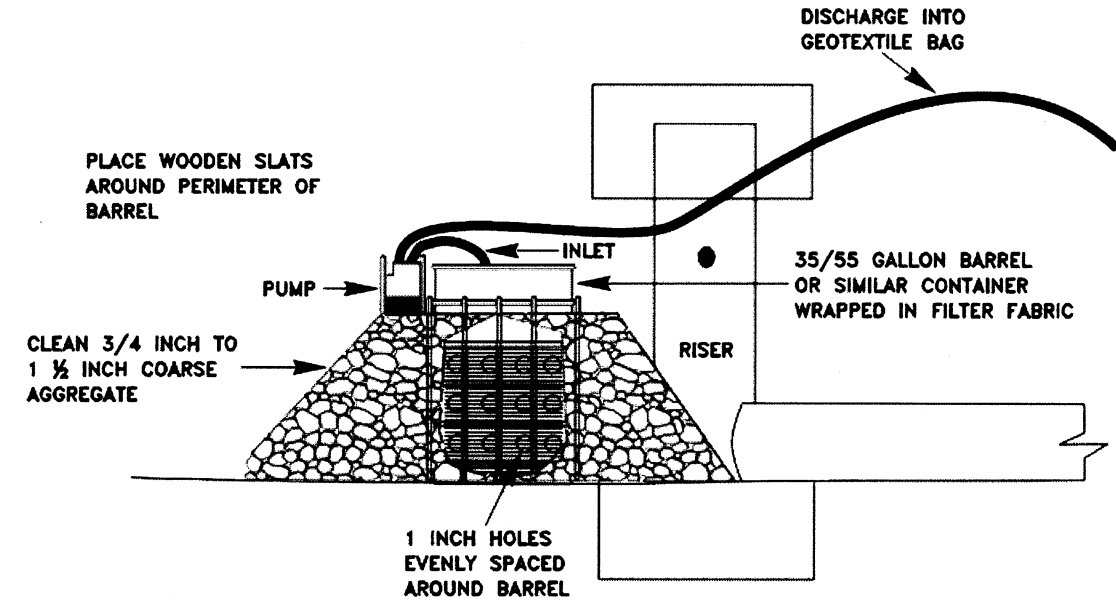
# TRASH RACK



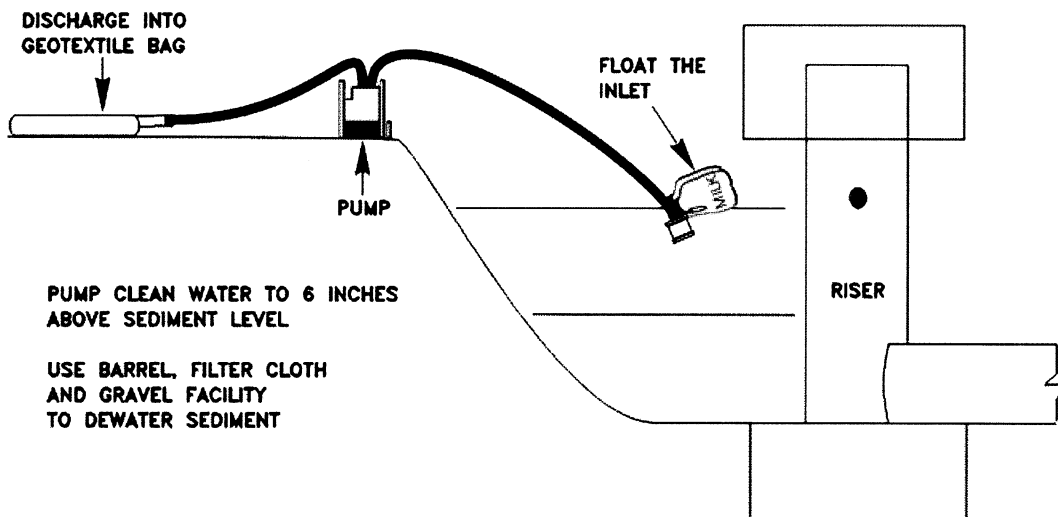
SOURCE: USDA-SCS AND VA DNRC

FIGURE 3.30.7

## SEDIMENT BASIN OR TRAP DEWATERING DEVICE



FROM PENNSYLVANIA EROSION AND SEDIMENT POLLUTION CONTROL PROGRAM MANUAL



# 3.33 - DROP INLET PROTECTION

---

**Introduction** A sediment barrier and/or an excavated impounding area around a storm drain drop inlet or curb inlet used to trap sediment before contaminated runoff enters a storm drainage system.

**Conditions Where Practice Applies** Where storm drain inlets are to be made operational before permanent stabilization of the corresponding disturbed drainage area.

Storm sewers that are made operational prior to stabilization of the associated drainage areas can convey large amounts of sediment to natural drainageways. In case of severe sediment loading, the storm sewer itself may clog and lose a major portion of its capacity. To avoid these problems, it is necessary to prevent sediment from entering the system at the inlets.

>>Storm sewers are installed to handle the runoff from their contributing drainage area and are sized to handle the flows from a particular size storm event. Installing any of these drop inlet protection practices reduces opening size of the inlet or severely restricts the hydraulic conditions entering the inlet, thereby reducing the capacity of the inlet to handle the excess flows from storm events. Design and install each of these practices with great care. It is highly recommended to use the 6" freeboard requirement whenever possible. Care must be taken not to create conditions where flooding will occur either when the inlet becomes clogged with sediment or debris and/or the top of the drop inlet protection is higher than the nearest low spot and storm flows bypass the inlet. This could lead to a cascading series of failures of other inlet protection, ending up with severe flooding to adjacent properties or severe erosion of fill slopes.

This practice contains several types of inlet barriers and traps that have different applications dependent upon site conditions and type of inlet. Plan developers are encouraged to investigate some of the commercially available products now on the market.

**General Design Criteria**

1. The drainage area should be no greater than 1 acre per inlet. The drainage area should be fairly flat with slopes of 5% or less and the area immediately around the inlet should not exceed a slope of 1%.
2. The inlet protection device shall be constructed in a manner that will facilitate clean out and disposal of trapped sediment and minimize interference with construction activities.
3. The inlet protection devices shall be constructed in such a manner that any resultant ponding of stormwater will not cause excessive inconvenience or damage to adjacent areas or structures.
4. For the inlet protection devices that utilize stone as the chief ponding/filtering medium, a range of stone sizes is offered The designer should attempt to get the greatest amount of "filtering" action possible

(by using smaller-sized stone), while not creating significant ponding problems.

5. In all designs that utilize stone with a wire-mesh support as a filtering mechanism, the stone can be completely wrapped with the wire mesh to improve stability and provide easier cleaning.
6. Filter Fabric may be added to any of the devices that utilize stone to significantly enhance sediment removal, but with a reduced flow capacity. The fabric, which must meet the physical requirements noted for “extra strength”, should be secured between the stone and the inlet (on wire-mesh if it is present). As a result of the significant increase in filter efficiency provided by the fabric, a larger range of stone sizes (up to gabion size) may be utilized with such a configuration.  
**Note:** Significant ponding will occur at the inlet if filter cloth is utilized in this manner.
7. If there is a possibility that ponding will occur, the top of the inlet protection must be at least six inches below the nearest low spot to insure sufficient freeboard. See Figure 3.33.2.
8. Remove any obstructions to excavating and grading. Excavate any sump area, grade slopes and properly dispose of soil.
9. The inlet grate should be secured to prevent seepage of sediment-laden water.
10. Ensure that weep holes in the inlet structure are protected by filter fabric and gravel.
11. Hardware cloth or wire mesh with ½-inch inch openings.
12. Filter fabric
13. Washed gravel ¾ inches to 4 inches in diameter. All cut slopes shall be 2:1 or flatter.

### ***Construction Specifications***

#### ***Silt Fence Drop Inlet Protection***

- a. Silt Fence shall conform to the specifications for “extra strength” and shall be cut from a continuous roll to avoid joints.
- b. For stakes, use 2 x 4-inch wood (preferred) or equivalent metal with a minimum length of 3 feet.
- c. Space stakes evenly around the perimeter of the inlet a maximum of 3-feet apart, and securely drive them into the ground, approximately 18 inches deep.
- d. To provide needed stability to the installation, frame with 2 x 4-inch wood strips around the crest of the overflow area at a maximum of 1 foot above the drop inlet crest.
- e. Place the bottom 12 inches of the fabric in a trench and backfill the trench with 12 inches of compacted soil. This limits this practice to unpaved areas.
- f. Fasten fabric securely by staples or wire to the stakes and frame. Joints must be overlapped to the next stake.
- g. It may be necessary to build a temporary dike on the downslope side of the structure to prevent bypass flow.
- h. It is recommended that a sediment trapping sump of 1 to 2 feet in depth with side slopes of 2:1 be provided.
- i. If the filter fabric becomes clogged it should be replaced immediately.



- j. Make sure that the stakes are firmly in the ground and that the filter fabric continues to be securely anchored.

**Gravel and Wire  
Mesh Drop Inlet  
Protection**

- a. Wire mesh shall be laid over the drop inlet so that the wire extends a minimum of 1 foot beyond each side of the inlet structure. Wire mesh with ½-inch openings shall be used. If more than one strip of mesh is necessary, the strips shall be overlapped.
- b. Coarse aggregate shall be placed over the wire mesh as indicated in the drawing. The depth of stone shall be at least 12 inches over the entire inlet opening. The stone shall extend beyond the inlet opening at least 18 inches on all sides.
- c. If the stone filter becomes clogged with sediment so that it no longer adequately performs its function, the stones must be pulled away from the inlet, cleaned and/or replaced.

*Note: This filtering device has no overflow mechanism; therefore, ponding is likely especially if sediment is not removed regularly. This type of device must never be used where overflow may endanger an exposed fill slope or flooding of adjacent properties. Consideration should also be given to the possible effects of ponding on traffic movement, nearby structures, working areas, adjacent property, etc.*

**Block and Gravel  
Drop Inlet  
Protection**

- a. Place concrete blocks lengthwise on their sides in a single row around the perimeter of the inlet, with the ends of adjacent blocks abutting. The height of the barrier can be varied, depending on design needs, by stacking combinations of 4-inch, 8-inch and 12-inch wide blocks. The barrier of blocks shall be at least 7½-inches high but no greater than 24-inches high.
- b. Wire mesh shall be placed over the outside vertical face (webbing) of the concrete blocks to prevent stone from being washed through the holes in the blocks. Wire mesh with ½-inch openings shall be used.
- c. Stone shall be piled against the wire to the top of the block barrier, as shown in the drawing.
- d. If the stone filter becomes clogged with sediment so that it not longer adequately performs its function, the stone must be pulled away from the blocks, cleaned and replaced.

**Pipe Riser  
Drop Inlet  
Protection**

- a. Each pipe riser must be constructed from steel plate that is cut to the dimensions of the drop inlet grate with an inch over lap on each side and a length of 12 inch corrugated metal pipe. Use a minimum of 10 gauge steel plate with a 12 inch hole cut in the center. The corrugated pipe is welded to the plate.
- b. Cut a series of one-inch holes in the corrugated pipe as shown on the drawings. Wire mesh with ½ inch openings can be wrapped around the outside of the pipe to prevent stone from being washed through the holes.

- c. Place a square piece of geotextile filter fabric at least one foot larger than the inlet dimensions around the riser and over the metal plate.
- d. Stone shall be piled to the top of the pipe, as shown in the drawing.
- e. If the stone filter becomes clogged with sediment so that it not longer adequately performs its function, the stone must be pulled away from the blocks, cleaned and replaced.
- f. This practice can be combined with the Excavated Drop Inlet Sediment Trap to increase the available storage.

***Excavated Drop Inlet Sediment Trap***

- a. The excavated trap shall be sized to provide a minimum storage capacity calculated at the rate of 3600 cubic feet per acre of drainage area. (if attainable). The trap should be not less than 1-foot nor more than 2-feet deep measured from the top of the inlet structure. Side slopes shall not be steeper than 2:1.
- b. The slope of the basin may vary to fit the drainage area and terrain. Observations must be made to check trap efficiency and modifications shall be made as necessary to ensure satisfactory trapping of sediment. Where an inlet is located so as to receive concentrated flows, such as in a highway median, it is recommended that the basin have a rectangular shape in a 2:1 (length/width) ratio, with the length oriented in the direction of the flow.
- c. Sediment shall be removed and the trap restored to its original dimensions when the sediment has accumulated to one-half the design depth of the trap. Removed sediment shall be deposited in a suitable area and in a manner such that it will not erode.
- d. If there is sufficient freeboard available this practice can be combined with other drop inlet protection devices such as Silt Fence or Pipe Riser.

***Gravel Curb Inlet Protection***

- a. Wire mesh with ½-inch openings shall be placed over the curb inlet opening so that at least 12 inches of wire extends across the inlet cover and at least 12 inches of wire extends across the concrete gutter from the inlet opening, as depicted in drawing.
- b. Stone shall be piled against the wire so as to anchor it against the gutter and inlet cover and to cover the inlet opening completely.
- c. If the stone filter becomes clogged with sediment so that it no longer adequately performs its function, the stone must be pulled away from the block, cleaned and replaced.

***Curb Inlet Protection with 2-inch x 4-inch Wooden Weir***

- a. Attach a continuous piece of wire mesh (30-inch minimum width x inlet throat length plus 4 feet) to the 2-inch x 4-inch wooden weir (with a total length of throat length plus 2 feet) as shown in the drawing. Wood should be “construction grade” lumber.
- b. Place a piece of approved “extra-strength” filter cloth of the same dimensions as the wire mesh over the wire mesh and securely attach to the 2-inch x 4-inch weir.

- c. Securely nail the 2-inch x 4-inch weir to the 9-inch long vertical spacers which are to be located between the weir and inlet face at a maximum 6-foot spacing.
- d. Place the assembly against the inlet throat and nail 2-foot (minimum) lengths of 2-inch x 4-inch board to the top of the weir at spacer locations. These 2-inch x 4-inch anchors shall extend across the inlet tops and be held in place by sandbags or alternate weight.
- e. The assembly shall be placed so that the end spacers are a minimum 1 foot beyond both ends of the throat opening.
- f. Form the wire mesh and filter cloth to the concrete gutter and against the face of curb on both sides of the inlet. Place coarse aggregate over the wire mesh and filter fabric in such a manner as to prevent water from entering the inlet under or around the filter cloth.
- g. This type of protection must be inspected frequently and the filter cloth and stone replaced when clogged with sediment.
- h. Assure that storm flow does not bypass inlet by installing temporary earth or asphalt dikes directing flow into inlet.

***Block and Gravel  
Curb Inlet  
Protection***

- a. Two concrete blocks shall be placed on their sides abutting the curb at either side of the inlet opening.
- b. A 2-inch x 4-inch stud shall be cut and placed through the outer holes of each spacer block to help keep the front blocks in place.
- c. Concrete blocks shall be placed on their sides across the front of the inlet and abutting the spacer blocks as depicted in the drawing.
- d. Wire mesh with ½-inch opening shall be placed over the outside vertical face (webbing) of the concrete blocks to prevent stone from being washed through the holes in the blocks.
- e. Coarse aggregate shall be piled against the wire to the top of the barrier as shown in the drawing.
- f. If the stone filter becomes clogged with sediment so that it not longer adequately performs its function, the stone must be pulled away from the blocks, cleaned and/or replaced.

***Gravel Bag  
Curb Inlet  
Protection***

- a. In general, gravel bags are used to create a small sediment trap upstream of inlets and are appropriate for gently sloping streets where ponded water will not endanger the public or cause property damage
- b. Flow from a severe storm should not overtop the curb.
- c. In areas of high clay and silts, use filter fabric and gravel as additional filter media.
- d. Use sandbags made of geotextile fabric (not burlap) and fill with uniform coarse aggregate material such as ½” rock or ¼” pea gravel. Do not use sand, as the bag must be porous.
- e. Place one or two layers of overlapping gravel bags, and pack them tightly together. A gap of one sandbag on the top row on either side of the inlet can serve as an overflow spillway for larger storms.
- f. Leave room upstream of barrier for water to pond and sediment to settle.

- g. Drape geotextile filter fabric over the barrier and place the aggregate to “filter” sediment from storm water. Small pipes (2” diameter or smaller) for additional safety can be placed through the gravel bag barrier if also covered by filter fabric.
- h. If the stone filter becomes clogged with sediment so that it not longer adequately performs its function, the stone must be pulled away from the blocks, cleaned and/or replaced

***Manufactured Drop  
Inlet Protection***

There are a number of new commercially available products on the market now. Some show great promise in providing excellent sediment control. However, great care must be taken when choosing a product as some have significant problems with their design.

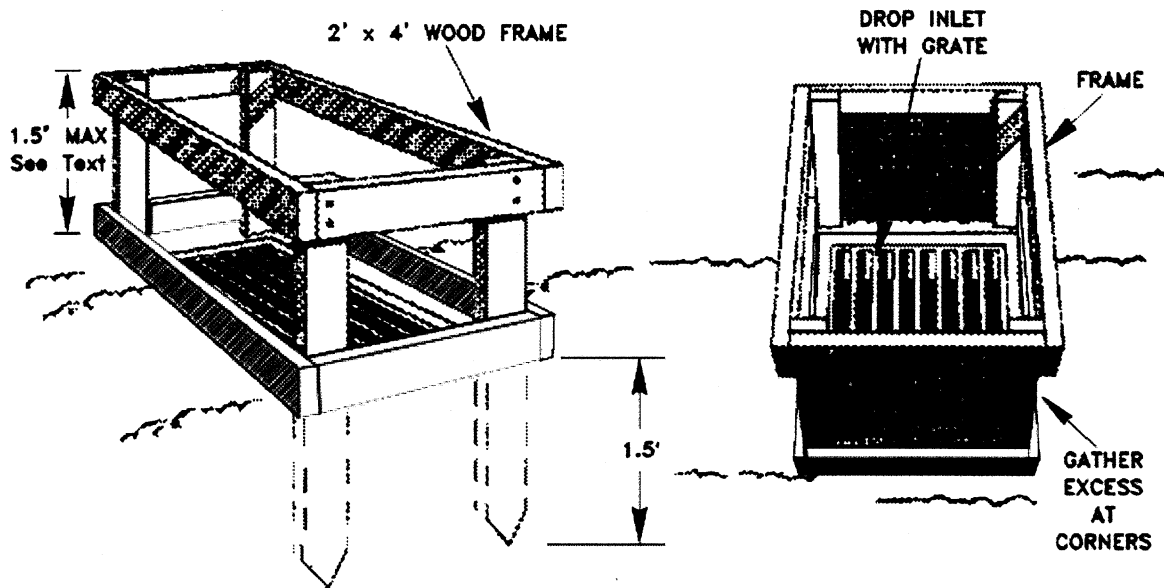
Do not install any practice that completely blocks the entrance of a drop inlet without some type of excess freeboard or adequate overflow. There are several curb inlet protections that block the inlet while providing several small holes for overflow. These holes are not large enough to pass larger storm events and can cause localized flooding. Some drop inlet protections cover the entire top of the inlet or are installed under the grate. These too have little overflow capacity and must be used judiciously. Practices that are placed inside inlets and out of sight are particularly easy to forget and become clogged and fail. In all cases the freeboard requirement must be met. While some of the products can work, great care must be taken to install correctly and to insure the design capacity of the inlet is not compromised.

***Maintenance***

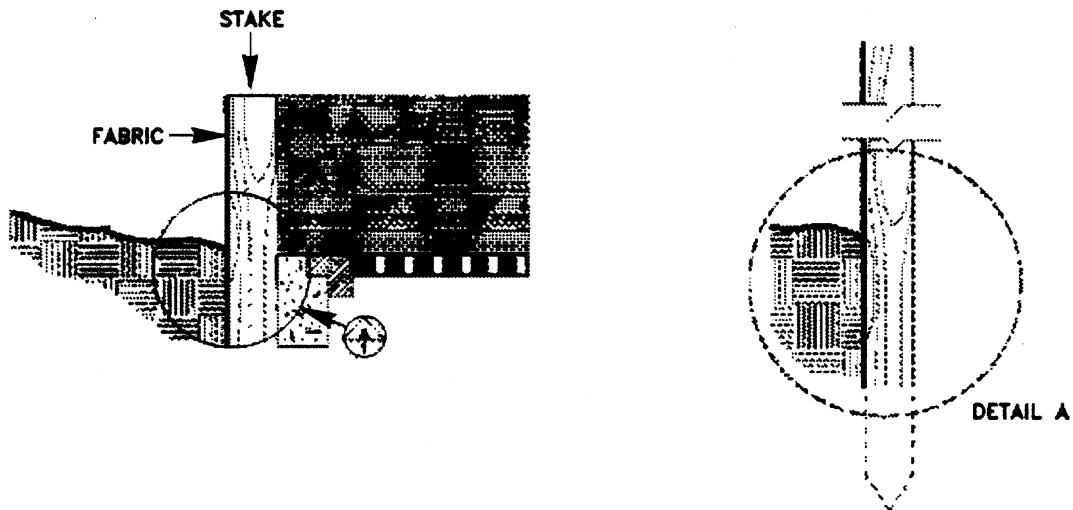
1. The structure shall be inspected after each .5" of rain and at least once a week and repairs made as needed. Construction traffic has a tendency to destroy these practices so frequent inspections are necessary.
2. Sediment shall be removed and the trap restored to its original dimensions when the sediment has accumulated to one half the design depth of the trap. Removed sediment shall be deposited in a suitable area and in such a manner that it will not erode.
3. Inlet protection should remain in place and operational until the drainage area is completely stabilized. Immediately stabilize the area disturbed by the installation and removal of the practice.
4. It is essential that maintenance be done to insure that structures do not fail, especially to prevent clogging. Failure of one practice can create a domino effect of failures, with the potential of severe flooding of adjacent properties.

FIGURE 3.33.1

# SILT FENCE DROP INLET PROTECTION



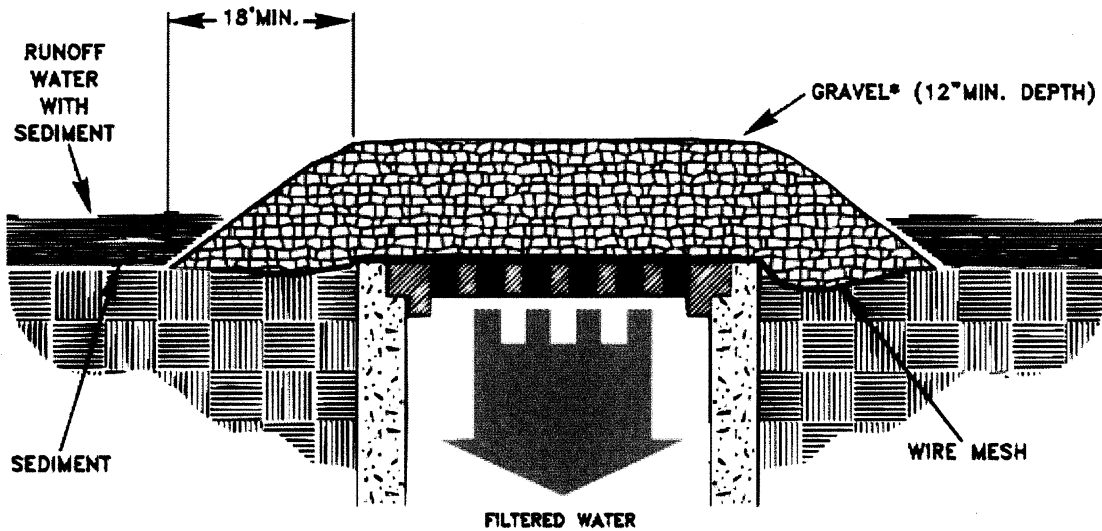
PERSPECTIVE VIEWS



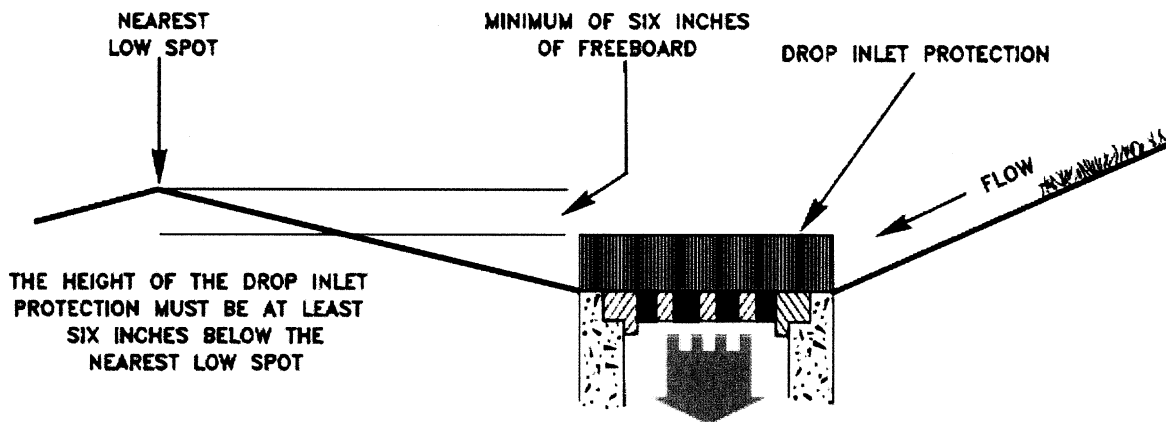
SPECIFIC APPLICATION

FIGURE 3.33.2

## GRAVEL AND WIRE DROP INLET PROTECTION



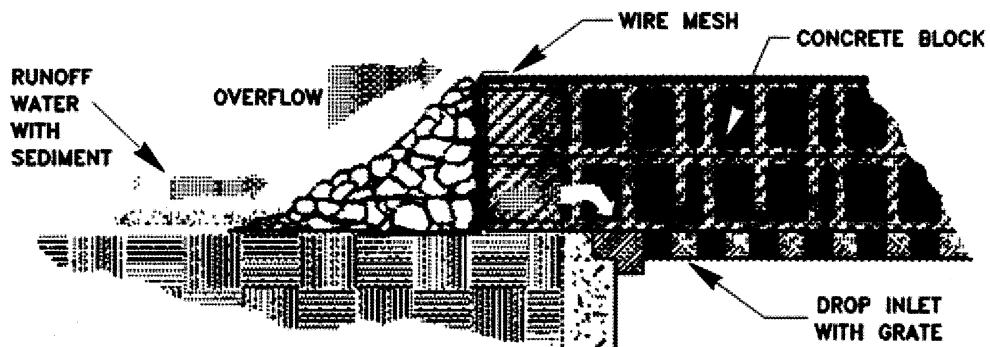
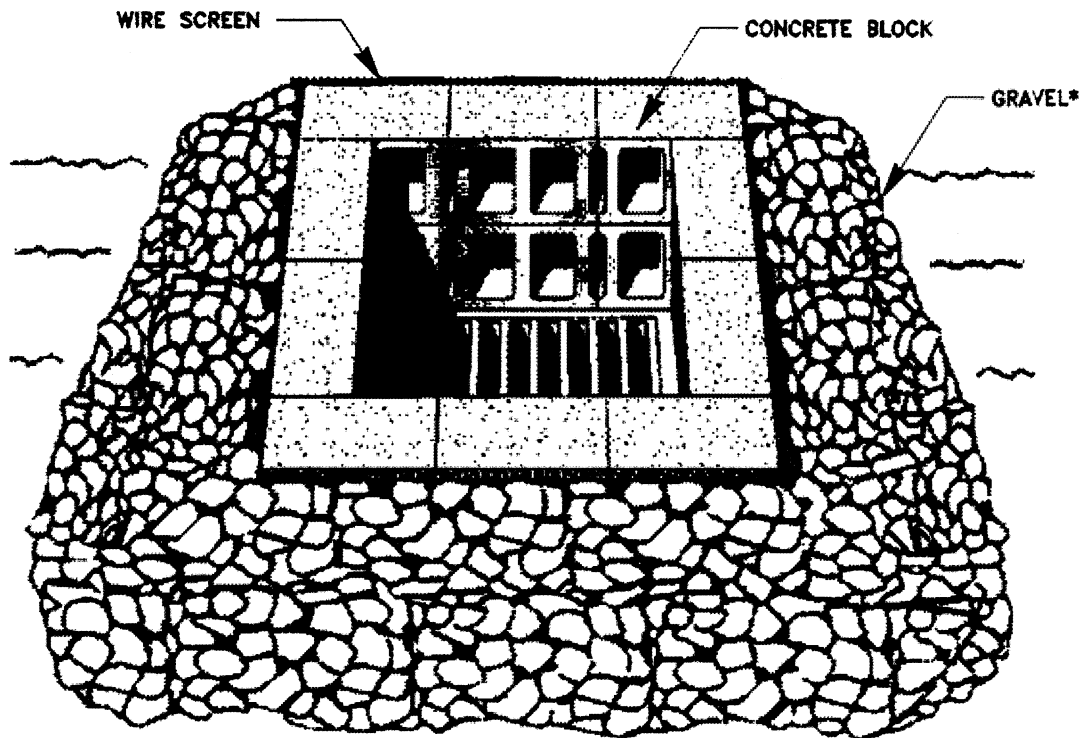
## FREEBOARD REQUIREMENTS FOR ALL DROP INLET PROTECTION



\* GRAVEL SHALL BE CLEAN 3/4" TO 2" COARSE AGGREGATE

FIGURE 3.33.3

# BLOCK AND GRAVEL DROP INLET SEDIMENT FILTER

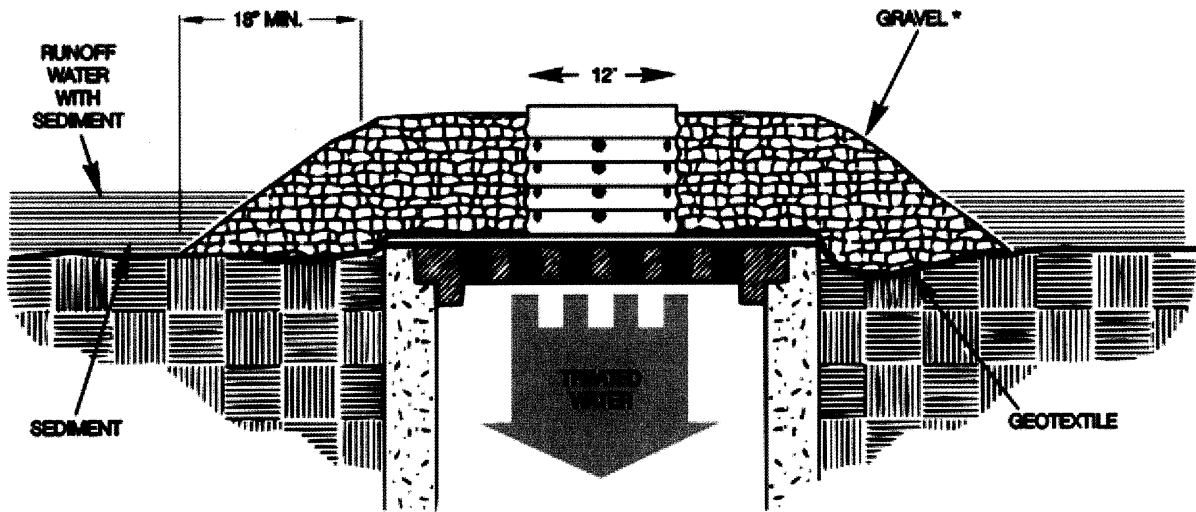


## SIDE ELEVATION

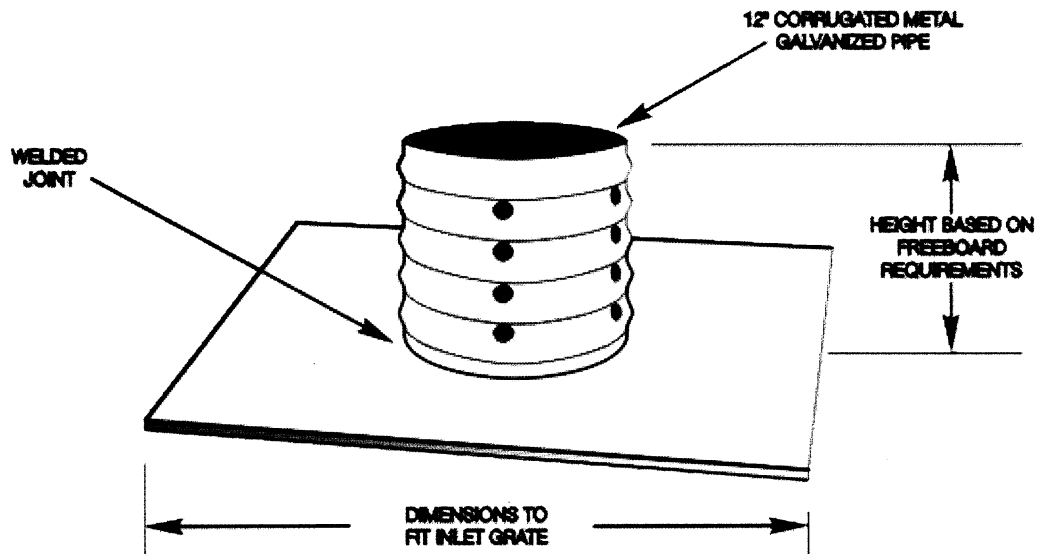
\* GRAVEL SHALL BE CLEAN 3/4" TO 2" COARSE AGGREGATE

FIGURE 3.33.4

# PIPE RISER AND GRAVEL DROP INLET PROTECTION



*SIDE ELEVATION*



*PERSPECTIVE VIEW*

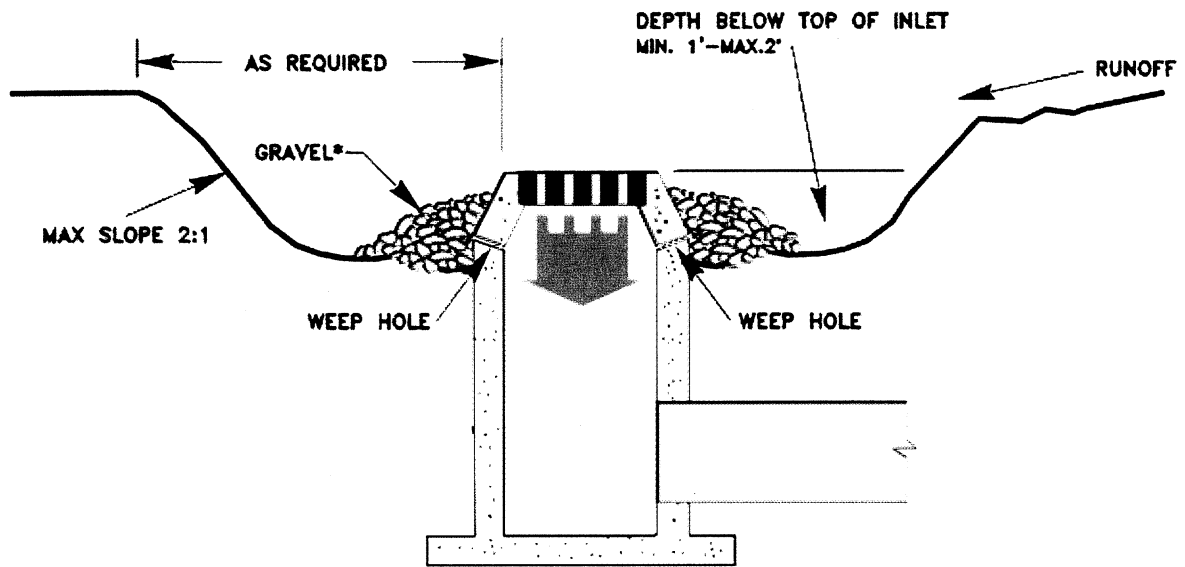
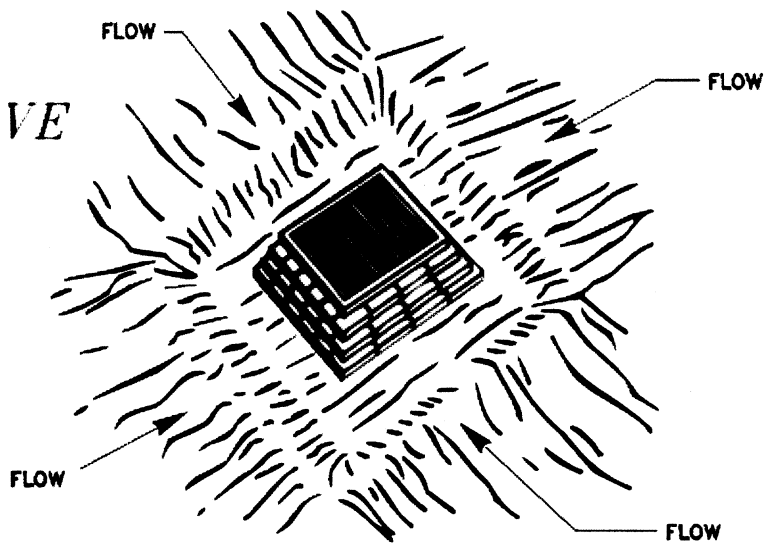
\* GRAVEL SHALL BE CLEAN 3/4" TO 2" COARSE AGGREGATE



FIGURE 3.33.5

# EXCAVATED DROP INLET PROTECTION

PERSPECTIVE  
VIEW

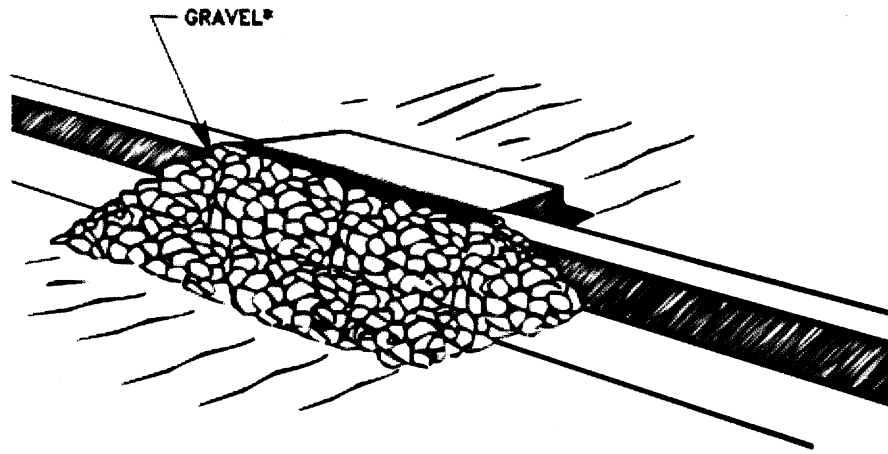


SIDE  
ELEVATION

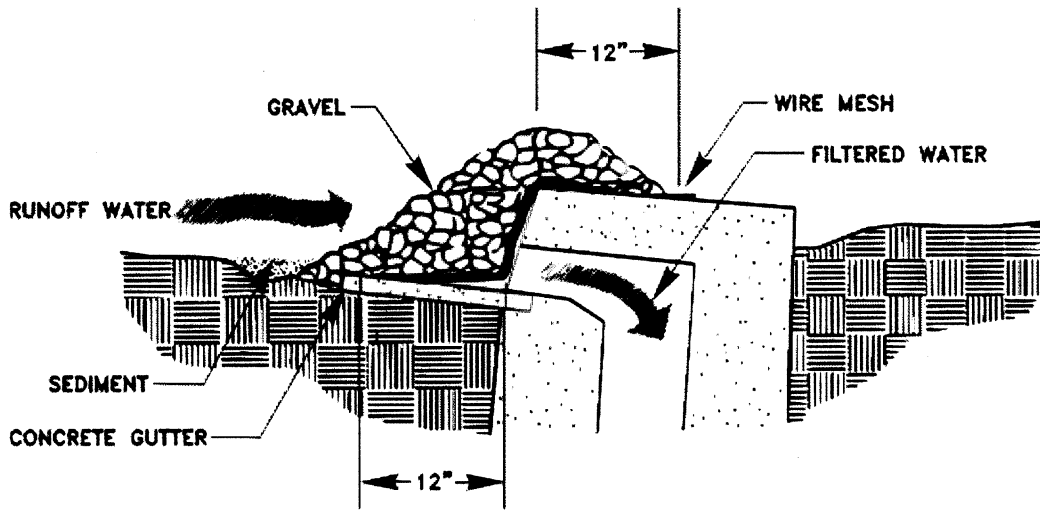
\* GRAVEL SHALL BE CLEAN  
3/4" TO 2" COARSE AGGREGATE

FIGURE 3.33.6

# GRAVEL AND WIRE CURB INLET PROTECTION



PERSPECTIVE  
VIEW

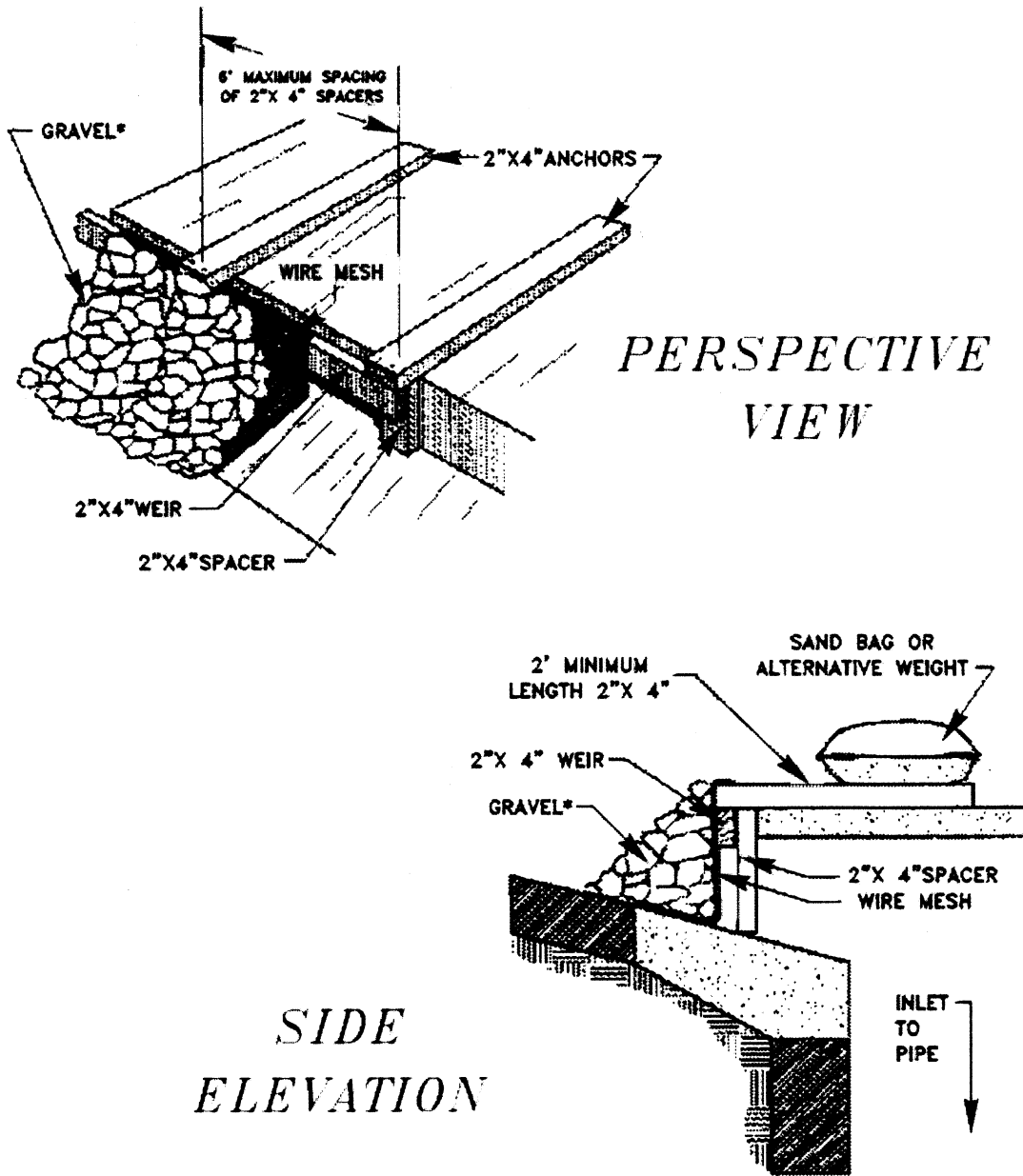


SIDE  
ELEVATION

\* GRAVEL SHALL BE CLEAN 3/4" TO 2" COARSE AGGREGATE

FIGURE 3.33.7

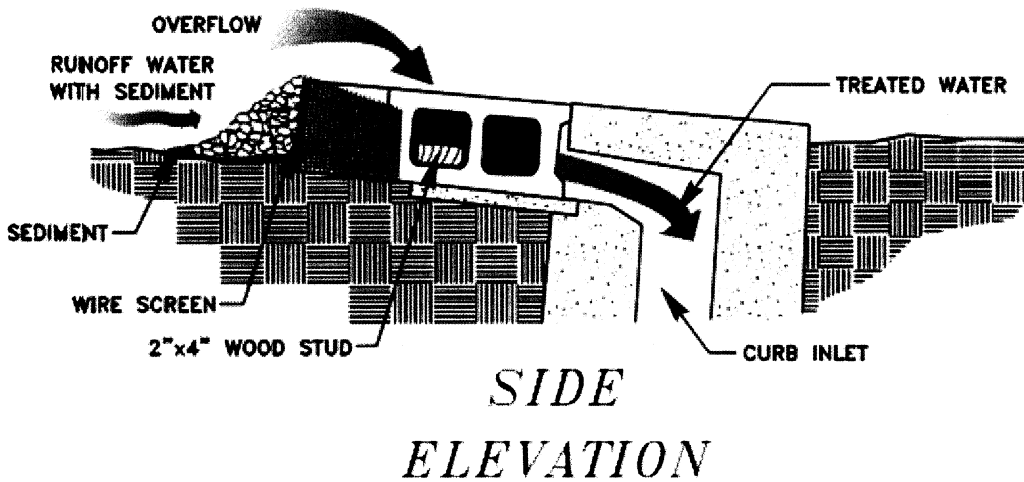
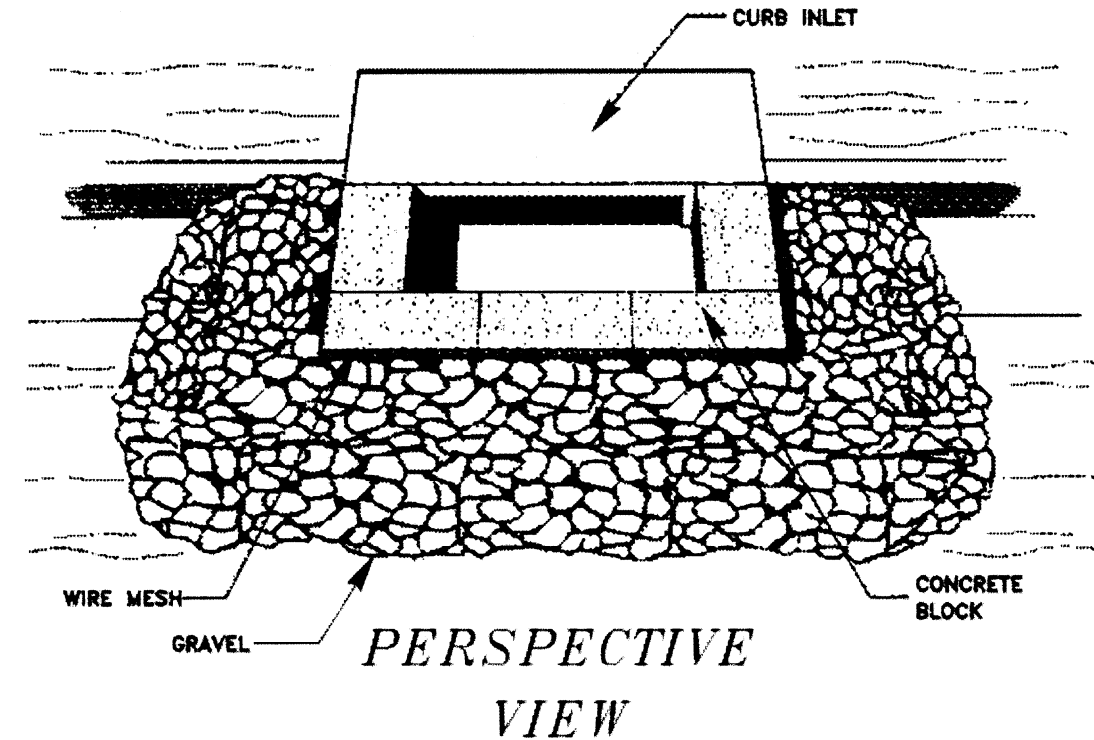
# CURB INLET PROTECTION WITH 2" x 4" WOODEN WEIR



\* GRAVEL SHALL BE CLEAN 3/4" TO 2" COARSE AGGREGATE

FIGURE 3.33.8

# BLOCK & GRAVEL CURB INLET PROTECTION



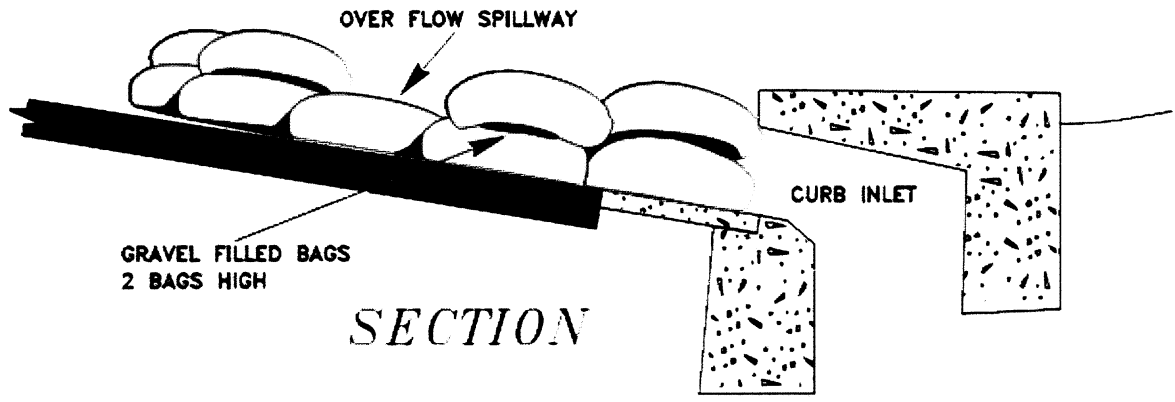
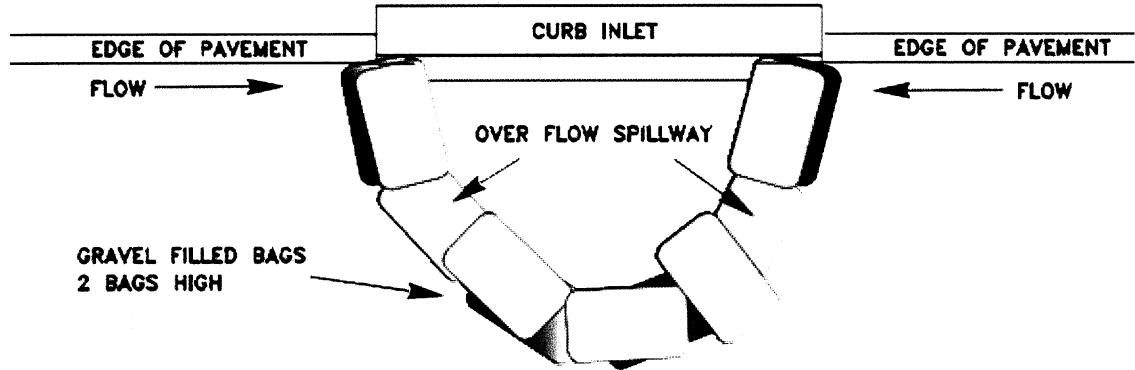
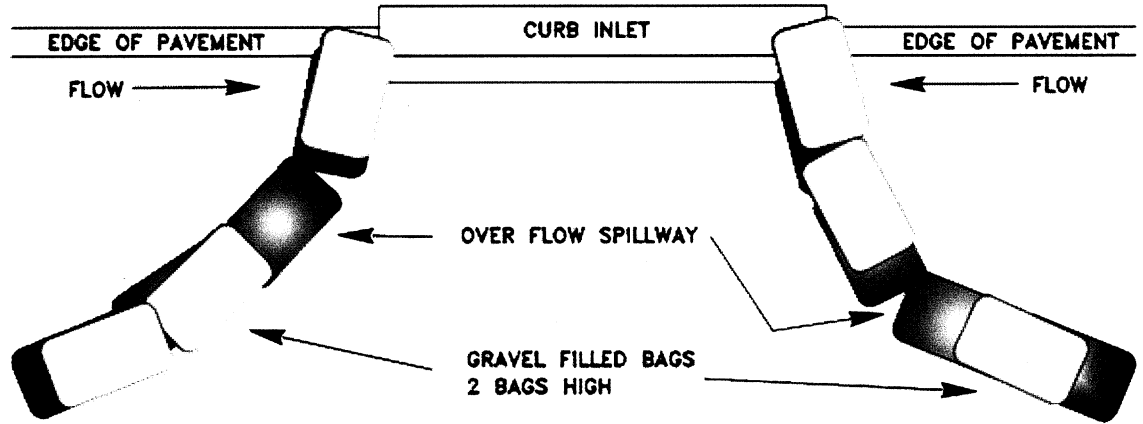
### SPECIFIC APPLICATION

THIS METHOD OF INLET PROTECTION IS APPLICABLE AT CURB INLETS WHERE AN OVERFLOW CAPABILITY IS NECESSARY TO PREVENT EXCESSIVE PONDING OR FLOODING.

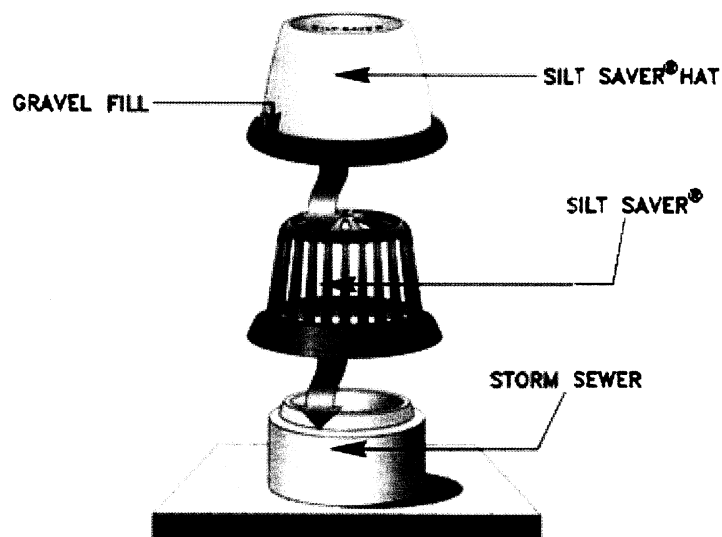
▪ GRAVEL SHALL BE CLEAN 3/4" TO 2" COARSE AGGREGATE

FIGURE 3.33.9

# GRAVEL BAG CURB INLET PROTECTION

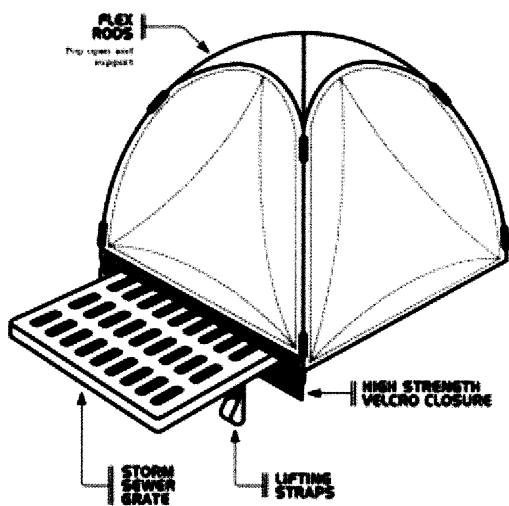


# COMMERCIAL INLET PROTECTION

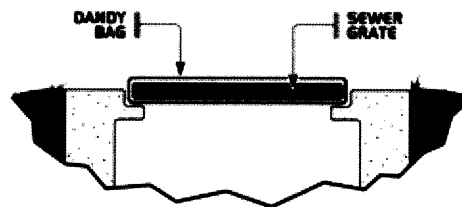
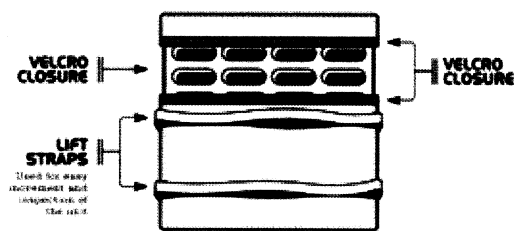


SILT SAVER<sup>®</sup>  
FRAME AND FILTER ASSEMBLY

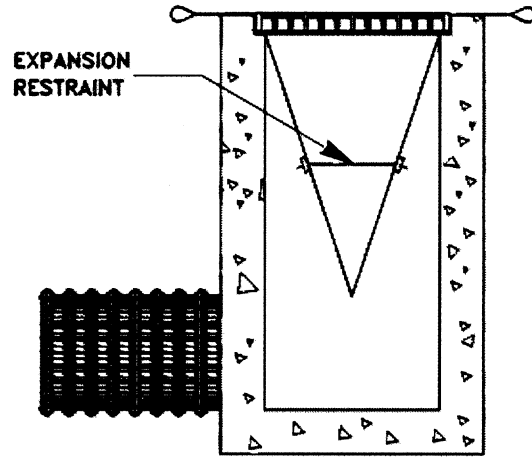
## ▶ DANDY POP ◀



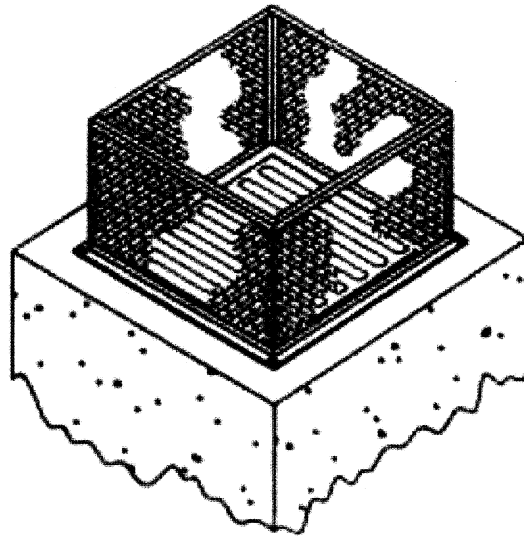
## ▶ DANDY BAG ◀



# COMMERCIAL INLET PROTECTION



*SILT SACK™*



*VERTI-PRO™*

# 3.35 - ACCESS ROAD/ LOW VOLUME ROAD/DRIVEWAY

---

## ***Introduction***

Access roads and driveways are a major source of sediment in the State of West Virginia. Roads can dramatically change the hydrologic conditions of the immediate watershed. Roads that are improperly designed, constructed and stabilized can cause significant erosion and produce vast quantities of sediment. Common problems with roads are:

1. Inadequate number and size of culverts.
2. Road grade too steep.
3. Road surface not stabilized.
4. Poor soil conditions.
5. Poor drainage.
6. Poor stream crossings.
7. Cuts and fills too steep causing slips.

Since roads are typically long-term features, cutting costs during the construction phase almost always costs more in the long run as maintenance costs will be significantly higher on improperly designed and constructed roads.

To control sediment from roads it is necessary to practice aggressive erosion control. The single most important thing to do when designing and building a road is to control the water. Running water more than a few hundred feet down a road will cause long-term erosion and increase maintenance costs.

It is important that concentrated upslope water from streams or drainageways is directed immediately across the road with a culvert. Adequately sized and stabilized ditches to catch minor hillside runoff must also be constructed. The goal is to maintain the existing hydrologic conditions as much as possible by installing adequate numbers of cross culverts.

## ***Conditions Where Practice Applies***

Wherever low volume access roads are built. This practice can apply to any type of dirt or gravel road outside the Department of Transportation's road system.

## ***Planning.***

Planning and location are two of the more important aspects of road development and takes considerable time and effort. Good planning upfront can forestall problems later on.

1. You will need topographic maps, soil surveys and soil maps, and a device to determine grade. Roads should not be built on some soils. Check with the Natural Resources Conservation Service for information on soils. Review available information and



- consult with professionals as necessary to help identify erodible soils and unstable areas, and to locate appropriate road surface materials.
2. Fit the road to the topography by locating roads on natural benches and following natural contours. Avoid long, steep road grades and narrow valleys.
  3. If possible use switchbacks where it is impossible to construct a road below the maximum grade.
  4. If it is necessary to construct in steep terrain break the road grade as much as possible by alternating steep section with flatter sections. Sometimes the road grade can be reversed which will shorten slope length and reduce the number of culverts, water bars and broad-based dips.
  5. Locate roads on stable geology, including well-drained soils and rock formations that tend to dip into the slope. Avoid slumps and slide prone areas characterized by steep slopes, highly weathered bedrock, clay beds, concave slopes, hummocky topography, and rock layers that dip parallel to the slope.
  6. Avoid wet areas, including moisture laden or unstable toe slopes, seeps, wetlands, and natural drainage channels. Ridge tops can be good places for a road as long as proper drainage can be constructed. Be aware that conditions may change when constructing in the dryer times of the year. Be prepared to add culverts after construction when hidden springs and streams start back up in the winter and spring.
  7. Avoid crossing streams, if practical. If unavoidable, look for the best places to cross, considering the following.
    - Always cross at right angles.
    - Cross at points where the stream is narrow and the stream banks are stable.
    - Minimize the number of crossings.
    - Leave a buffer zone of undisturbed ground between the road and streambed, where the road runs parallel to the stream.
    - Divert water from road with a diversion or water bar to prevent water running directly into the stream.
  8. If possible build roads on the drier south or west facing slopes. Clear trees to allow the sun to hit the road as much as possible.
  9. Stabilization of all disturbed soil must take place as quickly as possible. Seed and mulch all cut and fill slopes and shoulders within seven days of reaching final grade. Stabilize the ditches as the line and grade is finalized.
  10. Stabilization should occur as the road is constructed. Build the road in sections. Initiate stabilization on a finished section prior to moving to the next section. Finish road crossings and section nearest the creek immediately. Do not rough grade the entire road and then come back to the beginning to start restoration and stabilization. Quick stabilization of the disturbed area will greatly enhance any sediment control.

## Mapping

Using the above information, locate control points (areas where you can and can't build a road) such as rock outcrops, extreme slopes, slip prone areas, poor soils, streams, ridges, saddles, hillside benches, property lines, access points and end point on a topo map. Lay the road out on a contour map with a pencil hitting or missing these control points. Calculated the grade of the road, attempting to keep it below 10 percent. This will show where sections are too steep and the road needs to be moved. Grades over 12 percent for more than a few hundred feet should be avoided if possible. Change the location of the road or break the grade to maintain the optimum grade. After all the changes are made it is time to go to the field to verify the site conditions.

Next mark on the map the tentative locations of the culverts using this formula:

$$400/\% \text{ grade} + 75' = \text{culvert spacing}$$

Do not space culverts more than 300' apart.

In field walk the centerline. Locate the control points and flag the centerline by tying plastic ribbon at eye level. Using an Abney Level or Clinometer, check the actual grades from ribbon to ribbon, back checking each run. Adjust the grade where the road exceeds 12 percent

Look for wet spots, springs and water features missed because of the topo map's scale. Move the centerline to miss any unmapped features or add culverts where needed. It may be necessary to move most of the culverts to make it easier to install them and to correctly locate where concentrated flows cross the road. If bedrock is found, the culvert can be moved down hill even if it exceeds the spacing requirement. Sometimes it is advantageous to add a culvert immediately above a steep section to keep upslope drainage from entering a high velocity section.

Approaches to public roads need an Entrance Permit from the Division of Highways. Do not allow water to run onto public roads, divert with berm or water bar. The BMP for STABILIZED CONSTRUCTION ENTRANCE can be used for permanent access roads.

## ***Design and Construction Criteria***

There are several critical design criteria that must be met if the long-term stability of an access road is to be maintained.

The key criteria are:

1. Cross-section
2. Road Grade
3. Ditch line protection
4. Water Control

5. Stream Crossing
6. Stabilization
7. Sediment Control

One of the most important design parameters is to keep the road grade as flat as possible. Any road grade over 10 percent can cause difficulties with surface stability, washing off of the gravel surface, and gully formation. If steeper sections (such as to get over a rocky section) are necessary install more culverts or break the grade, or add water bars.

**Road Cross-Sections** Five road cross-sections typically are used in road construction: crowned fill, crowned turnpike, outslope, inslope with ditch, and crowned and ditched (Figure 3.35.1).

The choice of which cross-section to use depends on the drainage needed, soil stability, slope, and the expected volume of traffic on the road. You can use these cross-sections in combination as the terrain changes or as drainage problems are encountered.

- Crowned fill section is for use on flat ground where water standing on a road surface may be a problem.
- Outslope section is for use on moderate slopes for low volume roads and stable soils. Outsloping can be more dangerous in wet and snowy weather. Broad-based dips and water bars can be used on this cross-section rather than culverts.
- Inslope with ditch section is for use on steep hills, areas with fine textured soils, winter logging, and areas where drainage is necessary.
- Crowned and ditched section is for high volume roads on steep side hills.

**Road Grade:** Road grade is the single most important factor in planning a low volume road. Road grades must be kept to a minimum. If possible do not exceed 10 percent. The maximum for short distances can be 12 percent but it will be harder to keep gravel in place, ditch lines are harder to stabilize and culverts, water bars and broad-based dips are harder to install. Ruts form easier and the higher runoff velocities will erode them faster.

Grade is expressed as a percent and can be determined as follows.

percent slope = rise in vertical feet divided by the horizontal run in feet.

**Ditch line Protection:** Recommended ditch line protection can be based on the grade as follows:

1. Less than 3 percent - grassed
2. 3 – 8 percent - grass with rolled erosion control products

3. Greater than 9 percent - riprap or equivalent geotextile (must submit manufacturers specifications and calculated velocities).

If the flows are significant the protection should be based on an engineering study of the particular characteristics of the waterway and soils.

For more information see DIVERSIONS.

**Water Control Structures:** The construction of roads can radically alter the hydrologic regime of the local watershed. By installing structures, devices and measures to reestablish or approximate the original flow paths, erosion and road maintenance can be almost eliminated. Conversely, failure to provide adequate flow management can create very serious erosion. In most situations, providing appropriate measures is straightforward and simple. Proper planning and the flexibility to address onsite problems are necessary to control storm flows and will make it easier to protect the investment of building the road and improve water quality.

The single most common problem on low volume roads is the lack of culverts. Culverts allow the upslope water to cross the road at right angles and without coming into contact with the road surface. Maintaining the natural flow path is critical to reducing erosion on roads. Streams of any size should NEVER be allowed to run down a road. The road surface can wash away and ditch lines can be destroyed.

**Culverts:** There are two types of culverts on roads. One is used to pass upslope perennial and intermittent streams across the road. The other is sometimes called a cross-drainage culvert and is used to move lesser amounts of water from springs, seeps and upslope runoff across the road.

Culverts must be installed at each stream/waterway crossing and periodically along the roadway. Cross-drainage culverts are spaced apart at least 125' and no more than 300'.

#### **400/percent grade + 75' = culvert spacing**

Install OUTLET PROTECTION at each culvert. Install a headwall or similar device at each culvert.

The minimum size should be 12 inches. The culvert chart (Table 3.35.1) can be used to size culverts with a drainage area up to 600 acres.

The minimum grade should be 1 percent and culverts should be installed from 25 to 45 degrees to the centerline of the ditch to minimize turbulence at the inlet.

Culverts must extend at least one foot beyond the toe of the fill. Do not discharge onto the side of a road fill. If not possible, design OUTLET PROTECTION using grouted riprap .

Firmly backfill the trench and around culvert with fine-grained material, taking care to create good contact underneath the pipe. Cover the top of the culvert with at least 12 inches of fill, more if heavy loads are anticipated on the road.

Drainage Area (Acres)	Table 3.35.1 Average Slope of Watershed			
	1%	4%	8%	16%
	Culvert Size			
1 - 25	24	24	30	30
26 - 50	24	30	36	36
51 - 100	30	36	42	48
101 - 150	30	42	48	48
151 - 200	36	42	48	54
200 - 250	42	48	60	60
251 - 300	42	48	60	60
301 - 350	42	48	60	60
351 - 400	42	54	60	60
401 - 450	42	54	60	72
451 - 500	42	54	60	72
501 - 550	48	60	60	72
551 - 600	48	60	60	72
601 - 640	48	60	72	72

**Broad-based Dips:** Broad-based dips (Figure 3.35.3) were developed at the Fernow Experimental Forest in West Virginia to control surface water on Forest Service roads. Under the right conditions and correctly constructed they are an excellent method of controlling runoff.

Regular traffic can easily traverse them and once installed require little maintenance. However, they are almost impossible to install on steep roads and difficult to maintain in poor soil conditions. They are easily installed on roads with less than 10 percent grade and where the subgrade material is suitable:

Broad-based dips cannot be used to pass continuous flowing water across the road or under extended damp conditions such as where springs are located. Culverts are required in these situations.

Spacing for Broad-based Dips is the same as culverts.

$$400/\text{percent grade} + 75 \text{ feet} = \text{dip spacing}$$

Do not space broad-based dips more than 300 feet apart.

**Water Bars:** Water bars (Figure 3.35.4) are a small berm and swale construction across a road to direct surface water off the road and into a stabilized vegetated area. Water bars are useful on infrequently used or abandoned roads.

Water bars are installed similarly to TEMPORARY RIGHT-OF-WAY DIVERSIONS. They should be installed at an angle (30 to 45 degrees) across the road. The water bar must extend across the entire width of the road. They should never dam the water but should intercept and divert the water off the road. The discharge point should be fully open and protected from erosion and discharge to a stable vegetated area or undisturbed forest flow.

As with the broad-based dip it should not be used where there is a continuous flow of water such as a stream or spring or seep. It is very important the water bar not create erosion over the road fill. To prevent erosion use RIP RAP or a RECP.

The spacing for water bars is the same as for broad based dip.

**Turnouts:** Turnouts are extensions of the ditch line into a vegetated area or natural waterway. Sometimes the ground drops off either side of the road and a culvert can't be installed. A turnout can be constructed to transfer water away from the roadway into a natural water way or onto a flat well-vegetated area. Turnouts are similar to LEVEL LIP SPREADERS but for smaller quantities of flow. It is important that a dam isn't formed at the end that can erode and the turnout is PERMANENT SEEDED immediately upon completion.

It is possible to install a SEDIMENT TRAP at the end of many turnouts.

**Stream Crossings:** See the specification under INSTREAM CONSTRUCTION BMPS for more information. Bridges are always preferable to culverts when crossing a perennial stream.

**Culverts installed for permanent applications must be designed at a minimum to pass the peak discharge from a ten-year/24-hour storm with out causing upstream backup and downstream scour.**

**Sediment Control:** During construction sediment control will consist of installing appropriate sediment control devices such as BRUSH BARRIERS, SILT FENCE, SUPER SILT FENCE and SEDIMENT TRAPS. (Figure 3.35.2)

On extreme slopes it may be impossible to install anything other than a BRUSH BARRIER or SILT FENCE. Sediment control can be accomplished by following the recommendations in this BMP and by rapid restoration and stabilization according to the PERMANENT SEEDING specification. Recognizing these difficulties, DEP will allow lesser sediment control if offset by an aggressive stabilization schedule shown in the SWPPP.

Critical areas such as stream crossings will still require appropriate sediment control while in other areas smaller traps/sumps may be used. Alternative sediment controls can be pursued or modifying existing one

may be necessary. One place is at the head of most of the side ditch culverts. A small sediment trap/sump can be installed here.

This BMP does not cover specifications for earth moving nor sets out standards other than the basics covered above.

For more information on construction see the following drawings.

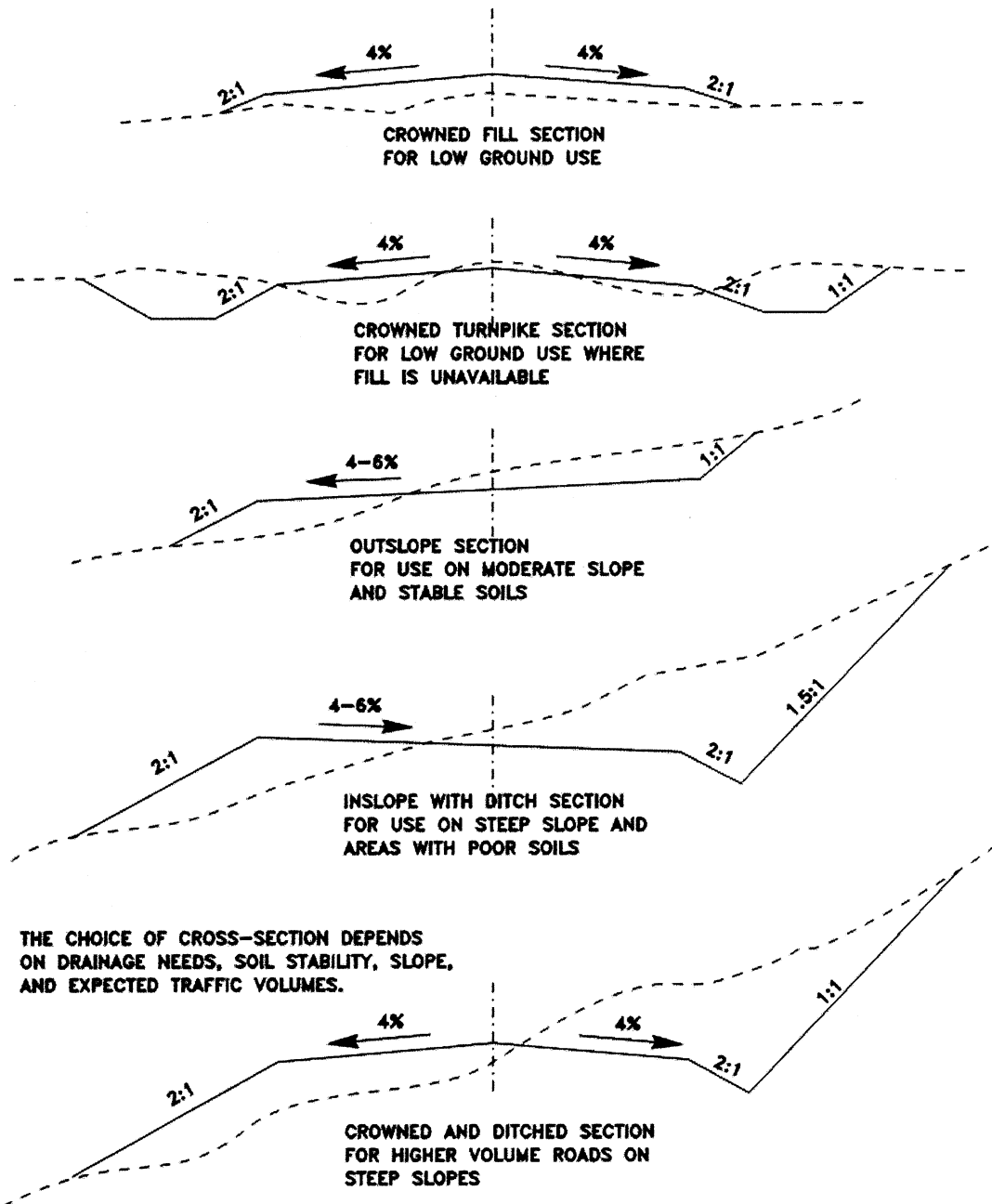
### ***Maintenance***

Initially inspect the road after each rainfall of 0.5 inch or more. Initially it would be better to inspect during the first few rainstorms. Look for water running down the road and for scour in the ditch lines. Look for water coming out of cut slopes and for upslope concentrated flows not going to culverts. If water bars or broad based dips are used see if they are deep enough to capture road surface runoff. If runoff goes past either practice, repair immediately.

If ruts are found immediately regrade and direct runoff into ditch line or to outslope as necessary.

FIGURE 3.35.1

# TYPES OF ROAD CROSS-SECTIONS



FROM: US FOREST SERVICE AND MICHIGAN DNR



FIGURE 3.35.2

# SEDIMENT AND EROSION CONTROL FOR ACCESS ROADS AND DRIVEWAYS

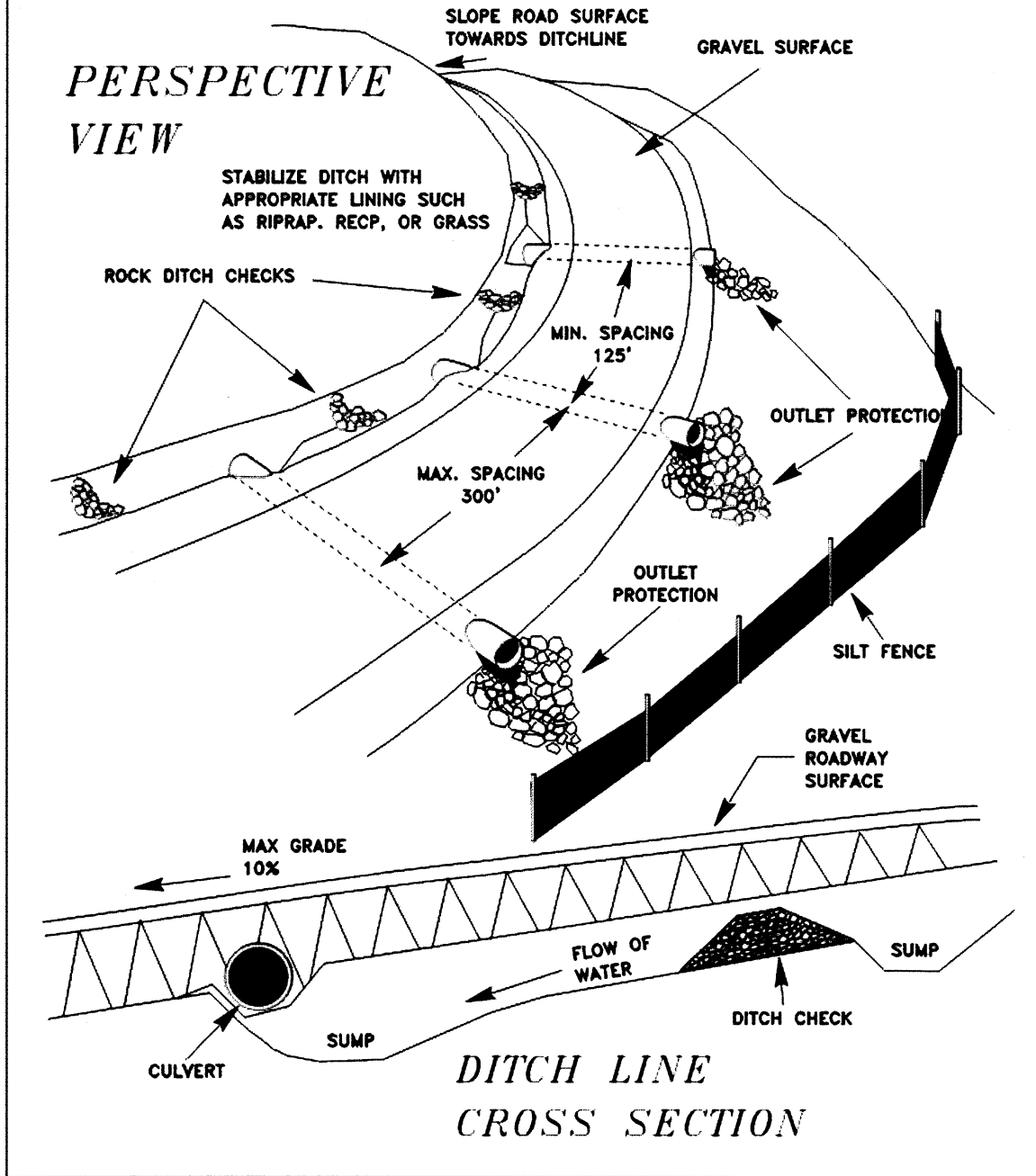
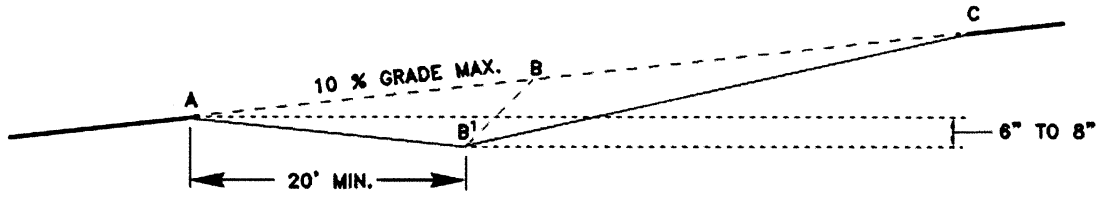
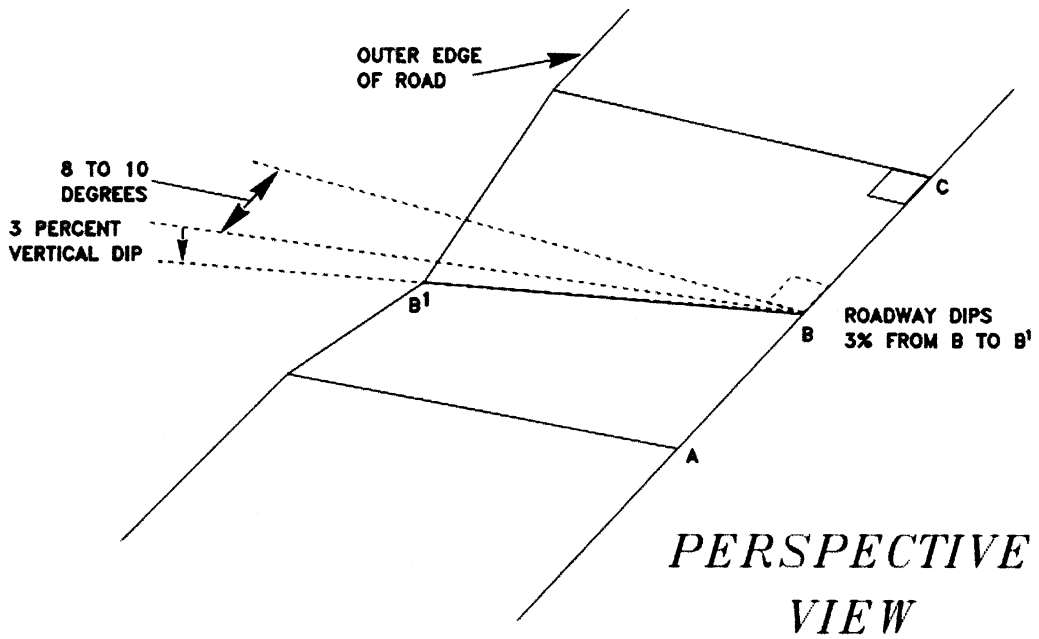


FIGURE 3.35.3

# BROAD-BASE DIP



## CROSS-SECTION

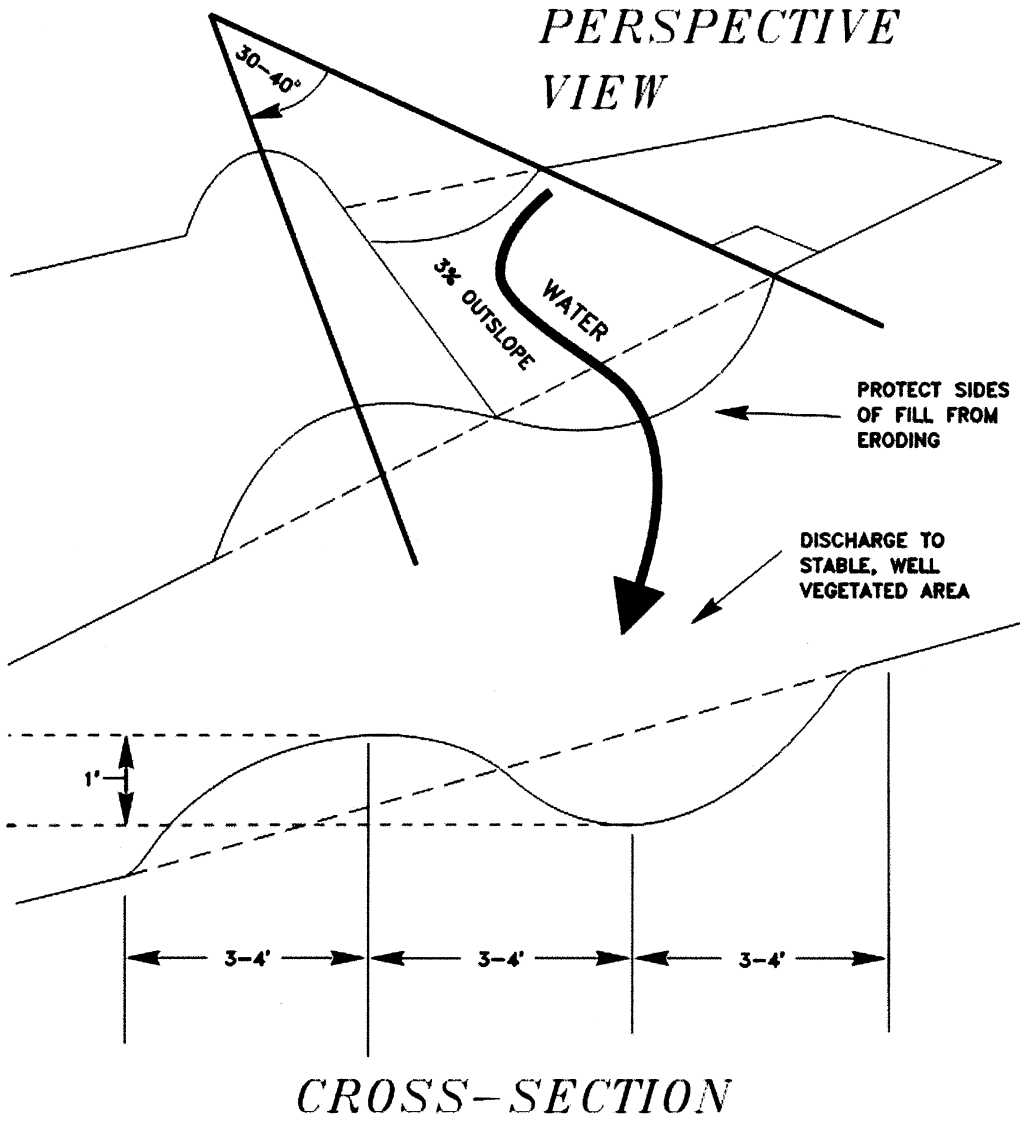


## PERSPECTIVE VIEW

$$\text{SPACING} = 400/\% \text{ GRADE} + 75'$$

FIGURE 3.3.4

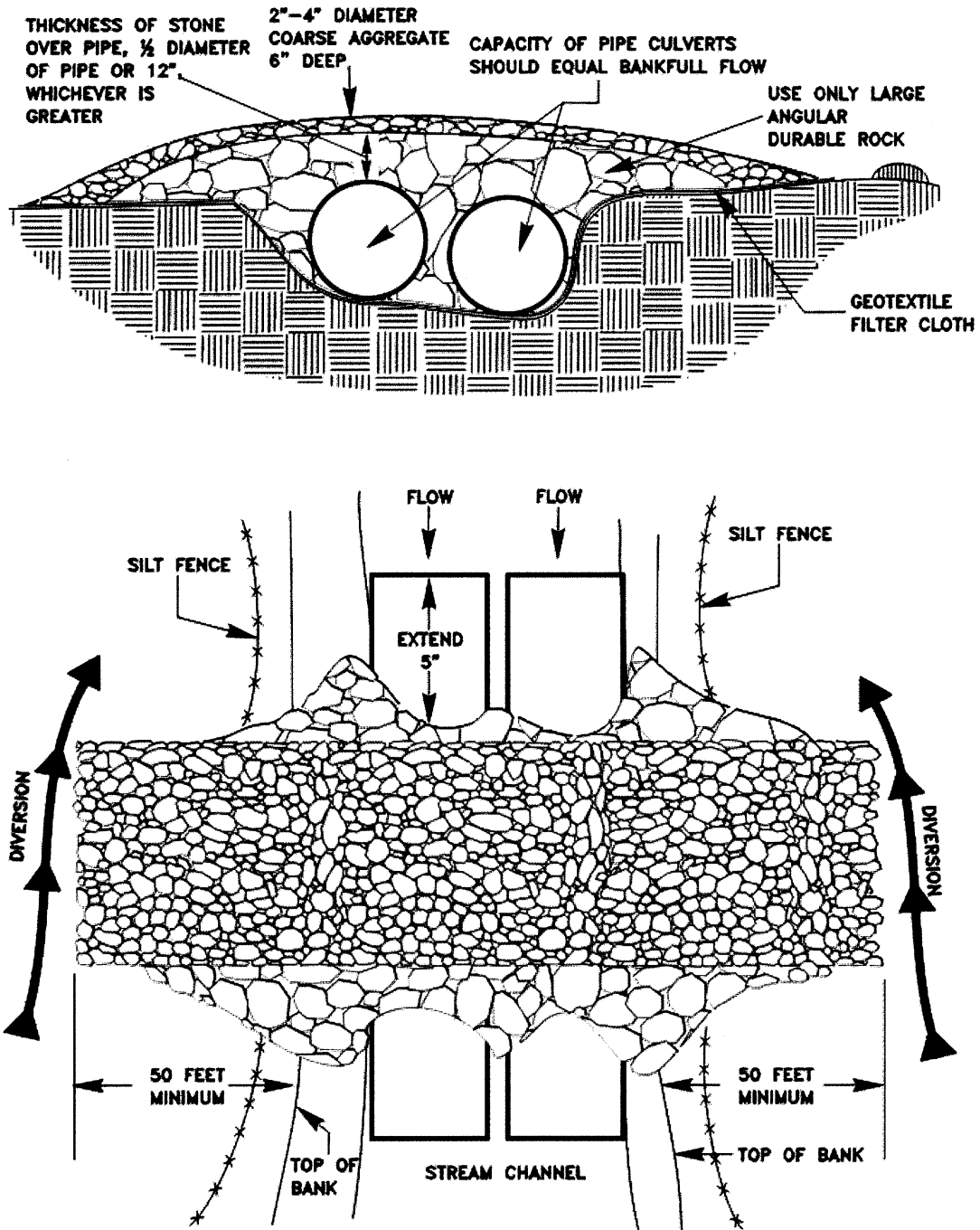
# WATER BAR



INCREASE THE DISTANCE BETWEEN  
THE BOTTOM OF THE DIP AND TOP  
OF THE BERM FOR IMPROVE DRIVEABILITY

FIGURE 3.35.5

# CULVERT STREAM CROSSING



FROM: VA DSWC

# CHAPTER 4

## HYDROLOGY

URBAN HYDROLOGY FOR SMALL WATERSHEDS (TR-55)

# URBAN HYDROLOGY FOR SMALL WATERSHEDS – TR-55

---

The following information was developed by the United States Department of Agriculture, Natural Resources Conservation Service, Conservation Engineering Division in Urban Hydrology for Small Watersheds TR-55, Technical Release 55 June 1986.

## Preface

Technical Release 55 (TR-55) presents simplified procedures to calculate storm runoff volume, peak rate of discharge, hydrographs, and storage volumes required for floodwater reservoirs. These procedures are applicable in small watersheds, especially urbanizing watersheds, in the United States. First issued by the Soil Conservation Service (SCS) in January 1975, TR-55 incorporates current SCS procedures. This revision includes results of recent research and other changes based on experience with use of the original edition.

The major revisions and additions are:

- A flow chart for selecting the appropriate procedure;
- Three additional rain distributions;
- Expansion of the chapter on runoff curve numbers;
- A procedure for calculating travel times of sheet flow;
- Deletion of a chapter on peak discharges;
- Modifications to the Graphical Peak Discharge method and Tabular Hydrograph method;
- A new storage routing procedure;
- Features of the TR-55 computer program; and
- Worksheets.

This revision was prepared by Roger Cronshey, hydraulic engineer, Hydrology Unit, SCS, Washington, DC; Dr. Richard H. McCuen, professor of Civil Engineering, University of Maryland, College Park, MD; Norman Miller, head, Hydrology Unit, SCS, Washington, DC; Dr. Walter Rawls, hydrologist, Agricultural Research Service, Beltsville, MD; Sam Robbins (deceased), formerly hydraulic engineer, SCS, South National Technical Center (NTC), Fort Worth, TX; and Don Woodward, hydraulic engineer, SCS, Northeast NTC, Chester, PA. Valuable contributions were made by John Chenoweth, Stan Hamilton, William Merkel, Robert Rallison (ret.), Harvey Richardson, Wendell Styner, other SCS hydraulic engineers, and Teresa Seeman.

Revised June 1986

Update of Appendix A January 1999

**A copy of the TR-55 Manual can be obtained at:**

[www.wcc.nrcs.usda.gov/hydro/hydro-tools-models-tr55.html](http://www.wcc.nrcs.usda.gov/hydro/hydro-tools-models-tr55.html)

# CHAPTER 5

DESIGN EXAMPLES

## Sediment Basin Design Example

Problem statement: Design a sediment basin that captures a drainage area of 25 acres during construction. The disturbed project area equals the drainage area to the basin.

When locating your basin, try to capture as much of the disturbed area from the construction site as necessary, while diverting as much undisturbed runoff coming to the site as possible.

Calculate the resultant total area draining to basin = 25 acres.

Calculate the total disturbed area draining to basin = 25 acres.

Required wet storage = 25 ac. x 1800 cf/ac = 45,000 cf

Required dry storage = 25 ac. x 1800 cf/ac = 45,000 cf

The clean-out volume corresponds to the volume equal to half the wet storage volume.

Clean-out volume = 25 x 900 cf/ac = 22,500 cf.

**Stage-Storage Chart** (determined from the basin/pond geometry, which is not given for this example). Assumes the following:

<b>Elevation</b> (ft.)	<b>Sum Volume</b> (ac-ft.)
151	0.00
152	0.15
153	0.33
154	0.55
155	0.81
156	1.10
157	1.44
158	1.82
159	2.25
160	2.73
161	3.26
162	3.84
163	4.48
164	5.18
165	5.93
166	6.75

With a pond bottom of elevation 151, the corresponding elevation for the wet storage volume = 45,000 cf (1.033 ac-ft) is approximately 155.8 feet.

The clean-out elevation is the elevation corresponding to the clean-out volume = 22,500 cf (0.52 ac-ft), which is equal to approximately 153.9 feet. Show this elevation on the plans and provide a means of determining it in the field.

With the wet storage volume elevation set at 155.8, the corresponding elevation for the dry storage volume (cumulative 90,000 cf or 2.066 ac-ft) is approximately 158.6 feet.



Set the top of the temporary riser above this elevation so top of riser = 159.0.

A perforated riser with a hole or series of holes should be provided at the wet storage elevation. In order to dewater the sediment basin in 48 to 72 hours, perforations should be sized in the riser according to the following equation:

$$A_o = A_s \times (2h)^{0.5} / (T \times C_d \times 20,428)$$

Where

$A_o$  = total area of dewatering holes, ft<sup>2</sup>

$A_s$  – surface area of the basin, sq.ft.

$H$  = head of water above the hole, ft

$C_d$  = coefficient of contraction for an orifice, ~ 0.6

$T$  = detention time needed to dewater the basin, hours

Using the basin geometry gives:

$$A_o = 21,000 \text{ sq.ft.} \times (2 \times 3.2 \text{ ft.})^{0.5} / (72 \times 0.6 \times 20428)$$

$A_o = 0.06 \text{ sq.ft.}$  which equals an orifice area with a diameter of 3.3 inches.

Use 3 – 1-inch holes

Compute the peak discharge from a 2-year and 25-year, 24-hour storm event.

Condition	Area	CN	Tc
	Acre		Hrs
Pre-developed	25	73	0.499
Post-developed	25	78	0.267

From TR-55 Worksheets 2 and 3

### Perform Preliminary Hydrologic Calculations

The site is located in a county in West Virginia that has the following 24-hour rainfalls:

2-year, 24-hour rainfall = 2.75 inches

25-year, 24-hour rainfall = 4.78 inches

Condition	Q 2-yr	Q2-yr	Q 25-yr	Q 25-yr
Runoff	inches	cfs	inches	cfs
Post-developed	0.962	24.4	2.530	69.2

From TR-55 Worksheet 4 or 5b

Determine the maximum principal spillway capacity for a Q2 of 24.4 cfs

- Try a riser with a diameter of 36-inches and a barrel with a diameter of 24 inches, trying to keep the diameter of the riser = 1.5 x the diameter of the barrel to improve the efficiency of the principle spillway system.
- Solving the weir equation for the riser with a perimeter,  $L = 9.4248$  feet and an area,  $A = 7.06858$ , gives an  $H = 0.88$  feet. So the 2-year storm will pass through the temporary riser with an  $H$  of 0.88 feet.
- Check the pipe barrel performance for the 2-year event with an assumed size of 24-inches, a pipe length of 100 feet, a pipe slope of 10%, and a roughness coefficient of  $n=0.024$ .
- Solving the pipe equation for inlet control gives  $Q = 45.4$  cfs (refer to Sediment Basin Outlet results).
- Solving the pipe equation for outlet control gives  $Q = 44.0$  cfs (refer to Sediment Basin Outlet results).
- 

For the 25-year design storm:

Condition	Q 25-yr	Q 25-yr
Runoff	inches	cfs
Post-developed	2.530	69.2

From TR-55 Worksheet 4 or 5b

- Knowing the Runoff  $Q$  (inches) from TR-55 Worksheet 2 and the Area ( in square miles), compute the Runoff Volume  $V_r = Q (A) 53.33$   
 $= 2.53 \times 0.03906 \times 53.33 = 5.27$  ac. ft.

**Stage-Storage Chart** Using the stage-storage chart for a runoff volume of 5.27 ac-ft.-

<b>Elevation</b>	<b>Sum Volume</b>
(ft.)	(ac-ft.)
151	0.00
152	0.15
153	0.33
154	0.55
155	0.81
156	1.10
157	1.44
158	1.82
159	2.25
160	2.73
161	3.26
162	3.84
163	4.48
164	5.18
165	5.93
166	6.75

With a pond bottom of elevation 151, the corresponding elevation for the 25-year runoff volume = 5.27 ac-ft is approximately 164.1 feet. Set the emergency spillway at an elevation at least 1 foot minimum above the top of the temporary riser elevation of 159.0 feet, , while ensuring a minimum freeboard of 1' above the top of the basin elevation which is 164 feet. Try setting the emergency spillway at 161.00.

Use the Design Data for Earth Spillways (USDA-SCS) to determine the spillway width for the associated head. A width of 28 feet using the earth spillway design data allows for the passage of 56 cfs with 1 foot of head, and 179 cfs with 2 foot of head, assuming a z of 2 and an n value of 0.040. (See the Sediment Basin Outlet results).

Follow the recommendations for providing a core trench if necessary, anti-seep collars as needed, provide an allowance for settlement of the embankment, and provide baffles as needed.

## Sediment Basin Outlet Results

Elevation (ft)	Orifice Outlet						36" Riser Outlet								24" Barrel Pipe				Emergency Spillway		Overtopping the Dam		Total Discharge	Storage
	H1 (ft)	Q (cfs)	H (ft)	Q (cfs)	H (ft)	Q (cfs)	Orifice		Weir		Orifice		Weir		Inlet		Outlet		H6 (ft)	Q (cfs)	H (ft)	Q (cfs)	Q (cfs)	Ac-ft.
151	0	0	0	0	0	0	0	0	0	0	0	0	0	0					0	0	0	0	0.0	0.00
152	1	0	0	0	0	0	0	0	0	0	0	0	0	0					0	0	0	0	0.0	0.15
153	2	0	0	0	0	0	0	0	0	0	0	0	0	0					0	0	0	0	0.0	0.33
154	3	0	0	0	0	0	0	0	0	0	0	0	0	0					0	0	0	0	0.0	0.55
155	4	0	0	0	0	0	0	0	0	0	0	0	0	0					0	0	0	0	0.0	0.81
156	5	0	0	0	0	0	0	0	0	0	0	0	0	0					0	0	0	0	0.0	1.10
157	6	0	0	0	0	0	0	0	0	0	0	0	0	0					0	0	0	0	0.0	1.44
158	7	0	0	0	0	0	0	0	0	0	0	0	0	0					0	0	0	0	0.0	1.82
159	8	0	0	0	0	0	0	0	0	0	0	0	0	0					0	0	0	0	0.0	2.25
160	9	0	0	0	0	0	1	34.0	1	29.2	0	0	0	0	9	45.4	19	44.0	0	0	0	0	29.2	2.73
161	10	0	0	0	0	0	2	48.1	2	82.6	0	0	0	0	10	47.8	20	45.2	0	0	0	0	45.2	3.26
162	11	0	0	0	0	0	3	59.0	3	151.8	0	0	0	0	11	50.2	21	46.3	1	56	0	0	102.3	3.84
163	12	0	0	0	0	0	4	68.1	4	233.7	0	0	0	0	12	52.4	22	47.4	2	179	0	0	226.4	4.48
164	13	0	0	0	0	0	5	76.1	5	326.7	0	0	0	0	13	54.5	23	48.4	3	361	0	0	409.4	5.18

Orifice Equation  
 Inv. =  
 centerline =  
 C =  
 A =  
 $Q = CA((2gH)^{1/2})$

Riser Orifice Equation  
 Inv. = 159  
 C = 0.6  
 A = 7.0686  
 $Q = CA((2gH)^{1/2})$

Riser Weir Equation  
 Inv. = 159  
 C = 3.1  
 L = 9.4248  
 $Q = CL(H^{3/2})$

Barrel Inlet Control  
 Inv. = 150  
 centerline = 151  
 C = 0.6  
 A = 3.1416  
 $Q = CA((2gH)^{1/2})$

Barrel Outlet Control  
 Inv. Out = 140  
 Centerline = 141  
 L = 100  
 km = 0.024  
 kp = 0.0246  
 A = 3.1416  
 $Q = A(((2gH)/(1+km+kpL))^{1/2})$

Emergency Spillway taken from USDA-SCS  
 Earth Spillway Data  
 Width = 28', z=2, n=0.040

## Stormwater Management Pond Design Example

Problem statement: Design a stormwater management extended detention pond that will provide control of the channel protection volume (1-yr) event with a 24-hour extended detention time, the overbank protection volume (10-year) event, and also safely pass the 100-year event.

### Step 1 – Compute runoff control volumes from the SCS approach.

Be sure to check to see if there is a Water Quality Volume (WQv) requirement, and compute as required (for example, there is a WQv requirement in Berkeley County). The following example assumes there is no water quality volume requirement.

**Develop Site Hydrologic and Hydrologic Input Parameters.** Any hydrologic models using SCS procedures, such as TR-20, HEC-HMS, or HEC-1, can be used to perform preliminary hydrologic calculations. Chapter 4 of the manual contains TR-55 Urban Hydrology for Small Watersheds that gives instructions and examples in determining the Runoff Coefficient, and Time of Concentration. TR-55 methodology is used in this design example.

Condition	Area	CN	Tc
	Acre		Hrs
Pre-developed	38	73	0.499
Post-developed	38	78	0.267

From TR-55 Worksheets 2 and 3

### Perform Preliminary Hydrologic Calculations

The site is located in a county in West Virginia that has the following 24-hour rainfalls:

1-year, 24-hour rainfall = 2.35 inches  
 10-year, 24-hour rainfall = 4.20 inches  
 100-year, 24-hour rainfall = 5.75 inches

Condition	Q 1-yr	Q1-yr	Q 10-yr	Q 100-yr
Runoff	inches	cfs	cfs	cfs
Pre-developed	0.49	29.2	115.3	210.7
Post-developed	0.69	62.8	197.2	335.3

From TR-55 Worksheet 4 or 5b

### Compute Channel Protection Volume, (Cpv)

For stream channel protection, provide 24 hours of extended detention for the 1-year event.

Utilize SCS approach to compute channel protection storage volume

- Initial abstraction ( $I_a$ ) for CN of 78 is 0.564 [ $I_a = (200/CN)-2$ ]
- $I_a/P = (0.564)/2.35$  inches = 0.24
- $T_c = 0.267$  hours
- $q_u = 645$  csm/in (Type II storm)

Knowing  $q_o$ ,  $q_i$ ,  $q_u$  and  $T$  (extended detention time), find  $q_o/q_i$  for the 1-year design event. For a Type II rainfall distribution, and using TR-55 Worksheet 6a:

- Peak outflow discharge/peak inflow discharge ( $q_o/q_i$ ) =  $29.2/62.8 = 0.465$
- Using  $q_o/q_i$  and TR-55 Figure 6-1, find  $V_s/V_r$ , where  $V_s$  equals channel protection storage ( $C_{pv}$ ) and  $V_r$  equals the volume of runoff in inches.
- $V_s/V_r = 0.295$
- Knowing the Runoff  $Q$  (inches) from TR-55 Worksheet 2 and the Area (in square miles), compute the Runoff Volume  $V_r = Q (A) 53.33$   
=  $0.692 \times 0.1406 \times 53.33 = 5.19$  ac. ft.
- Storage Volume  $V_s = V_r (V_s/V_r) = 5.19 \times 0.295 = 1.53$  ac.ft or 66,647 cf.

### **Compute Overbank Flood Protection Volume, (Q10-yr)**

Knowing  $q_o$ ,  $q_i$ ,  $q_u$  and  $T$  (extended detention time), find  $q_o/q_i$  for the 10-year design event. For a Type II rainfall distribution, and using TR-55 Worksheet 6a:

- Peak outflow discharge/peak inflow discharge ( $q_o/q_i$ ) =  $115.3/197.2 = 0.585$
- Using  $q_o/q_i$  and TR-55 Figure 6-1, find  $V_s/V_r$ , where  $V_s$  equals overbank flood protection volume storage and  $V_r$  equals the volume of runoff in inches.
- $V_s/V_r = 0.250$
- Knowing the Runoff  $Q$  (inches) from TR-55 Worksheet 2 and the Area ( in square miles), compute the Runoff Volume  $V_r = Q (A) 53.33$   
=  $2.048 \times 0.1406 \times 53.33 = 15.36$  ac. ft.
- Storage Volume  $V_s = V_r (V_s/V_r) = 15.36 \times 0.250 = 3.84$  ac.ft or 167,270 cf.

### **Analyze Safe Passage of the 100-Year Design Storm (Q100)**

Check to see if there are any local requirements or field observations that would advocate controlling the 100-year storm. If so, storage estimates would have been made similar to the volumes in the previous steps.

**Step 2 – Determine pond location and preliminary geometry.** Keep in mind the recommendations of keeping the length to width ratio greater than 2:1, making the distance between the inflows and outflow of the pond as maximum as possible, and providing sediment forebays, safety ledges and other features recommended in the local jurisdiction.

### Step 3 – Set water surface elevation for Channel Protection Event.

Use TR-55 Worksheet 6A to develop a stage/storage chart for the pond based on the preliminary geometry.

**Stage-Storage Chart** (determined from the basin/pond geometry, which is not given for this example) Assumes the following:

<b>Elevation</b> (ft.)	<b>Sum Volume</b> (ac-ft.)
151	0.00
152	0.15
153	0.33
154	0.55
155	0.81
156	1.10
157	1.44
158	1.82
159	2.25
160	2.73
161	3.26
162	3.84
163	4.48
164	5.18
165	5.93
166	6.75

Determine the maximum storage elevation corresponding to the storage volume computed in Step 1 for the 1-year channel protection event. From the stage-storage chart, the corresponding water surface elevation for the 1-year channel protection design event = 157.3.

Next, determine the size of a low-flow orifice by defining the average release rate to empty 1.53 ac-ft in 24 hours.

$$Q = (1.53 \text{ ac-ft} \times 43,560 \text{ ft}^2/\text{ac}) / (24 \text{ hrs} \times 3600 \text{ sec/hr}) = 0.771 \text{ cfs}$$

With the pond bottom set at elevation 151.0 feet, that gives an average head of 3.15 ft, as the pond empties from 157.3 feet to 151.00 feet. Solve the orifice flow equation:

$$Q = C A ((2 g h) ^ {1/2})$$

where

Q = discharge, cfs

C = discharge coefficient, 0.62

A = cross sectional area of the orifice, ft<sup>2</sup>

h = total head, using an average head of 3.15 ft to empty the volume.

Solving for the area, A, gives an orifice diameter of approximately 4 inches.

#### **Step 4 – Set water surface elevation for Overbank Protection Volume.**

From the stage/storage chart, determine the maximum storage elevation corresponding to the 10-year design event storage volume.

From the stage-storage chart, the corresponding water surface elevation for the 10-year design event = 162.0 feet.

Set the elevation of the riser above the 1-year water surface elevation but below the 10-year water surface elevation and then calculate the size of the riser by solving the weir and orifice equations.

- Set the crest elevation at 160.0 feet, which gives a head of 2.0 feet. At this elevation, the low flow orifice head is 10.833', measured to the centerline of the orifice. Solving the orifice equation, the low flow orifice  $Q = 1.4$  cfs.
- The maximum outflow  $Q = 115.3 - 1.4$  cfs = 113.9 cfs (Pre-developed 10-year flow minus the orifice flow)
- Solving the weir equation for the riser gives an  $L = 13.01$  feet. In order to make sure that the barrel pipe controls the flow before the riser is submerged, choose a riser with a slightly larger  $L$ . Therefore, select a 60-inch riser with a perimeter,  $L = 15.7$  ft and an area,  $A = 19.63$  square feet.
- Design the pipe barrel based on the 10-year storm event.
- Corresponding 10-year water surface elevation from above = 162.0 feet.
- Invert elevation = 150.0 feet.
- Head = 12.0 feet
- Determine the slope of the outlet pipe; Slope = 10%.
- Maximum  $Q = 115.3$  cfs
- Assuming CMP, with a Manning's roughness  $n = 0.024$ , determine the diameter barrel to pass 115.3 cfs.
- Try a diameter  $D = 36$ -inches.
- Solving the pipe equation for inlet control gives  $Q = 110.3$  cfs (refer to Detention Basin Outlet results).
- Solving the pipe equation for outlet control gives  $Q = 121.6$  cfs (refer to Detention Basin Outlet results).

Next, develop and complete the stage-discharge storage summary (see the Detention Basin Outlet result) up to the preliminary 10-year water surface elevation = 162.0 feet and route the 10-year post-developed condition inflow by hand or using computer software.

#### **Step 5 - Design the emergency spillway based on safely passing the 100-year storm event with a minimum of 1 foot of freeboard.**

Set the emergency spillway elevation above the 10-year water surface elevation, but at least a minimum of 2' below the top of the embankment. Setting the crest elevation at elevation 16 feet gives a head of 1.0 feet.

The maximum  $Q_{100}$  inflow = 210.7 cfs – 125 cfs (barrel outflow) = 85.7 cfs.



Use the Design Data for Earth Spillways (USDA-SCS) to determine the spillway width for the associated head. A width of 28 feet using the earth spillway design data allows for the passage of 56 cfs with 1 foot of head, and 179 cfs with 2 foot of head, assuming a z of 2 and an n value of 0.040. (See the Detention Basin Outlet results).

There are several excellent examples in various stormwater management manuals available on the internet for designing a stormwater management pond as well as other best management practices. This example only illustrates the preliminary, basic design for a stormwater management pond.

## Detention Basin Outlet Results

Elevation (ft)	4" Orifice Outlet						60" Riser Outlet								36" Barrel Pipe				Emergency Spillway		Overtopping the Dam		Total Discharge	Storage Ac-ft.
							Orifice		Weir		Orifice		Weir		Inlet		Outlet		H (ft)	Q (cfs)	H (ft)	Q (cfs)	Q (cfs)	
	H (ft)	Q (cfs)	H (ft)	Q (cfs)	H (ft)	Q (cfs)	H (ft)	Q (cfs)	H (ft)	Q (cfs)	H (ft)	Q (cfs)	H (ft)	Q (cfs)	H (ft)	Q (cfs)	H (ft)	Q (cfs)						
151	0	0	0	0	0	0	0	0	0	0	0	0	0	0					0	0	0	0	0.00	0.00
152	0.8333	0.38	0	0	0	0	0	0	0	0	0	0	0	0					0	0	0	0	0.38	0.15
153	1.8333	0.57	0	0	0	0	0	0	0	0	0	0	0	0					0	0	0	0	0.57	0.33
154	2.8333	0.71	0	0	0	0	0	0	0	0	0	0	0	0					0	0	0	0	0.71	0.55
155	3.8333	0.82	0	0	0	0	0	0	0	0	0	0	0	0					0	0	0	0	0.82	0.81
156	4.8333	0.92	0	0	0	0	0	0	0	0	0	0	0	0					0	0	0	0	0.92	1.10
157	5.8333	1.01	0	0	0	0	0	0	0	0	0	0	0	0					0	0	0	0	1.01	1.44
158	6.8333	1.10	0	0	0	0	0	0	0	0	0	0	0	0					0	0	0	0	1.10	1.82
159	7.8333	1.18	0	0	0	0	0	0	0	0	0	0	0	0					0	0	0	0	1.18	2.25
160	8.8333	1.25	0	0	0	0	0	0	0	0	0	0	0	0					0	0	0	0	1.25	2.73
161	9.8333	1.32	0	0	0	0	1	94.52	1	48.7	0	0	0	0	9.5	104.9	19.5	118.5	0	0	0	0	50.0	3.26
162	10.833	1.38	0	0	0	0	2	133.67	2	137.7	0	0	0	0	10.5	110.3	20.5	121.5	0	0	0	0	110.3	3.84
163	11.833	1.45	0	0	0	0	3	163.71	3	252.9	0	0	0	0	11.5	115.4	21.5	124.5	0	0	0	0	115.4	4.48
164	12.833	1.51	0	0	0	0	4	189.04	4	389.4	0	0	0	0	12.5	120.3	22.5	127.3	1	56	0	0	176.3	5.18
165	13.833	1.56	0	0	0	0	5	211.35	5	544.1	0	0	0	0	13.5	125.1	23.5	130.1	2	179	0	0	304.1	5.93
166	14.833	1.62	0	0	0	0	6	231.52	6	715.3	0	0	0	0	14.5	129.6	24.5	132.9	3	361	0	0	490.6	6.75

Orifice Equation  
 Inv. = 151  
 centerline = 151.17  
 C= 0.6  
 A= 0.087 sf  
 $Q=CA((2gH)^{1/2})$

Riser Orifice Equation  
 Inv. = 160  
 C= 0.6  
 A= 19.635  
 $Q=CA((2gH)^{1/2})$

Riser Weir Equation  
 Inv.= 160  
 C= 3.1  
 L= 6.283  
 $Q=CL(H^{3/2})$

Barrel Inlet Control  
 Inv. = 150  
 centerline = 151.5  
 C= 0.6  
 A= 7.0686  
 $Q=CA((2gH)^{1/2})$

Barrel Outlet Control  
 Inv. Out= 140  
 Centerline= 141.5  
 L= 100  
 km= 0.024  
 kp= 0.0246  
 A= 7.0686  
 $Q=A(((2gH)/(1+km+kpL))^{1/2})$

Emergency Spillway taken from USDA-SCS  
 Earth Spillway Data  
 Width = 28', z=2, n=0.040

# CHAPTER 6

SAMPLE PLAN –  
INDIVIDUAL HOUSE SITE

SAMPLE PLAN –  
SMALL COMMERCIAL DEVELOPMENT SITE

SAMPLE PLAN –  
UTILITY LINE CROSSING

## 6.0 – Individual House Sample Sediment and Erosion Control Plan

### **Primary Concerns Related to Erosion and Sedimentation**

#### **Water Quality**

Sediment is the number one pollutant, by volume, of surface waters in the state of West Virginia. It impacts water quality by degrading the habitat of aquatic organisms and fish, by decreasing recreational value, and by promoting the growth of nuisance weeds and algae.

#### **Flooding**

Sediment accumulation in streams, lakes, and rivers reduces their capacity to contain stormwater, which can result in increased flooding.

#### **Local Taxes**

Sediment that finds its way into streets, storm sewers, and ditches results in additional maintenance costs for local, state, and federal governments.

#### **Property Values**

Sediment deposits not only impair water quality but also damage property, thus reducing its use and value.

### **Sample Erosion and Sediment Control Plan**

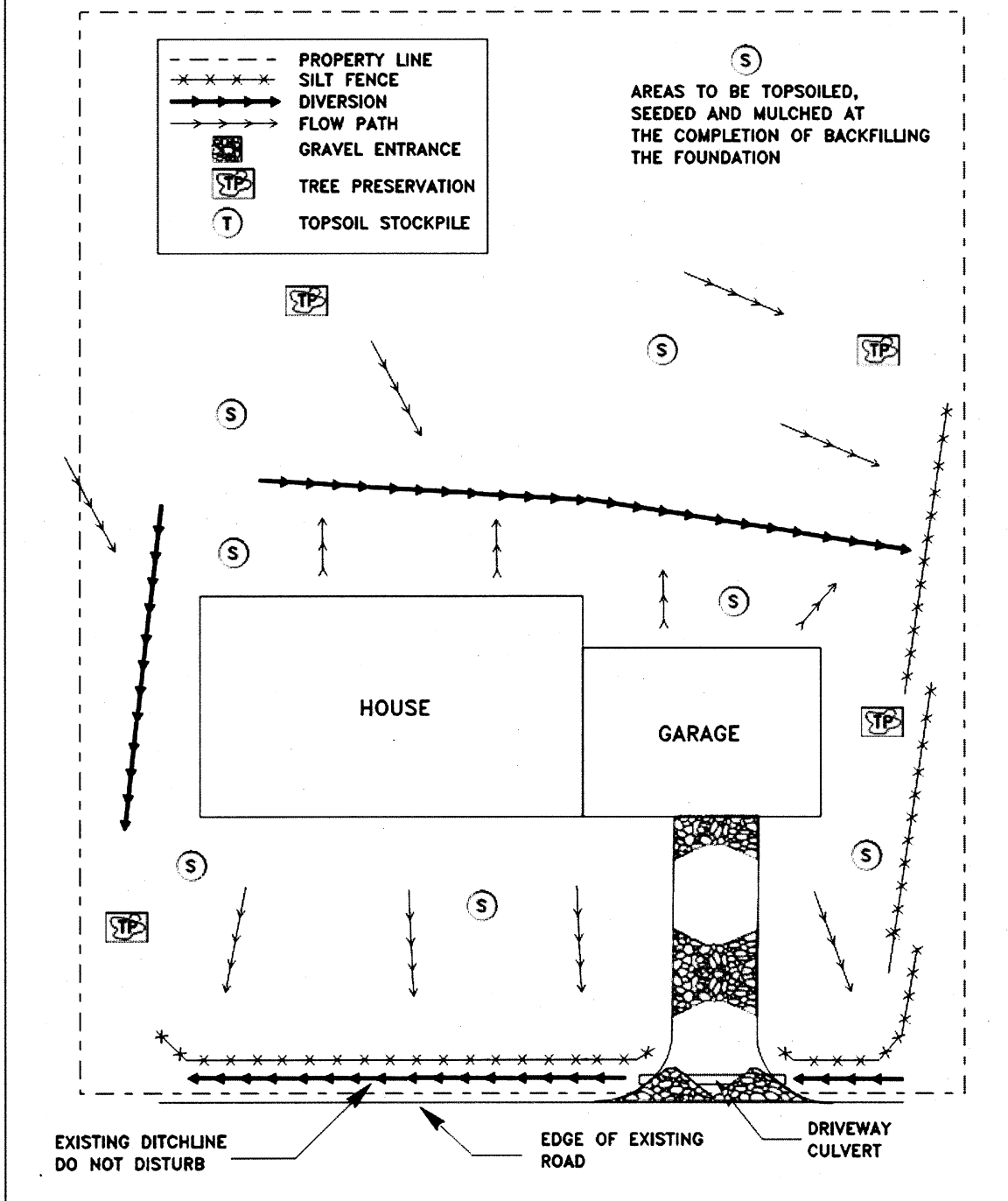
Every building site is unique and poses its own potential erosion hazards. In many instances, additional or alternative control methods are necessary if the lot is adjacent to a creek, lake, or wetland; slopes are greater than six percent; receives runoff from adjacent areas; and/or more than one acre of ground is disturbed.

#### **NOTES:**

1. It is the responsibility of the property owner and contractor to comply with State laws and local and county ordinances regarding construction site erosion and sediment control.
2. This plan is only a sample plan and is not intended to be all-inclusive or address every situation; additional or modified practices may be required on some sites.
3. Erosion or sediment control measures must be functional and maintained throughout construction.
4. Maintain positive drainage away from the structure(s).

FIGURE 6.1

# INDIVIDUAL HOUSE LOT SEDIMENT CONTROL PLAN



## **Controlling Building Site Erosion & Sedimentation**

Erosion control is important on any building site regardless of its size. Usually, principles and methods for controlling erosion and reducing offsite sedimentation are relatively simple and inexpensive. Here are four basic steps to follow when developing a building site.

### **Evaluate the Site**

Inventory and evaluate the resources on the lot before building. Location of structures should be based on the lot's natural features. Identify trees that you want to save and vegetation that will remain during construction. Also identify areas where you want to limit construction traffic. Wherever possible, preserve existing vegetation to help control erosion and off-site sedimentation.

### **Select & Install Initial Erosion/ Sediment Control Practices**

Determine the specific practices needed, and install them before clearing the site. Among the more commonly used practices are vegetative filter strips, silt fences, gravel drives, and inlet protection.

### **Develop a Maintenance Program**

Maintenance of all practices is essential for them to function properly. Practices should be inspected twice a week and after each rainfall event. When a problem is identified, repair or replace the practice immediately. If frequent repairs are required (such as Silt Fence being knocked down), another more substantial practice may need to be selected. In addition, any sediment that is tracked onto the street should be scraped and deposited in a protected area. Do not flush sediment from the street with water.

### **Revegetate the Site**

Providing a vegetative cover is the most important practice in preventing erosion and sediment. Therefore, establish vegetation as soon as possible. A well-maintained lot has a higher sale potential.

### **Building Lot Drainage**

The best time to provide for adequate lot drainage is before construction begins. With proper planning, most drainage problems can be avoided. That's important because correcting a problem after it occurs is usually much more difficult and costly. Here's what it takes to ensure good lot surface and subsurface drainage.

#### **Surface Drainage**

- Position the structure a minimum of 18 inches above street level.

- Divert stormwater runoff away from the foundation by grading the lawn to provide at least six inches of vertical fall in the first ten feet of horizontal distance.
- Construct side and rear yard swales to take surface water away from the structure.
- Do not fill in existing drainage channels and roadside ditches, since that could result in wetness problems on someone else's property and/or damage to adjacent road surfaces.

### **Subsurface Drainage**

- Provide an outlet for foundation or footer drains and for general lot drainage by using storm sewers (where allowed), or obtain drainage easements if you must cross adjoining properties.

## **Construction Sequence for Erosion & Sediment Control Practices**

### **1. Evaluate the Site**

Before construction, evaluate the site; mark vegetative areas and trees to be protected, unique areas to preserve, on-site septic system absorption fields, and vegetation suitable for filter strips, especially in perimeter areas.

#### **Identify Vegetation to be Saved**

Select and identify the trees, shrubs and other vegetation to be saved (see Step 2: "Vegetative Filter Strips").

#### **Protect Trees & Sensitive Areas**

- To prevent root damage, do not grade, burn, stock pile topsoil, or park vehicles near trees or in areas marked for preservation.
- Place plastic mesh or snow fence barriers around the trees' driplines to protect the area below their branches.
- Place a physical barrier, such as plastic fencing, around the area designated for a septic system absorption field (if applicable).

### **2. Install Perimeter Erosion and Sediment Controls**

Identify the areas where sediment-laden runoff could leave the construction site, and install perimeter controls to minimize the potential for off-site sedimentation. It's important that perimeter controls are in place before any earthmoving activities begin.

#### **Protect Down-Slope Areas with Vegetative Filter Strip**

- On slopes of less than six percent, preserve a 20-to 30-foot wide (minimum) vegetative buffer strip around the perimeter of the property, and use it as a filter strip for trapping sediment.
- Do not mow filter strip vegetation shorter than four inches.

## **Protect Down-Slope Areas with Silt Fence and Other Appropriate Practices**

- Use silt fencing along the perimeter of the lot's downslope side(s) to trap sediment. Refer to silt fence practices.

## **Install Stabilized Construction Entrance**

- Restrict all lot access to this drive to prevent vehicles from tracking mud onto roadways or destroying perimeter controls. Refer to Stabilized Construction Entrances.

### **3. Prepare the site for construction**

Prepare the site for construction and for installation of utilities. Make sure all contractors (especially the excavating contractor) are aware of areas to be protected.

## **Salvage and Stockpile Topsoil or Subsoil**

- Remove topsoil (typically the upper four to six inches of the soil material) and stockpile.
- Remove subsoil, including any excavated material associated with basement construction, and stockpile separately from the topsoil.
- On small building sites, it may not be feasible to stockpile soil material on each individual lot due to space limitations. In these situations, soil material should be transported to protected areas designated on the overall construction plan or those areas designated by the developer.
- Locate the stockpiles away from any downslope street, driveway, stream, lake, wetland, ditch or drainageway.
- Immediately after stockpiling, temporarily seed the stockpiles with annual rye or winter wheat and/or install sediment barriers around the perimeter of the piles.

### **4. Build Structure(s) and Install Utilities**

Construct the home and install the utilities; also install the sewage disposal system and drill water well (if applicable); then consider the following:

## **Install Downspout Extenders**

- Although not required, downspout extenders are highly recommended as a means of preventing lot erosion from roof runoff.
- Add the extenders as soon as the gutters and downspouts are installed.
- Be sure the extenders have a stable outlet, such as a paved area, or a well vegetated area. Do not route runoff directly to a street in winter due to the formation of ice.

Refer to temporary downspout extenders diagram.



## **5. Maintain Control Practices**

Maintain all erosion and sediment control practices until construction is completed and the lot is stabilized.

- Inspect the control practices daily and after each storm event, making any needed repairs immediately.
- Toward the end of the each workday, sweep or scrape up any soil tracked onto roadway(s). Do not flush mud down the street with water.

## **6. Revegetate Building Site**

Immediately after all outside construction activities are completed, stabilize the lot with sod, seed, and/ or mulch.

### **Redistribute the Stockpiled Subsoil and Topsoil**

- Spread the stockpiled subsoil to rough grade.
- Spread the stockpiled topsoil to a depth of four to six inches over rough-graded areas.
- Fertilize and lime according to soil test results or recommendations of a seed supplier or a professional landscaping contractor. Fertilize and lime if needed according to soil test (or apply 10 lb./1000 sq. ft. of 10-10-10 fertilizer).

### **Seed or Sod Bare Areas**

- Contact local seed suppliers or professional landscaping contractors for recommended seeding mixtures and rates.
- Follow recommendations of a professional landscaping contractor for installation of sod.
- Rake lightly to cover seed with ¼” of soil. Roll lightly.
- Water newly seeded or sodded areas every day or two to keep the soil moist. Less watering is needed once grass is two inches tall.

### **Mulch Newly Seeded Areas**

- Spread straw mulch on newly seeded areas, using one and one half to two bales of straw per 1,000 square feet. The mulch should cover to where the ground is just visible.
- On flat or gently sloping land, anchor the mulch by crimping it two to four inches into the soil. On steep slopes, anchor the mulch with netting or tackifiers. An alternative to anchored mulch would be the use of erosion control blankets.

## **Temporary Seeding**

If the site will not be permanently seeded anytime soon, sow 40 lbs of Annual Rye (year round) or 170 lbs. of Winter Wheat (fall and winter) per acre on all disturbed soils immediately upon backfilling the foundation.

### **7. Remove Remaining Temporary Control Measures**

Once the sod and/or vegetation is well established, remove any remaining temporary erosion and sediment control practices, such as:

- Remove downspout extenders. Or, shorten to outlet on an established vegetated area, allowing for maximum filtration.
- Remove storm sewer inlet protection measures.

## **Individual Erosion & Sediment Control Practices for Homebuilders**

### **Silt Fence**

1. Install silt fence parallel to the contour of the land.
2. Extend ends upslope to allow water to pond behind fence.
3. Excavate a trench 4-inches wide, 8-inches deep.
4. Install fence with posts on the down slope side.
5. Place 12-inches of fabric in the trench, extending the bottom four inches toward the upslope side.
6. Join silt fence sections by using a wrap joint.
7. Backfill trench with soil materials and compact.
8. Inspect at least weekly and after each storm event, repairing as needed and removing sediment deposits when they reach one-half the fence height.

**Note:** Silt fence has a life expectancy of six months to one year, whereas straw bale barriers have a limited life of three months or less.

### **Stabilized Construction Entrance**

1. Place six inches of 2" to 4" coarse aggregate over a stable subgrade.
2. Construct the drive at least 12-feet wide and 50-feet long or the distance to the foundation.
3. Add stone as needed to maintain six inches of clean depth.
4. To improve stability or if wet conditions are anticipated, place geotextile fabric on the graded foundation.

### **Temporary Downspout Extenders**

1. Install extenders as soon as gutters and downspouts are installed to prevent erosion from roof runoff.
2. Use non-perforated (un-slotted) drainage tile.

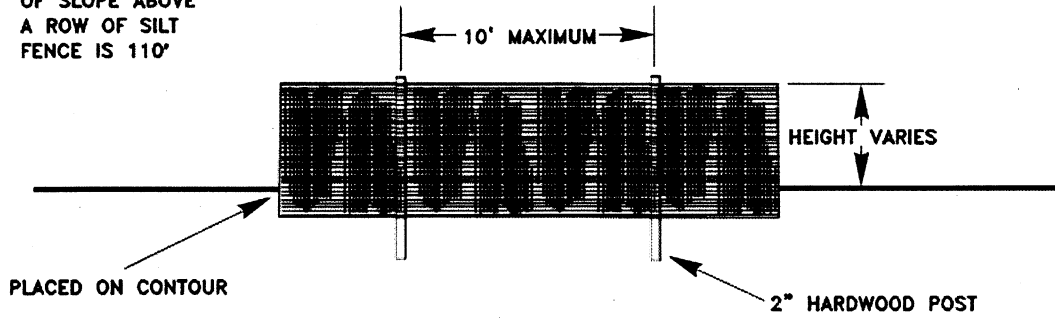
3. Route water to a stable grassed or paved area or to the storm sewer. Do not route water directly to a street or sidewalk in the winter due to the formation of ice.
4. Remove downspout extenders after vegetation is established.

For more detailed information of these and other practices, the West Virginia Erosion and Sediment Control Manual is available to assist you in making informed decisions.

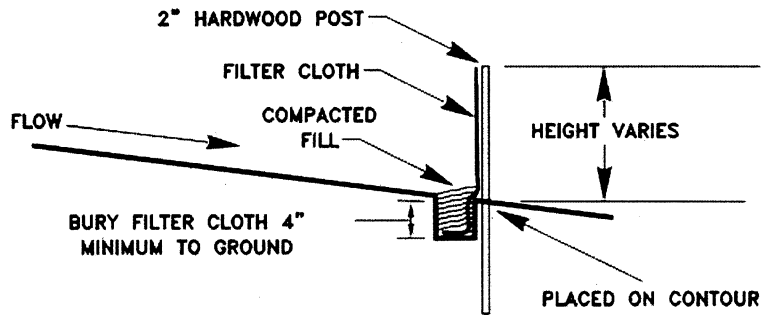
FIGURE 6.2

# SILT FENCE

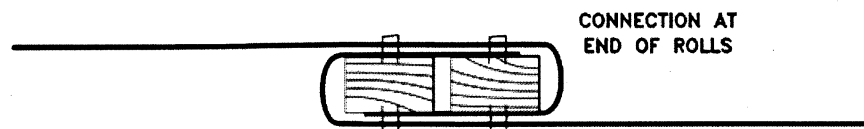
NOTE:  
THE MAXIMUM LENGTH  
OF SLOPE ABOVE  
A ROW OF SILT  
FENCE IS 110'



## FRONT ELEVATION



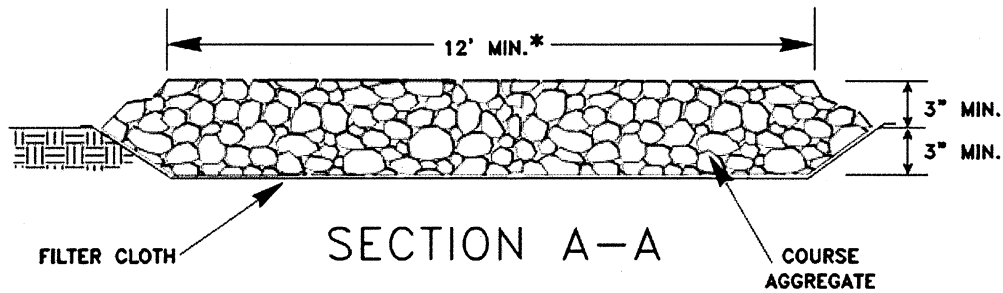
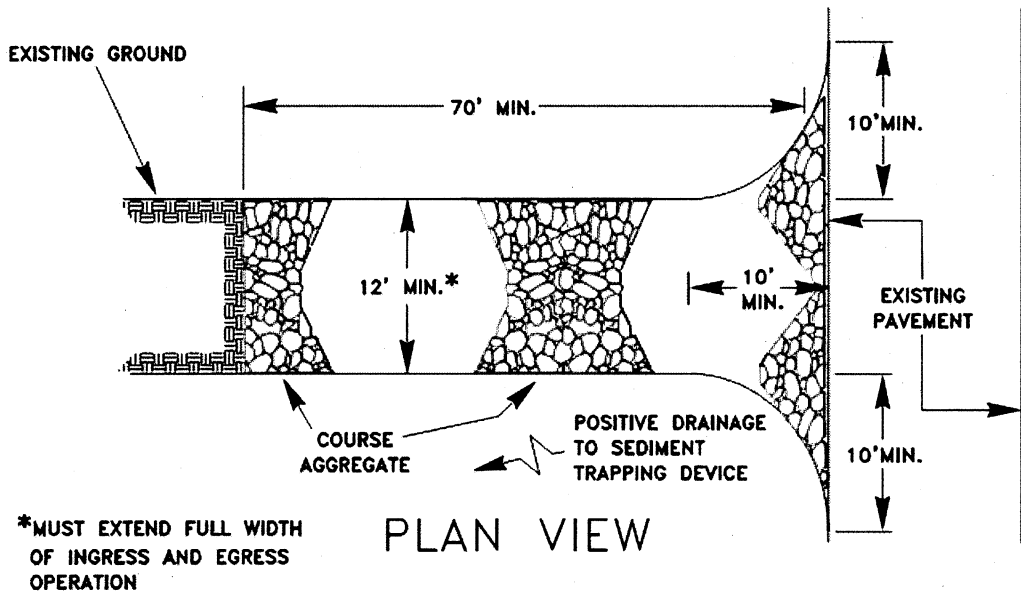
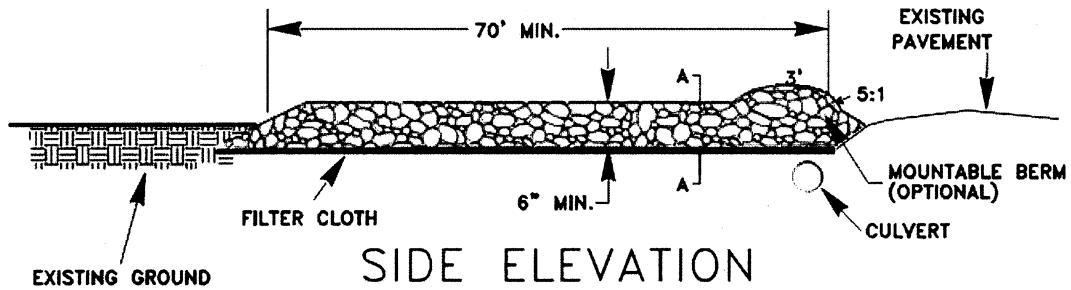
## SIDE ELEVATION



## TOP VIEW

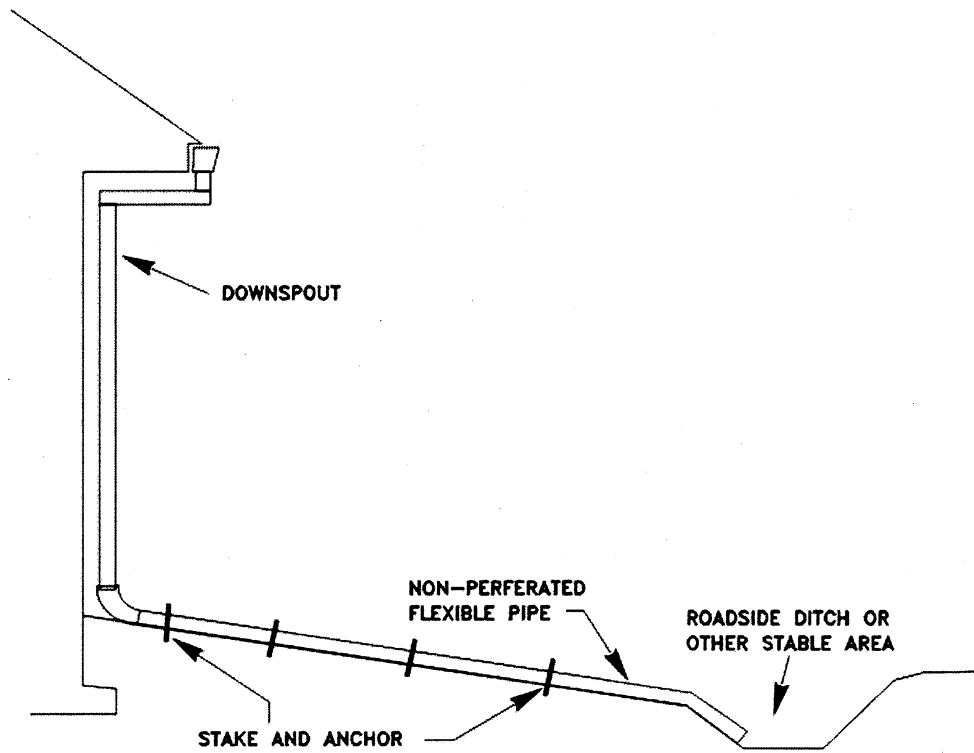
FIGURE 6.3

# STONE CONSTRUCTION ENTRANCE



SOURCE: ADAPTED from 1985 Maryland Standards for Soil Erosion and Sediment Control and Va. DSWC

FIGURE 6.4



# CHAPTER 7

## STREAM RESTORATION STANDARD GUIDELINES AND SPECIFICATIONS

## Chapter 7 – Stream Restoration BMPs

---

### *Introduction*

The Natural Stream Design (NSD) approach to stream restoration uses the characteristics of a stable stream to design the restoration of an unstable one. Some of the stream characteristics that should be identified are the bed and bank materials (clay, sand, gravel, cobble and bedrock), stream pattern, channel gradient, dimension and size of the floodplain.

NSD projects require federal and state permits for in-stream construction. Therefore, NSD projects are thoroughly reviewed by the resource agencies to assure that the project will have a net positive benefit on the aquatic resource. The NPDES program was designed to eliminate and/or dramatically reduce stormwater and associated sediment from upland residential, commercial or industrial construction projects from entering the watercourse. NSD projects aim to enhance/restore stable dimensions, patterns, and profiles to stream channels as well as to enhance/restore floodplains and riparian zones. Methods commonly employed involve the construction of new channel reaches, installation of in-stream structures (rock vanes, log vanes, cross vanes, J-hooks) and construction of floodplain benches. These activities take place in or immediately adjacent to the active stream channel. Best Management Practices (BMPs) for upland construction or other in-stream construction projects are not always practical or appropriate for NSD projects. Therefore, a set of BMPs specifically for NSD projects that reduce turbidity to reasonable, practical and acceptable levels during construction of the stream restoration project have been developed. In addition to the BMPs developed for NSD projects, other appropriate BMPs as defined in Chapter Three may be utilized in developing the Storm Water Pollution Prevention Plan (SWPPP).

### *Conditions where Practice Applies*

NSD is a broad term that encompasses a variety of projects that have the common goal of improving the quality of the stream ecosystem. Channelization and dredging to increase the flow capacity of the stream is not considered a NSD-type project. Impacts associated with channel construction such as increased turbidity, disturbance of channel substrates and floodplain alteration can be visually dramatic. However, these temporary impacts are mitigated by long-term restoration of the impaired channel to a more natural stable condition.



***Planning  
Considerations***

NSD projects may be relatively simple habitat improvement projects using structures such as cross vanes designed to improve pool habitat, or simple bank stabilization projects using rock/log vanes. Other NSD projects will be more complex and may physically alter the dimension, pattern, and/or profile of the stream.

**Enhancement Projects** – This category generally includes riparian buffer establishment; non-point source removal activities (livestock exclusion, removal of adjacent agriculture fields from further production, elimination of future timber harvest); bank revegetation; and/or removal or reduction of impervious surfaces in the watershed. The category also incorporates activities that augment channel stability, water quality and stream ecology in accordance with a reference condition where appropriate. These activities may include in-stream and/or streambank activities, but fall short of restoring one or more of the geomorphic variables, which include dimension, pattern and profile. Examples may include stabilization of streambanks using bioengineering techniques; creation of bankfull benches; and introduction of in-stream habitat.

**Restoration Projects** – These projects involve the conversion of an unstable, altered or degraded stream corridor, including adjacent riparian zones (buffers) and flood-prone areas, to a natural stable condition based on historical, recent and future watershed conditions. This process is typically based on a reference condition/reach for the stream valley type and includes restoration of the appropriate geomorphic dimension (cross-section), pattern (sinuosity), and profile (channel slope). This process supports reestablishing physical, biological and chemical integrity, including transport of the water and sediment produced by the stream's watershed in order to achieve dynamic equilibrium.

***Construction  
Criteria***

The following general practices are accepted methods to be used to reduce temporary impacts associated with construction of NSD type projects. These practices are general in nature and some may be included as special conditions in the 404/401 permit. Some general BMP's may have more detailed specifications listed in following sub-sections. Other practices may be approved on a case by case basis.

1. On-site pre-application and/or pre-construction meetings are strongly encouraged to review each project, permit application and the selected BMP(s). These meetings should include the project designer, project sponsor(s), construction contractor(s), USACE, DNR, and DEP permitting and/or enforcement personnel and other appropriate personnel.

2. Clean and inspect equipment prior to arriving on the construction site and before leaving the site to minimize transferring invasive species and contaminating the aquatic system with fluids.
3. If it's necessary for maneuvering equipment prune overhanging vegetation prior to construction. All pruned vegetation should be cut clean.
4. Minimize construction time, and maximize efficiency by:
  - a. Utilizing the proper size, type and quantity of equipment
  - b. Ensuring that the sufficient type, quality and quantity of materials are on-site during construction
  - c. Ensuring sufficient personnel are on-site during construction
  - d. Preparing and following an effective sequence of construction
  - e. Minimizing down time. Once the project is under construction, it should be completed without undue delay.
5. Preserving riparian vegetation (including sod) is critical for minimizing site disturbance, reduction of upland sediment inputs, and post-construction project stability (see appropriate BMPs in Chapter Three).
6. Use upland transportation corridors to minimize impacts to the riparian zone.
7. Work in-the-dry or from the top of bank whenever feasible and practical. Minimize the amount of time and extent of disturbance in the channel as much as possible.
8. Pump-around may be used when feasible and practical.
9. Update field map with minor field modifications daily.
10. While the permit is in effect, project sites must be stabilized according to the approved Erosion and Sediment Control Plan for the 1-year, 24-hour rainfall event, **or bankfull event for NSD projects**. If a storm event exceeds the 1-year, 24-hour rainfall limit **or bankfull**, follow "upset procedures" in General Permit conditions.
11. Practice contemporaneous site reclamation to the extent feasible and practical during construction. Stabilize all

disturbed areas concurrently with restoration activities (see appropriate BMPs in Chapter Three).

12. Follow manufacturer specifications on equipment and materials, or provide the justification to vary from them in NPDES permit application.

## 7.01- IN-STREAM STRUCTURES, RIFFLES AND POOLS

---

### ***Introduction***

In-stream structures, and profile alterations such as riffles and pools, are constructed to provide bank stabilization, habitat enhancement, improved sediment transport and stream restoration. Types of structures may include cross vanes, rock vanes, j-hooks, and possibly log structures. In-stream structures and profile alterations are constructed to provide long-term stability to the stream reach.

### ***Conditions Where Practice Applies***

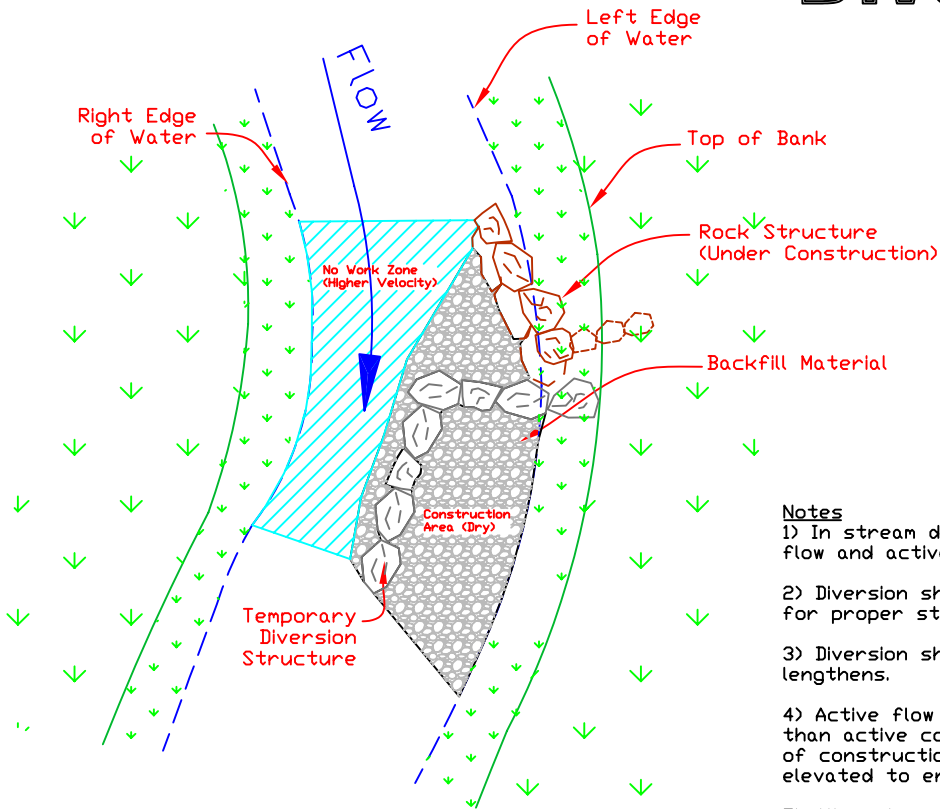
These techniques should be practiced, all or in part, during all phases of stream restoration projects. The practices that are determined most effective and feasible to sediment and erosion control for the specific site should be exercised.

### ***Construction Specifications:***

1. Where practical and feasible, in-stream work should be done on the side of the stream where the structure is being built.
2. Tracks of stationary equipment working in the stream should be parallel to stream flow when practical and feasible, to do so.
3. Minimize drop height when placing material in the channel.
4. Minimize use of temporary stream diversion/deflection structures (see drawings, attached) to reduce additional stream impacts. When used, deflection structures should:
  - a. Deflect flow away from the side of stream where structures are being placed and/or profile is being altered.
  - b. Be composed of native channel material if available adjacent to structure, and if channel material is to be removed anyway. This saves the impact of hauling in clean fill, while also hauling out channel material. If native channel material is not to be removed from an adjacent location, clean non-erodible rock with 15% or less of fines of like material should be imported to build deflection structures.
  - c. Serve as a platform upon which equipment can be stationed to build in-stream structure.
6. Use appropriately-sized equipment to build structures, with hydraulic thumbs to place rock. Equipment that is smaller than necessary will take more time; equipment that is larger than necessary will have more impact on the site.
7. Construction should be sequenced and specified effectively and efficiently to complete the project.

8. Where site conditions permit, turbidity curtains may be utilized per manufacturer's recommendations around structures under construction.
9. Geotextile (woven or non-woven) fabric should be placed behind structures and backfilled in channels with gravel beds (or finer particles).
10. Work in-the-dry or from the top of bank whenever feasible and practical. Minimize the amount and extent of disturbance in the channel as much as possible.
11. Pump-around may be used when feasible and practical.

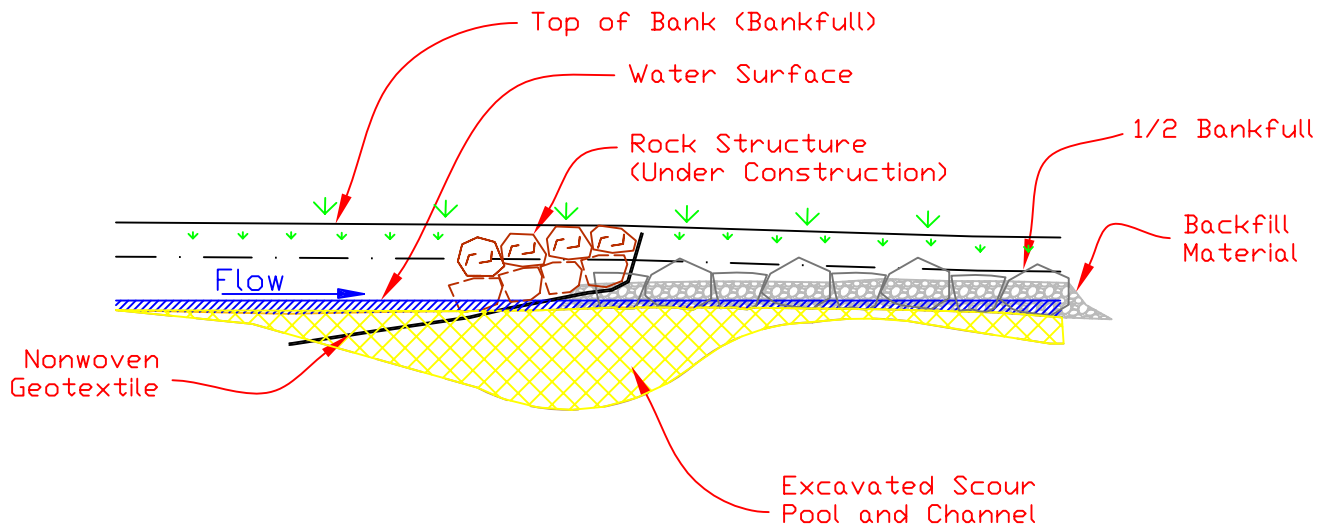
# In Stream Diversion (Dry)



PLAN VIEW

Notes

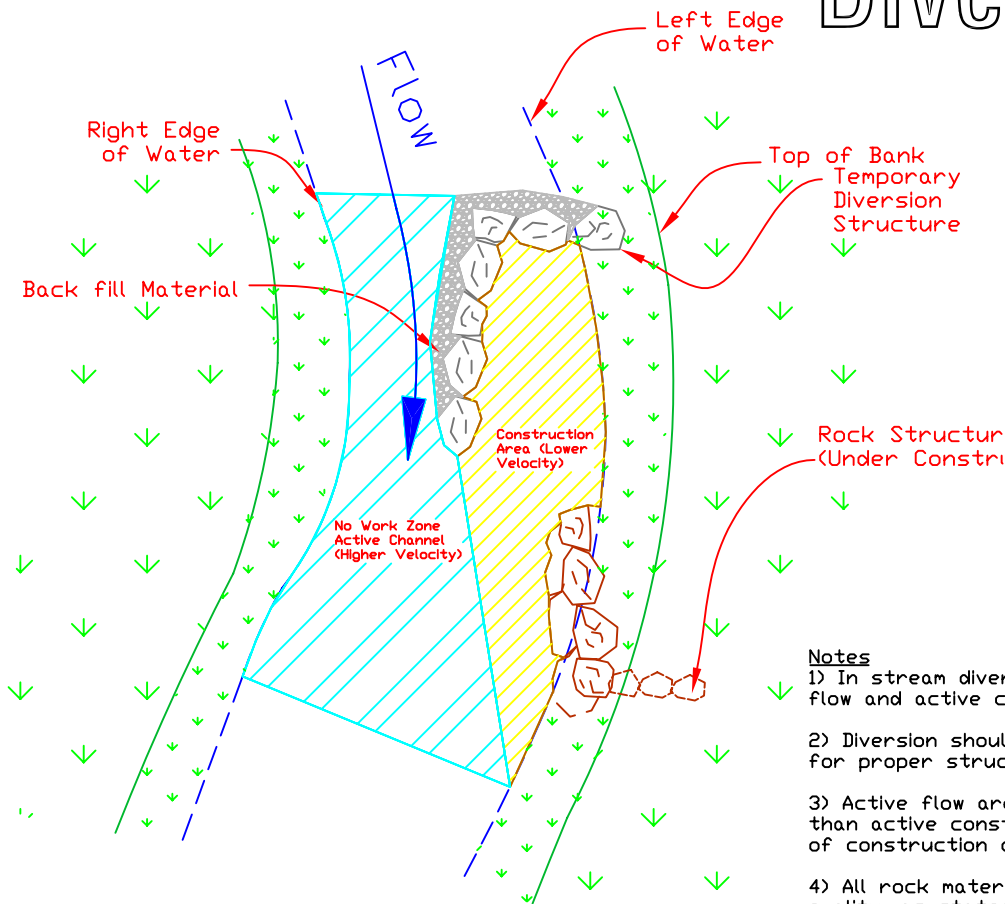
- 1) In stream diversion to act as barrier to the active flow and active construction area.
- 2) Diversion should be placed below structure and allow for proper structure placement.
- 3) Diversion shall expand up stream as structure lengthens.
- 4) Active flow area shall have a thalweg depth greater than active construction area to allow for dewatering of construction area. Active construction area will be elevated to ensure for a dry working area.
- 5) All rock materials shall be of proper size and quality, as stated in construction specifications.
- 6) All rock and fabric material used in construction of diversion shall be removed immediately after completion of project.



PROFILE VIEW

Figure 7.01.2

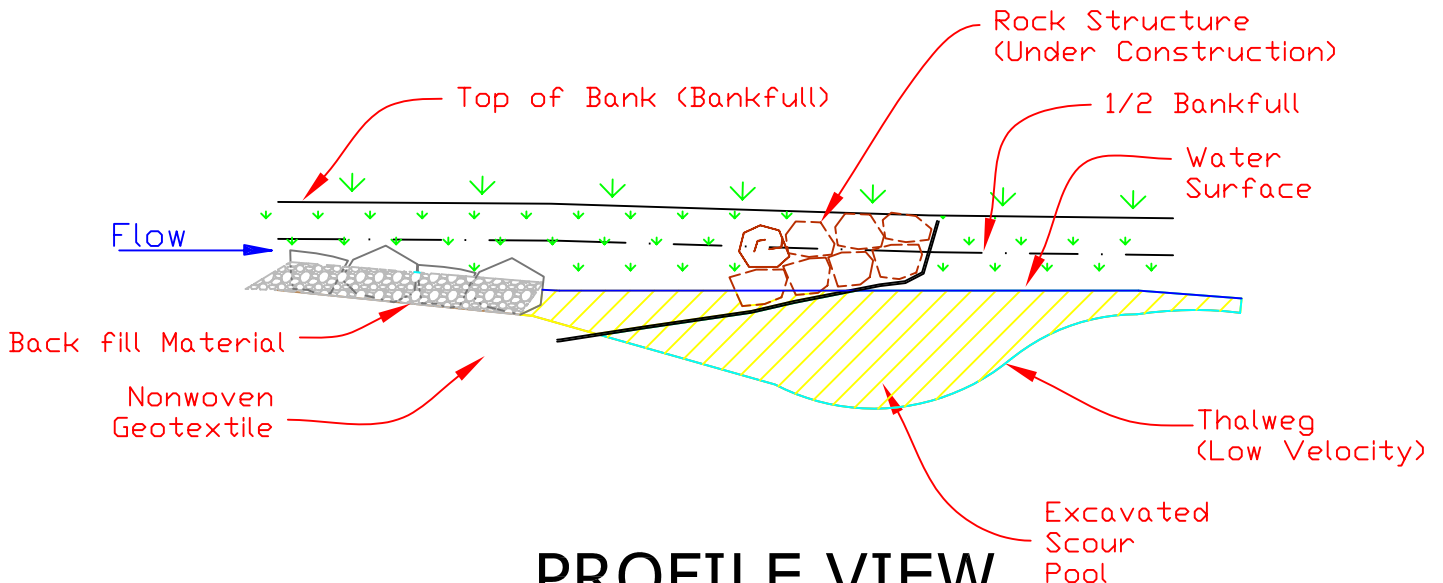
# In Stream Diversion (wet)



**PLAN VIEW**

**Notes**

- 1) In stream diversion to act as barrier to the active flow and active construction area.
- 2) Diversion should be placed above structure and allow for proper structure placement.
- 3) Active flow area shall have a thalweg depth greater than active construction area to allow for dewatering of construction area.
- 4) All rock materials shall be of proper size and quality, as stated in construction specifications.
- 5) All rock and fabric material used in construction of diversion shall be removed immediately after completion of project.



**PROFILE VIEW**

## 7.02 - CONSTRUCTED BENCHES AND FLOODPLAINS

---

### ***Introduction***

Construction of new benches and floodplains improves both the lateral and vertical stability of the reach by allowing the stream to access the floodplain, and reduces the bank height ratio. Stabilizing banks also reduces turbidity from on-going bank erosion. BMPs exercised during construction should be site specific.

### ***Conditions Where Practice Applies***

Minimizing project area disturbance is critical to sediment and erosion control during stream restoration projects. Site specific factors influencing BMPs include quality of riparian buffer, bank material, bed material, bankfull width, bankfull depth, floodprone width, stream gradient, discharge and bank height.

### ***Construction Specifications***

1. New bankfull benches and floodplains should be seeded and mulched. Choose seed appropriate to season, region and site conditions (see appropriate BMPs in Chapter Three).
2. Install berms or silt fences along transportation routes on new benches or floodplains.
3. When constructed benches are composed of fine soils, they should be back-sloped away from the channel (using a slope of 20:1) until final grading and seeding. The back-sloped areas should be drained into ditches or sumps. Any dewatering must be through appropriate devices (see appropriate BMPs in Chapter Three).
4. Stabilize bench and floodplain slopes, and justify stabilization method according to slope material.



## 7.03 – NEW CHANNEL CONSTRUCTION

---

### ***Introduction***

Restoring natural pattern, dimension and profile may sometimes require the construction of an entirely new stream channel, or sections of new channel tied into the existing channel. Building new channel is often combined with creating suitable floodplain and establishing a riparian zone. The new stream channel will be constructed with a stable pattern and profile and appropriate dimensions based on reference conditions and design parameters. The new floodplain and riparian zone will also be established based on site and reference conditions, and will support the physical, biologic, and chemical restoration goals of the project. The construction of the new channel and floodplain must incorporate BMPs to control stormwater and associated sediment inputs.

### ***Conditions Where Practice Applies***

This restoration alternative should be applied to any new channel construction or relocation.

### ***Construction Specifications***

1. Construction should occur “in the dry”, out of the existing flow, whenever possible.
2. Construction should be sequenced to effectively and efficiently complete the project.
3. When constructed benches are composed of fine soils, they should be back-sloped away from the channel (using a slope of 20:1) until final grading and seeding. The back-sloped areas should be drained into ditches or sumps to pump out, as necessary. Follow existing NPDES permit requirements about filtering all pumped discharge into streams.
4. Install sediment and erosion control at downstream end of active construction zone.
5. Stabilize new channel and bank slopes before releasing flow into the new channel, and justify stabilization method according to slope material.
6. Where feasible, release of the flow into the new channel should be a staged process. This can be accomplished by gradually removing the barrier between the old and the new channel, which allows more control of the stream flow.
7. If the abandoned channel will be backfilled, the process should proceed from upstream to downstream, and existing BMPs for seeding and mulching should be followed (Chapter Three). If the abandoned channel will not be backfilled, it must be stabilized.

8. Material excavated from the new channel should be placed in stockpile area(s) with appropriate sediment and erosion control, and utilized or disposed of in accordance with permittee's NPDES registration.
9. Disturbance to riparian vegetation adjacent to the new stream channel should be minimized when possible.

## 7.04 –TRANSPORTING MATERIALS ON THE STREAM BED

---

### ***Introduction***

Preserving riparian vegetation (including sod) is critical in minimizing site disturbance, upland sediment and turbidity inputs. Depending on local site conditions, constructing the access road along the riparian corridor may result in greater impacts than using sections of the stream bed to transport material. Examples of local site conditions where transporting material on the stream bed may be justified include but are not limited to infrastructure or other physical constraints that restrict transportation activities beyond the stream channel, critical and/or fragile riparian environments, and impact-resistant stream beds composed of bedrock or cobble. Any use of the stream bed as a route to transport materials must be clearly justified and explained in the NPDES permit application. If transporting materials on the stream bed would create considerable turbidity issues, the use of multiple stream access points may be a suitable alternative (see appropriate BMPs in Chapter Three).

### ***Conditions Where Practice Applies***

The use of the stream bed as a route for transportation of materials is limited to stream beds composed of bedrock, cobble, or large gravel, and where a transportation route on the stream bed will cause less impact than a transportation route in adjacent uplands.

### ***Construction Specifications***

When using the stream bed as a route to transport materials:

1. Use equipment of the appropriate type and size to transport material efficiently and effectively. Equipment must be no wider than the bottom width of the channel.
2. Equipment with low ground pressure is recommended to minimize stream impacts.
3. Inspect equipment daily. Low toxicity oil and coolant is recommended.
4. Limit transportation to low-flow periods (considering both daily and seasonal conditions).
5. Keep equipment out of the water where possible.
6. Limit transportation activities to one route in any single stream reach.
7. Minimize the number of turns and trips in the channel.
8. Minimize transportation activities in the rain.

9. Limit the number of stream access points and crossings to the fewest possible.
10. Locate, design and construct stream access points to minimize erosion and sedimentation into the stream. Provide adequate sediment and erosion control at stream access points.
11. Plan material storage areas and transportation routes to allow work to be done in an efficient and effective manner.
12. Stabilize all stream access and turn-around points immediately following the completion of the in-stream work.

# **CHAPTER 8**

## **STEEP SLOPE CONSTRUCTION GUIDELINES IN AREAS OF HIGH SLIP POTENTIAL SOILS**

# Chapter 8 – Steep Slope Construction Guidelines in areas of High Slip Potential Soils

## *Introduction*

Landslide issues at many construction sites in West Virginia illustrate the importance making some changes to the storm water permitting process in order to identify potential problems and incorporate additional requirements to reduce the number of future slips.

## *Conditions Where Practice Applies*

High slip potential soils are a key factor with the majority of slips at construction projects in West Virginia (see **Appendix D** for table showing West Virginia High Slip Potential Soils by County).

## *Planning Considerations*

Dewatering a critical slope is usually simple, cost efficient and will potentially provide an effective means to stabilize a slope and prevent slips.

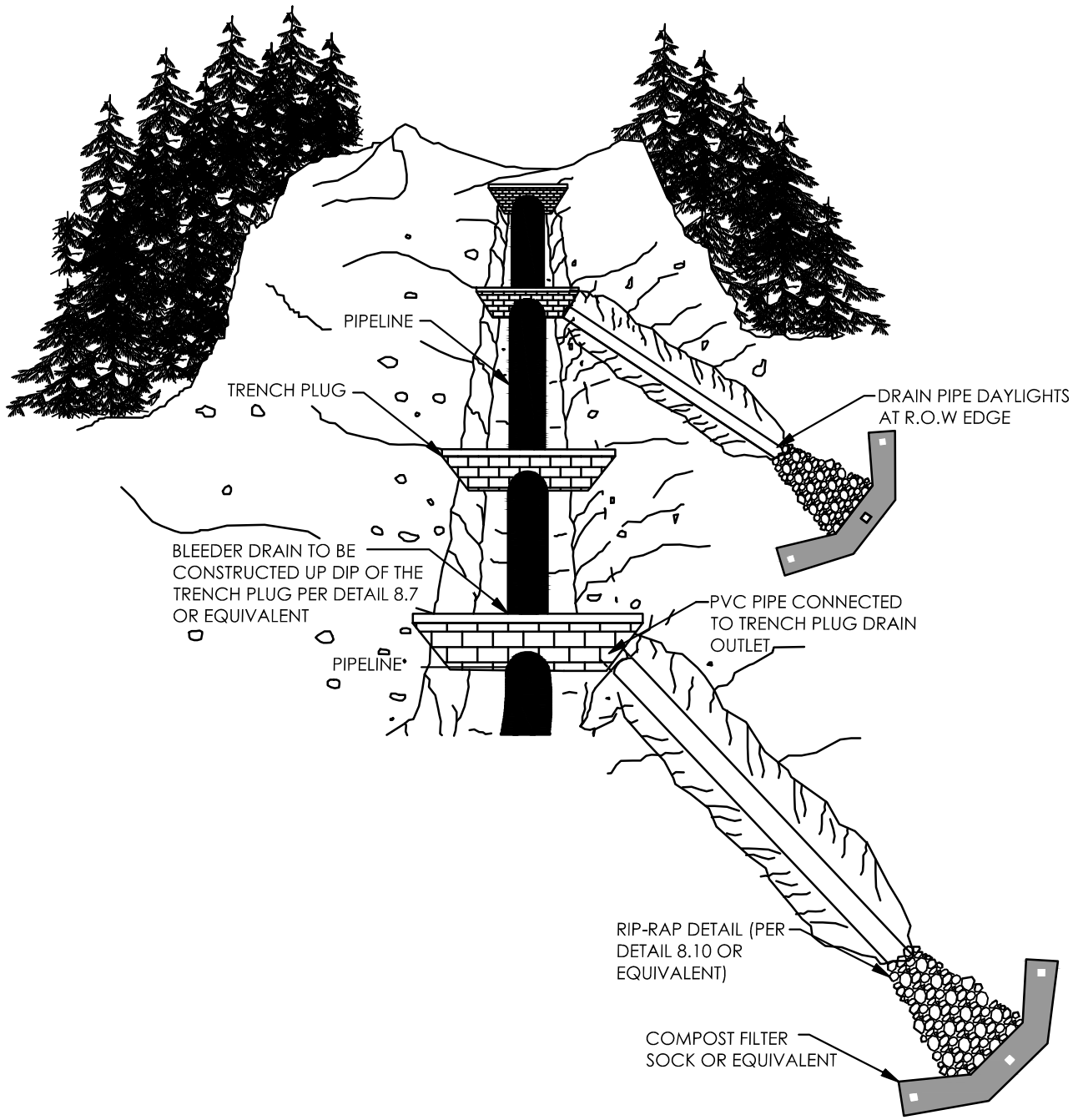
The following provides a description of BMP's employed to protect slopes in high slip potential areas at or greater than 3:1 and to minimize soil erosion and/or slips due to seeps, springs and surface runoff that can percolate into soil strata during and after earth disturbance and trenching excavation. This moisture infiltration has the potential to cause slips by saturating the soils resulting in lower resistance to movement while decreasing the angle of repose. The methods proposed for water management is to direct flows away from potentially unstable areas by installing horizontal drains to passively drain water from the slope area and prevent saturation of slope materials. The following construction criteria is technical guidance on the design of bleeder drains however on a case by case basis, other techniques may be satisfactory.

***Construction  
Criteria***

There are three (3) areas where these drains will be required:

1. In order to avoid the consequences of a “dam” behind trench plugs caused by ground water or surface water infiltrating the backfilled trench, water management is required to prevent soil saturation of the trench area by installing passive bleeder drains. (See Exhibits 8.4 thru 8.7 for bleeder drain illustrations).
2. A drain shall be installed at low topographical areas where the existing ground slopes perpendicular to the ROW are greater than 3:1 and with significant contributing drainage area Two (2) acres or more. (See Exhibits 8.8 and 8.9).
3. A drain shall be installed at seepage areas encountered during construction and positioned upslope from backfilled trench to intercept water before it seeps into the backfilled trench. (See Exhibits 8.11 and 8.12).

Where trenching activities are proposed in high slip potential soils and in areas where existing ground slopes are greater than 3:1, bleeder drains shall be installed to passively drain water from the trench area. The following illustration shows a drain placed at every second trench plug.

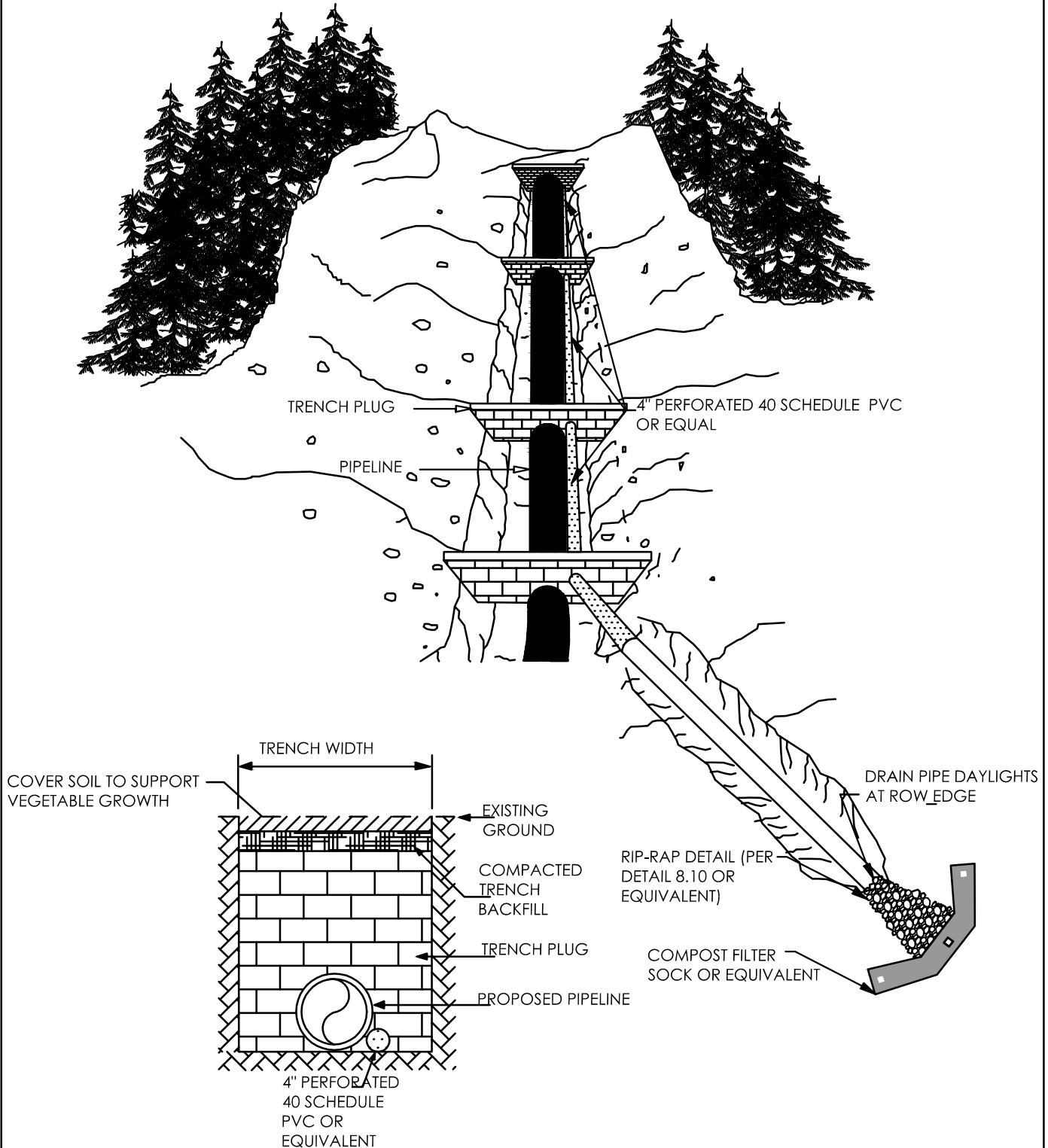


NOT TO SCALE

## SLIP PREVENTION: BLEEDER DRAIN AND OUTLET DETAIL



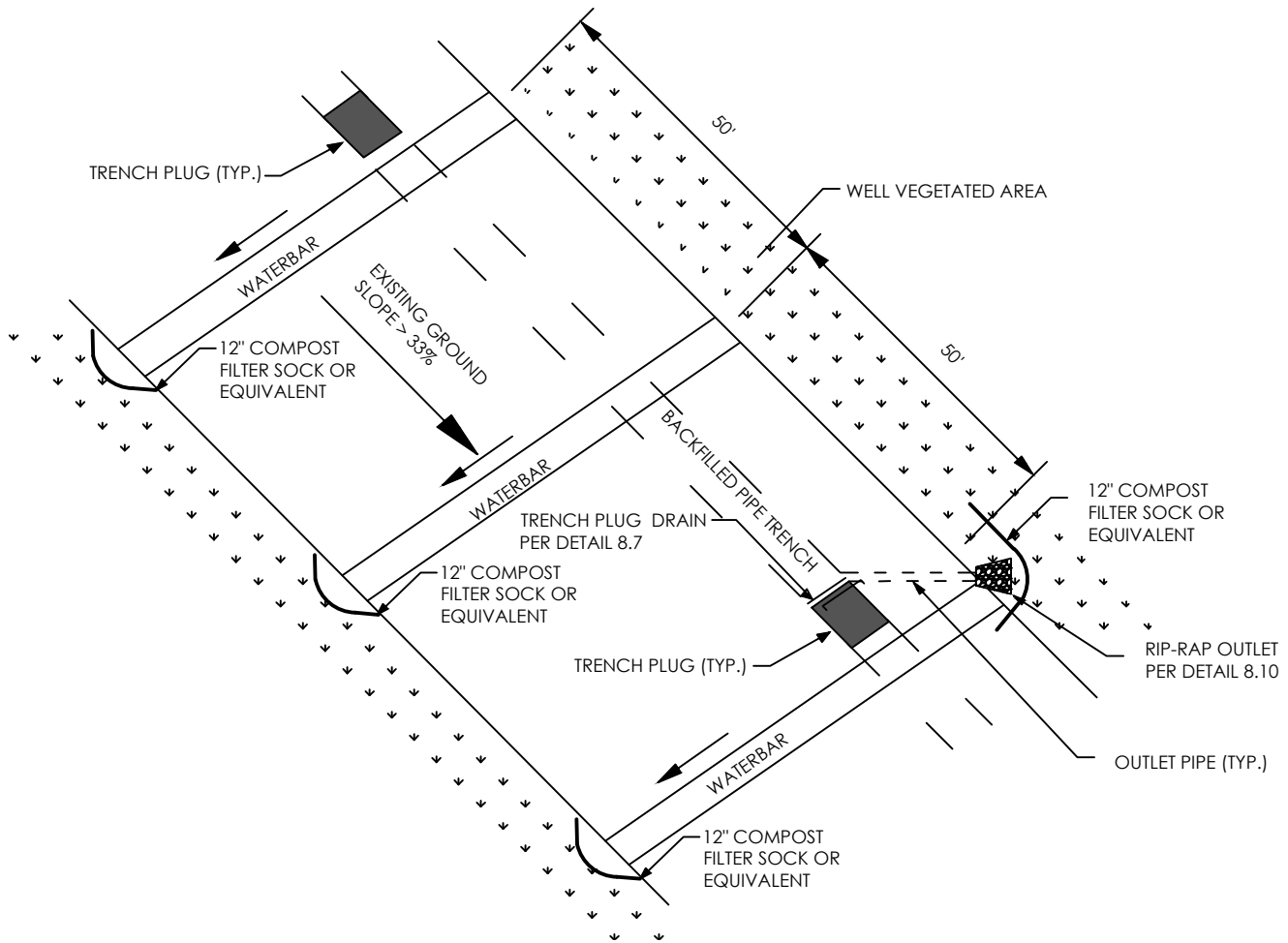
A bleeder drain placed parallel along the pipeline is an effective way to passively drain water from the backfilled trench area. This technique will reduce the number of outlets and control the placement of outlets. The following illustration shows this method.



NOT TO SCALE

**SLIP PREVENTION: BLEEDER DRAIN PARALLEL TO PIPELINE**

The outlets associated with pipeline trench drains are typically used in conjunction with right-of-way diversions. Used in this manner, additional outlets and sediment filter controls will not be needed. Spacing for trench plugs in high slip potential soils is related to the severity of the ROW slopes. Trench plug drains shall be installed at every other trench plug on slopes that are 30% or greater.



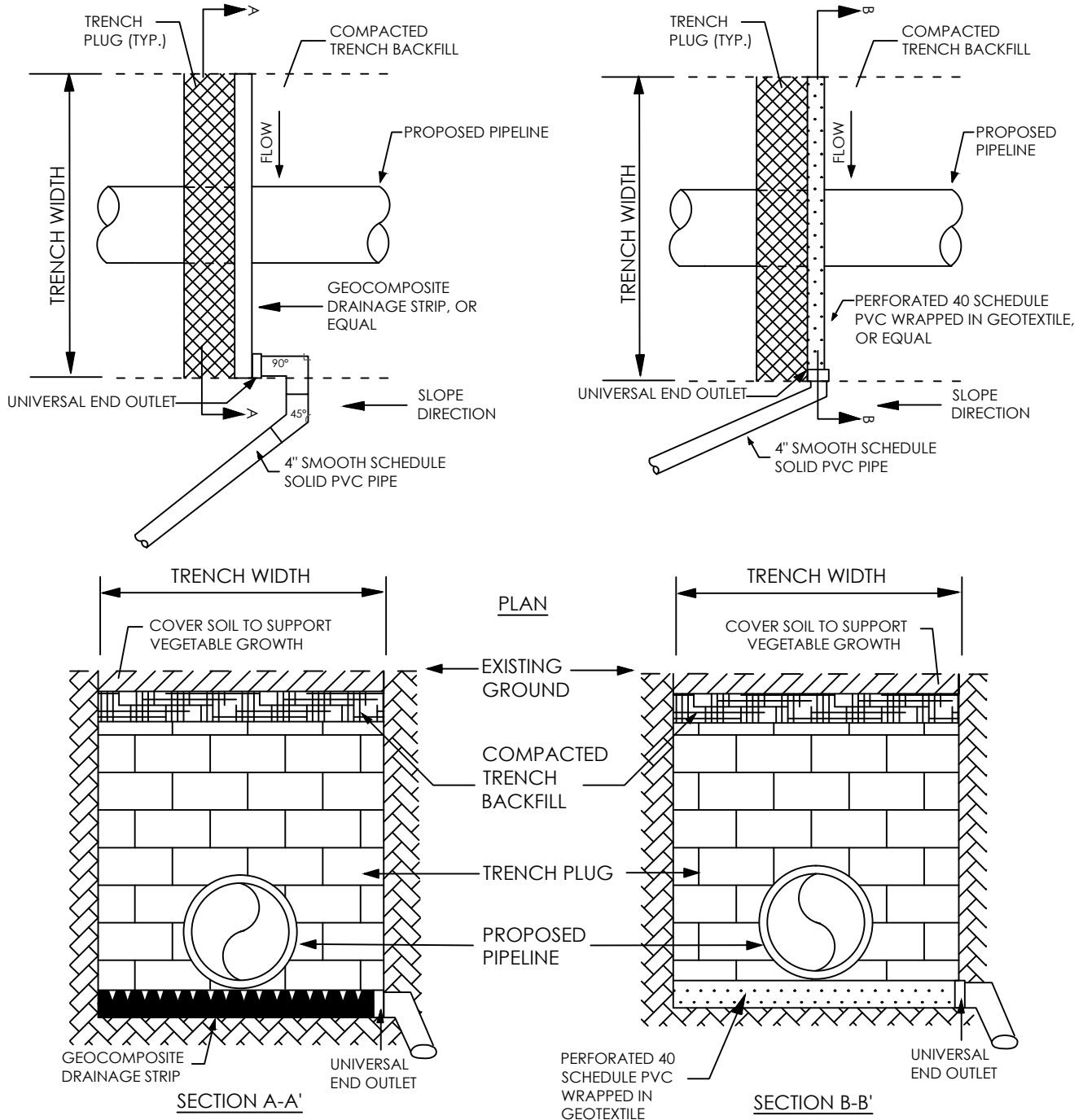
**Spacing of Trench Plugs (Drains to be installed at every other Plug)**

Percent Slope	Spacing in Feet
<5	*
5 - 15	500
15 - 25	300
25 - 35	200
➤ 35	100

NOT TO SCALE

**SLIP PREVENTION: TRENCH PLUG DRAIN OVERVIEW**

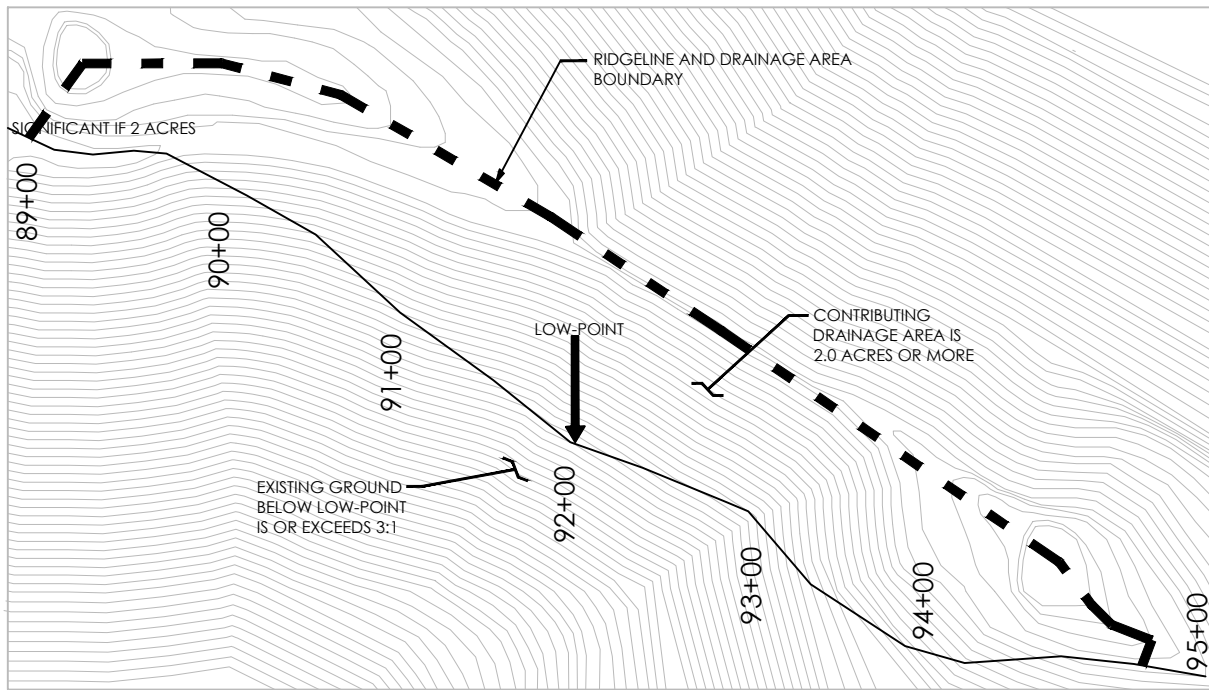
Two (2) types of trench plug drains are illustrated below. Geocomposite Drainage Strips or Perforated Schedule 40 PVC placed behind the trench plug and below the pipeline are effective ways to passively drain water. Both methods show Schedule 40 PVC discharge pipe at a minimum of a 2% grade.



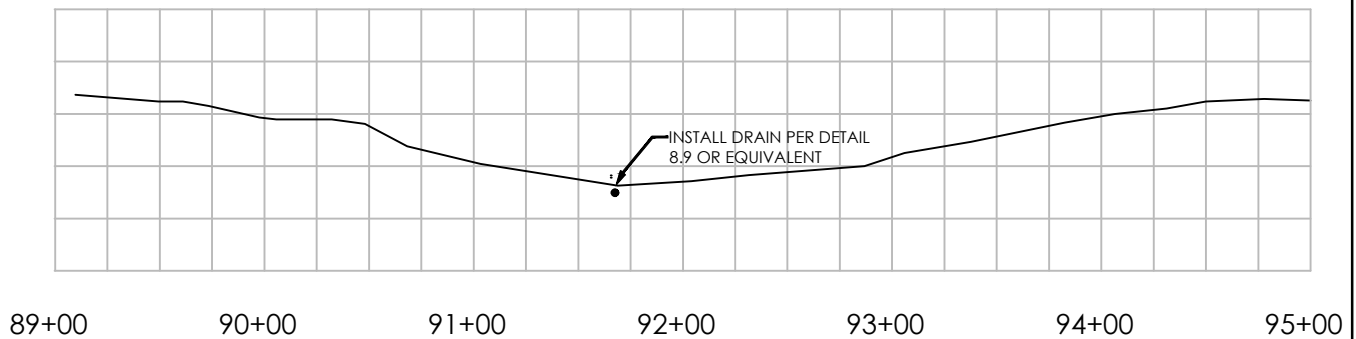
NOT TO SCALE

## SLIP PREVENTION: TRENCH PLUG DRAIN DETAILS

Bleeder drains will sometimes be required at low points associated with side hill construction activities in high slip potential soils. Drainage from the undisturbed profile can infiltrate the backfilled soil within the trench and drain to a low point with the potential of saturating the soil. A drain shall be installed at low topographical areas where the existing ground slopes perpendicular to the ROW are greater than 3:1 and with significant contributing drainage area two (2) acres or more. Unusual conditions will be reviewed on a case by case basis.



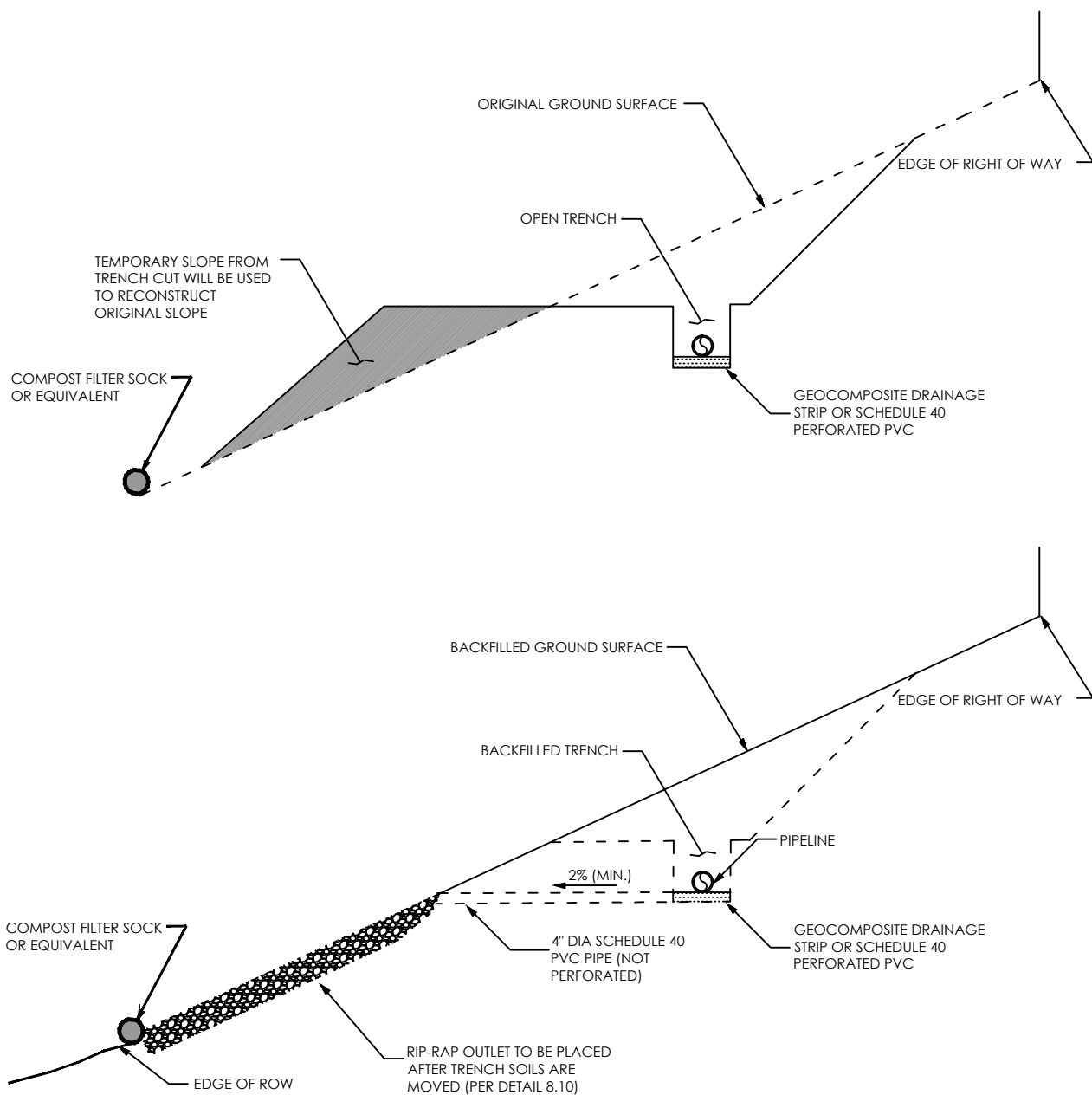
PROPOSED PIPELINE PLANVIEW



PROPOSED PIPELINE PROFILE

**SLIP PREVENTION: SIDE HILL CONSTRUCTION**

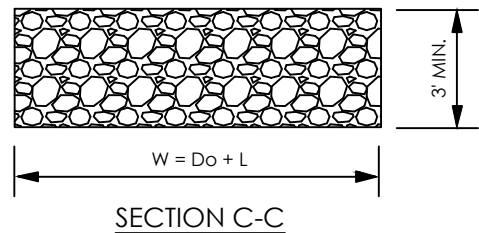
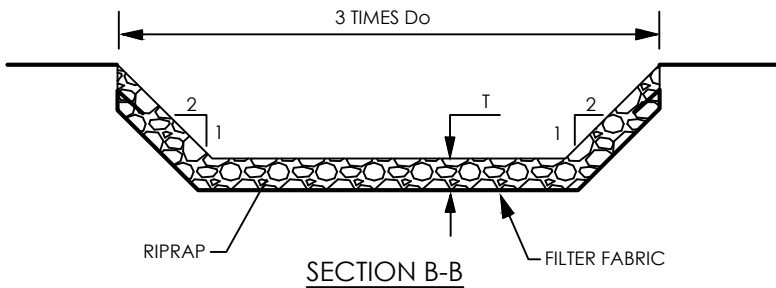
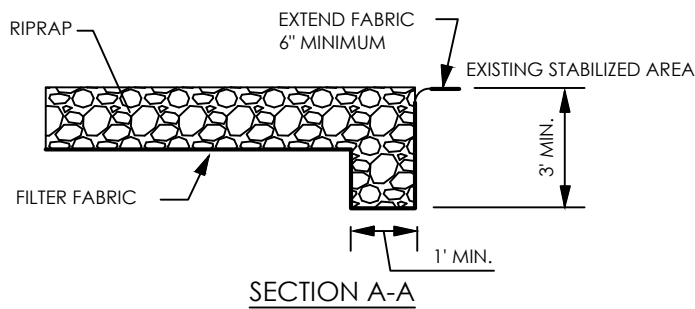
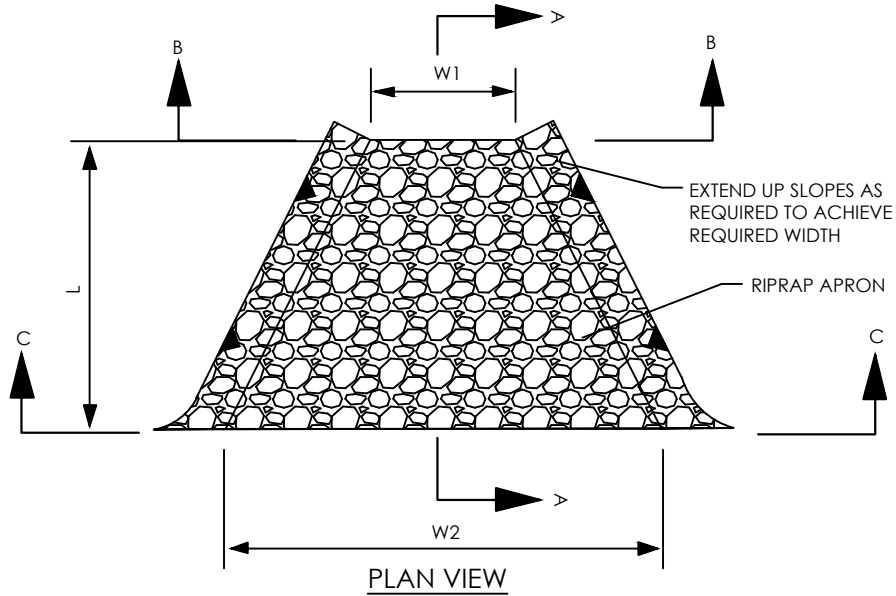
Two (2) types of low point drains are illustrated below. Geocomposite Drainage Strips or Perforated Schedule 40 PVC placed below the pipeline are effective ways to passively drain water. Both methods show Schedule 40 PVC discharge pipe at a minimum of a 2% grade.



NOT TO SCALE

## SLIP PREVENTION: SIDE HILL CONSTRUCTION DRAIN

Outlet protection structures prevent scour and erosions at discharge outlets by dissipating the energy and reducing velocities. The illustration below show a typical application of an apron lined with rock riprap.

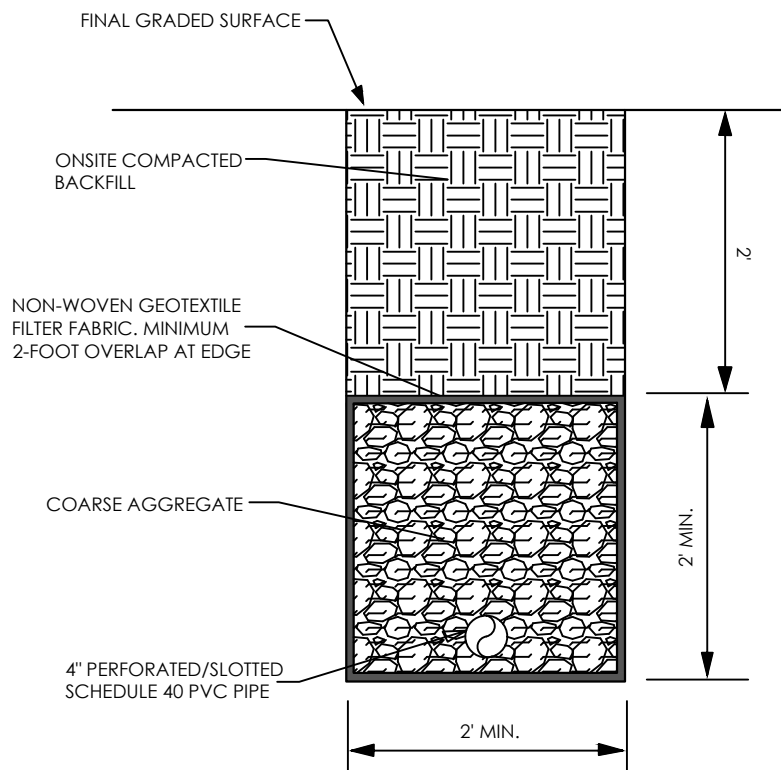


APRON ID	L* (FT)	W1 (FT)	W2 (FT)	D50 (IN)	T (FT)	RIPRAP	CY OF STONE
DRAIN OUTLET	4	2	6	3	1	R-3	2.00

NOT TO SCALE

## SLIP PREVENTION: DRAIN OUTLET RIP-RAP OUTLET

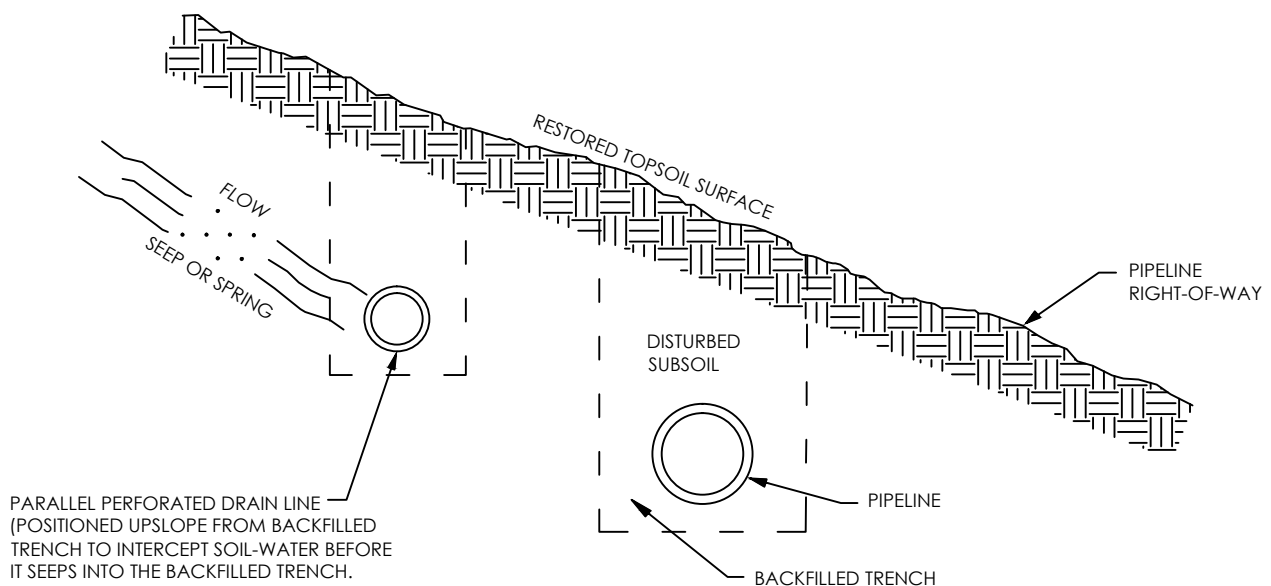
French drains can be constructed to passively drain water away from the trench area. These drains can be installed at seepage areas encountered during construction. These drains should be sloped at a minimum of 2% to the outlet locations



NOT TO SCALE

### SLIP PREVENTION: SUBSURFACE DRAIN (FRENCH DRAIN)

Parallel drainage tiles can be installed at seepage areas encountered during construction. The drains may be perforated PVC or geocomposite drain strips placed between the seepage area and the pipeline to intercept soil-water before it seeps into the open or backfilled trenchline. These drains should be sloped at a minimum of 2% to the outlet locations.



NOT TO SCALE

## SLIP PREVENTION: SEEP INTERCEPT DRAIN PARALLEL TO TRENCH



APPENDIX A  
GLOSSARY

# GLOSSARY

---

**AASHTO** - American Association of State Highway & Transportation Officials (Formerly AASHO.)

**ACCEPTABLE OUTLET** - That point where storm water runoff can be released into a watercourse or drainage way of adequate capacity without causing scour or erosion.

**ACID SOIL** - A soil giving an acid reaction throughout most or all of the portion occupied by roots. (Precisely, below a pH of 7.0; practically, below a pH of 6.6.)

**ALLUVIAL FAN** - A sloping, fan shaped mass of sediment deposited by a stream where it emerges from an upland onto a plain.

**ALLUVIUM** - A general term for all detrital material deposited or in transit by streams, including gravel, sand silt, clay and all variations and mixtures of these. Unless otherwise noted, alluvium is unconsolidated.

**ANGLE OF REPOSE** - The stable angle between the horizontal and the maximum slope that a soil assumes through natural processes that will not slough.

**ANTI-SEEP COLLAR** - An impermeable diaphragm usually of sheet metal or concrete constructed at intervals within the zone of saturation along the conduit of a principal spillway to increase the seepage length along the conduit and thereby prevent piping or seepage along the conduit.

**ANTI-VORTEX DEVICE** - A device, usually a vertical or horizontal plate, carefully designed and placed at the entrance of a pipe to prevent the formation of a vortex in the water at the pipe entrance.

**APRON** - A floor or lining to protect a surface from erosion, for example, the pavement below chutes, spillways, or at the toes of dams.

**ASPECT** - The direction a slope faces - a physiographic feature of steep slopes which influences plant growth and adaptation.

**ATTERBERG LIMITS** - Atterberg limits are soil properties measured for soil materials passing the No. 40 sieve.

**Liquid Limits (LL)** - the liquid limit is the water content corresponding to the arbitrary limit between the liquid & plastic states of consistency of a soil.

**Plastic Limits (PL)** - The plastic limit is the water content corresponding to an arbitrary limit between the plastic and semisolid states of consistency of a soil.

**Plasticity Index (PI)** - The plasticity index is the numerical difference between the liquid limit and plastic limit.

**BAFFLES** - Vanes, guides, grids, grating or similar devices placed in a conduit to deflect or regulate flow and effect a more uniform distribution of velocities.

**BARREL** - The usually mild sloping closed conduit used to convey water under or through a dam; part of a principal spillway.

**BASE FLOW** - The stream discharge from ground water accretion.

**BEDLOAD** - The sediment that moves by sliding, rolling or bounding on or very near the streambed; sediment moved mainly by tractive or gravitational forces or both but at velocities less than the surrounding flow.

**BERM** - A shelf that breaks the continuity of a slope.

**BIODEGRADABLE** - Capable of being broken down (degraded) by common soil organisms.

**BLIND DRAIN** - A type of drain consisting of an excavated trench refilled with pervious material, such as coarse sand, gravel or crushed stone, through whose voids water percolates and flows to an outlet. Often referred to as a French drain because of its initial development and widespread use in France.

**BRACKISH (WATER)** - Slightly to moderately salty water.

**BULKHEAD** - A wall made from wood, steel, concrete, etc. for protection of shoreline from waves or currents.

**CALCIUM SULFATE** - Gypsum. A hydrated form used to treat high sodium soils.  $\text{CaSO}_4$

**CHANNEL** - A natural stream that conveys water; a ditch or channel excavated for the flow of water.

**CHANNEL IMPROVEMENT** - The improvement of the flow characteristics of a channel by clearing, excavation, realignment, lining, or other means in order to increase its water carrying capacity.

**CHANNEL STABILIZATION** - Erosion prevention and stabilization of velocity distribution in a channel using jetties, drops, revetments, structural linings, vegetation and other measures.

**CHANNEL STORAGE** - Water temporarily stored in channels while en route to an outlet.

**CHECK DAM** - A small dam construction in a gully or other small watercourse to decrease the stream flow velocity (by reducing the channel gradient), minimize channel scour, and promote deposition of sediment.

**CHUTE** - A high velocity, open channel for conveying water to a lower level without erosion.

**CLAY (SOILS)** - 1. A mineral soil separate consisting of particles less than 0.002 millimeter in equivalent diameter. 2. A soil texture class. 3. (Engineering) A fine grained soil (more than 50 percent passing the No. 200 sieve) that has a high plasticity index in relation to the liquid limit. (Unified Soil Classification System)

**COMPACTION** - To unite firmly. With respect to construction work with soils, engineering compaction is any process by which the soil grains are rearranged to decrease void space and bring them into closer contact with one another, thereby increasing the weight of solid material per unit of volume, increasing the shear and bearing strength and reducing permeability.

**CONDUIT** - Any channel intended for the conveyance of water, whether open or closed.

**CONTOUR** - 1. An imaginary line on the surface of the earth connecting points of the same elevation. 2. A line drawn on a map connecting points of the same elevation.

**COOL (SLOPE EXPOSURE)** - A slope facing north or east, or a slope shaded during the hot part of the day.

**CORE TRENCH** - A trench, filled with relatively impervious material intended to reduce seepage of water through porous strata.

**CRADLE (ENGINEERING)** - A structure usually of concrete shaped to fit around the bottom and sides of a conduit to support the conduit, increase its strength and in dams, to fill all voids between the underside of the conduit and the soil.

**CREST** - 1. the top of a dam, dike, spillway or weir, frequently restricted to the overflow portion. 2. The summit of a wave or peak of a flood.

**CRITICAL AREA OR SITE** - Sediment producing, highly erodible or severely eroded areas.

**CRITICAL DEPTH (HYDRAULICS)** - Depth of flow in a channel of specified dimensions at which specific energy is a minimum for a given discharge.

**CROWN (OF SLOPE)** - Top of slope; apex.

**CRUSHED STONE** - Aggregate consisting of angular particles produced by mechanically crushing rock.

**CULM** - The stem of grasses, sedges and rushes which is jointed and usually hollow in grasses and usually solid in sedges and rushes.

**CULTIPACKER SEEDER** - A farm tool equipped with a seed box which drops the seed between cultipacker rollers to place the seed to firm soil where they will be pressed into soil by the second corrugated roller.

**CUT** - Portion of land surface or area from which earth has been removed or will be removed by excavation; the depth below original ground surface to excavated surface.

**CUT-AND-FILL** - Process of earth moving by excavating part of an area and using the excavated material for adjacent embankments or fill areas.

**CUTOFF** - A wall or other structure, such as a trench, filled with relatively impervious material intended to reduce seepage of water through porous strata.

**CUTTINGS** - A small shoot cut from a plant to start a new plant.

CYCLONE (SEEDER) - A hand turned or tractor drawn seeder that broadcasts seed onto the seed bed by a rotary motion that slings the seed outward from the seeder.

DAM - A barrier to confine or raise water for storage or diversion, to create a hydraulic head, to prevent gully erosion, or for retention of soil, sediment or other debris.

DEBRIS - Broken remains of plants, objects and rocks that form trash or remains.

DECIDUOUS - Plants that shed their leaves annually as opposed to evergreen.

DEPOSITION - The accumulation of material dropped because of a slackening movement of the transporting agent, water or wind.

DESICCATION - Drying out as of root systems of plants before they are planted.

DESILTING AREA - An area of grass, shrubs or other vegetation used for inducing deposition of silt and other debris from slowing water, located above a pond, field or other area needing protection from sediment accumulation. (See filter strip.)

DETENTION DAM - A dam constructed for the purpose of temporary storage of stream flow or surface runoff which releases the stored water at controlled rates.

DIKE (ENGINEERING) - An embankment to confine or control water, for example, one built along the banks of a river to prevent overflow or lowlands; a levee.

DISTURBED AREA - An area in which the natural vegetative soil cover has been removed or altered and, therefore, is susceptible to erosion.

DIVERSION - A channel with a supporting ridge on the lower side constructed across the slope to divert water from areas where it is in excess to sites where it can be used or disposed of safely. Diversions differ from terraces in that they are individually designed.

DOLOMITIC (LIMESTONE) - Liming materials that contain more than 6 percent magnesium (mg); high magnesium lime.

DRAIN (NOUN) - 1. A buried pipe or other conduit (subsurface drain). 2. A ditch or channel (open drain) for carrying off surplus surface water or groundwater.

DRAIN (VERB) - 1. To provide channels, such as open ditches or closed drains, so that excess water can be removed by surface flow or internal flow. 2. To lose water (from the soil) by percolation.

DRAINAGE - 1. The removal of excess surface water or ground water from land by means of surface or subsurface drains. 2. Soils characteristics that affect natural drainage.

DRAINAGE AREA (WATERSHED) - All land and water area from which runoff may run to a common (design) point.

DRAUGHTY (SOIL OR SLOPE) - Lacking moisture during part of the growing season during a typical year.

**DROP INLET SPILLWAY** - An out fall structure in which the water drops through a vertical riser connected to a discharge conduit.

**DROP SPILLWAY** - An out fall structure in which the water drops over a vertical wall onto an apron at a lower elevation.

**DROP STRUCTURE** - A structure for dropping water to a lower level and dissipating surplus energy; a fall. The drop may be vertical or inclined.

**DRY STORAGE** - The 1800 cubic feet of storage in a trap or basin that is dewatered after rain events.

**EMERGENCY SPILLWAY** - A dam spillway designed and constructed to discharge flow in excess of the principal spillway design discharge.

**ENERGY DISSIPATOR** - A designed device such as an apron of rip rap or a concrete structure placed at the end of a water transmitting apparatus such as pipe, paved ditch or paved chute for the purpose of reducing the velocity, energy and turbulence of the discharged water.

**ENTRANCE HEAD** - The head required to cause flow into a conduit or other structure, including both entrance loss and velocity head.

**EROSION** - 1. The wearing away of the land surface by running water, wind, ice, or other geocal agents, including such processes as gravitational creep. 2. Detachment and movement of soil or rock fragments by water, wind, ice or gravity. The following terms are used to describe different types of water erosion:

**Accelerated erosion** - Erosion much more rapid than normal, natural or geological erosion, primarily as a result of the influence of the activities of man or, in some cases, of other animals or natural catastrophes that expose base surfaces, for example, fires.

**Gully erosion** - The erosion process whereby water accumulates in narrow channels and, over short periods, removes the soil from this narrow area to considerable depths, ranging from 1 or 2 feet to as much as 75 to 100 feet.

**Rill erosion** - An erosion process in which numerous small channels only several inches deep are formed. See rill.

**Sheet erosion** - The spattering of small soil particles caused by the impact of raindrops on wet soils. The loosened and spattered particles may or may not subsequently be removed by surface runoff.

**EROSIVE VELOCITIES** - Velocities of water that are high enough to wear away the land surface. Exposed soil will generally erode faster than stabilized soils. Erosive velocities will vary according to the soil type, slope, structural or vegetative stabilization used to protect the soil.

**ESTHETIC (AESTHETIC)** - Pleasing in appearance; showing good taste.

**EVERGREEN** - Plants that have leaves or needles yearlong as opposed to those that lose their leaves during part of the year.

**EXCELSIOR BLANKET** - An erosion retardant material made from excelsior strands held together with net like stands of plastic or other material.

**EXPOSURE (SLOPE)** -

North - Slopes facing in any compass direction clockwise between N45W and S45E.

South - Those slopes that face in any compass direction clockwise between S45E and N45W.

**FILTER STRIP** - A strip of permanent vegetation above ponds, diversions and other structures to retard flow of runoff water, causing deposition of transported material, thereby reducing sediment flow.

**FINES (SOIL)** - Generally refers to the silt and clay size particles in soil.

**FREEBOARD (HYDRAULICS)** - The distance between the maximum water surface elevation anticipated in design and the top of retaining banks or structures. Freeboard is provided to prevent overtopping due to unforeseen conditions.

**GABION** - A flexible woven-wire basket composed of two to six rectangular cells filled with small stones. Gabions may be assembled into many types of structures such as revetments, retaining walls, channel liners, drop structures and groins.

**GABION MATTRESS** - A thin gabion, usually six or nine inches thick, used to line channels for erosion control .

**GRADE** - 1. The slope of a road, channel or natural ground. 2. The finished surface of a canal bed, roadbed, top of embankment, or bottom of excavation; any surface prepared for the support of construction, like paving or laying a conduit. 3. To finish the surface of a canal bed, roadbed, top of embankment or bottom of excavation.

**GRAFTING** - A method of propagating plants by joining wood from one plant to another plant to get more desirable growth on the second plant.

**GRASSED WATERWAY** - A natural or constructed waterway, usually broad and shallow covered with erosion resistant grasses, to convey surface water down the slope.

**GRAVEL** - 1. Aggregate consisting of mixed sizes of 1/4 inch to 3 inch particles which normally occur in or near old streambeds and have been worn smooth by the action of water. 2. A soil having particle sizes, according to the Unified Soil Classification System, ranging from the No. 4 sieve size angular in shape as produced by mechanical crushing.

**GRAVEL FILTER** - Washed and graded sand and gravel aggregate placed around a drain or well screen to prevent the movement of fine materials from the aquifer into the drain or well.

**GROIN** - A shore protection structure built (usually perpendicular to the shoreline) to trap littoral drift or retard erosion of the shoreline.

**GROUND COVER** - Plants which are low-growing and provide a thick growth which protects the soil as well as providing some beautification of the area occupied.

**GULLY** - A channel or miniature valley cut by concentrated runoff through which water commonly flows only during and immediately after heavy rains or during the melting of snow. The distinction between gully and rill is one of depth. A gully is sufficiently deep that it would not be obliterated by normal tillage operations, whereas a rill is of lesser depth and would be smoothed by ordinary farm tillage.

**HEAD (HYDRAULICS)** - 1. The height of water above any plane of reference. 2. The energy, either kinetic or potential, possessed by each unit weight of a liquid expressed as the vertical height through which a unit weight would have to fall to release the average energy possessed. Used in various terms such as pressure head, velocity head, and head loss.

**HERBACEOUS PERENNIAL (PLANTS)** - A plant whose stems die back to the ground each year.

**HERBICIDE** - Chemical formulation used to control weeds or brush.

**HULLED (SEED)** - Hullless seed, such as sericea lespedeza. Seed are usually processed after threshing to take off outer hull to facilitate scarification and quicken germination.

**HYDRAULIC GRADE LINE** - In a closed conduit a line joining the elevations to which water could stand in risers or vertical pipes connected to the conduit at their lower end and open at their upper end. In open channel flow, the hydraulic grade line is the free water surface.

**HYDRAULIC GRADIENT** - The slope of the hydraulic grade line. The slope of the free surface of water flowing in an open channel.

**HYDRAULIC JUMP** - The sudden turbulent rise in water level from a flow stage below critical depth to flow stage above critical depth, during which the velocity passes from super critical to sub-critical.

**HYDROGRAPH** - A graph showing variation in stage (depth) or discharge of a stream of water over a period of time.

H-3 1 -6

**HYDROSEEDER** - A machine designed to apply seed, fertilizer, lime and short fiber wood or paper mulch to the soil surface.

**HYDRO-SEEDING** - Seeding with a hydroseeder.

**INFLOW PROTECTION** - A water handling device used to protect the transition area between any water conveyance ( dike, swale, or swale dike) and a sediment trapping device.

**INTERCEPTOR DRAIN** - A surface or subsurface drain, or a combination of both, designed and installed to intercept flowing water.

**LIME** - Basic calcareous materials used to raise pH of acid soils for benefit of plants being grown. May be either ground limestone or hydrated lime.



LITTORAL DRIFT - The sedimentary material moved in the littoral zone under the influence of waves and currents.

MANNING'S FORMULA (HYDRAULICS) - A formula used to predict the velocity of water flow in an open channel or pipeline:

MULCH - Covering on surface of soil to protect and enhance certain characteristics, such as water retention qualities.

MULCH ANCHORING TOOL - A tool that looks like a dull disk designed to press straw and similar mulches into the soil to prevent loss due to wind, water or gravity.

NETTING (MULCH) - Paper or cotton material used to hold mulch material on the soil surface.

NITROGEN - FIXING (BACTERIA) - Bacteria having the ability to fix atmospheric nitrogen, making it available for use by plants. Inoculation of legume seeds is one way to insure a source of these bacteria for specified legumes.

NON-EROSIVE VELOCITY - Controlling the velocity of water to prevent detachment and movement of soil or rock. Erosive velocity will vary according to the soil type, slope, structural or vegetative stabilization used to protect the soil.

NORMAL DEPTH - Depth of flow in an open conduit during uniform flow for the given conditions. (See uniform flow.)

NOXIOUS WEEDS - Harmful; undesirable; hard to control.

a. Restricted - May be sold in the trade but are limited to very small amounts as undesirable connotes.

b. Prohibited - Prohibited from sale.

OUTFALL - The point where water flows from a conduit, stream or drain.

OUTLET - The point at which water discharges from such things as a stream, river, lake, tidal basin, pipe, channel or drainage area.

OUTLET CHANNEL - A waterway constructed or altered primarily to carry water from man-made structures such as terraces, subsurface drains, diversions and impoundments.

OVERFALL - Abrupt change in stream channel elevation; the part of a dam or weir notch over which the weir notch over which the water flows.

PAPER FIBER - A short fiber mulch material usually applied by hydroseeder along with fertilizer and seed.

PARENT MATERIAL - The unconsolidated rock material from which the soil profile develops.

PENDULOUS - More or less hanging or inclined downward.

**PERMANENT SEEDING** - Results in establishing perennial vegetation which may remain on the area for many years.

**PERMISSIBLE VELOCITY (HYDRAULICS)** - The highest average velocity at which water may be carried safely in a channel or other conduit. The highest velocity that can exist through a substantial length of a conduit and not cause scour of the channel. A safe, non-eroding or allowable velocity.

**pH** - A number denoting the common logarithm of the reciprocal of the hydrogen ion concentration. A pH of 7.0 denotes neutrality, higher values indicate alkalinity, and lower values indicate acidity.

**PHREATIC LINE** - The upper surface of the zone of saturation in an embankment is the phreatic (zero pressure) surface; in cross-section, this is called the phreatic line.

**PIPING** - Removal of soil material through subsurface flow channels or pipes developed by seepage water.

**PLUGS** - Pieces of turf or sod, usually cut with a round tube, which can be used to propagate the turf or sod by vegetative means.

**PROJECTION** - In sediment basins or other dams the perpendicular distance that the anti-seep collar extends from the outside surface of the pipe or pipe cradle.

**RECP** – See Rolled Erosion Control Products

**RETENTION** - The amount of precipitation on a drainage area that does not escape as runoff. It is the difference between total precipitation and total runoff.

**REVETMENT** - Facing of stone or other material, either permanent or temporary, placed along the edge of a stream or shoreline to stabilize the bank and to protect it from the erosion action of water.

**RHIZOME** - Any prostrate, more or less elongated stem growing partly or completely beneath the surface of the ground; usually rooting at the nodes and becoming upcurved at the apex.

**RIGHT-OF-WAY** - Right of passage, as over another's property. A route that is lawful to use. A strip of land acquired for transport or utility construction.

**RILL** - A small channel cut by concentrated runoff but through which water commonly flows only during and immediately after rains or during the melting of snow. A rill is usually only a few inches deep (but no more than a foot) and, hence, no obstacle to tillage operations.

**RIP RAP** - Broken rock, cobbles, or boulders placed on earth surfaces, such as the face of a dam or the bank of a stream, for protection against the action of water (waves); also applies to brush or pole mattresses, or brush and stone, or similar materials used for soil erosion control.

**ROLLED EROSION CONTROL PRODUCTS** - Rolled Erosion Control Products (RECPs) are temporary or permanent erosion control nets, blankets and three-dimensional matrixes made from a wide variety of natural (such as jute, coir and straw) and manmade materials alone or in combination.

**ROUGHNESS COEFFICIENT (HYDRAULICS)** - A factor in velocity and discharge formulas representing the effect of channel roughness on energy losses in flowing water. Manning's  $n$  is a commonly used roughness coefficient.

**RUNOFF (HYDRAULICS)** - That portion of the precipitation on a drainage area that is discharged from the area in the stream channels. Types include surface runoff, ground water runoff or seepage.

**SALINE SOIL** - A non-alkali soil containing sufficient soluble salts to impair plant growth.

**SAND** - 1. (Agronomy) A soil particle between 0.05 and 2.0 millimeters in diameter. 2. A soil textural class. 3. (Engineering) According to the Unified Soil Classification System, a soil particle larger than the No. 200 sieve (0.074mm) and passing the No. 4 sieve (approximately 1/4 inch).

**SCD** - Soil Conservation District.

**SEDIMENT** - Solid material, both mineral and organic, that is in suspension, is being transported, or has been moved from its site of origin by air, water, gravity, or ice and has come to rest on the earth's surface either above or below sea level.

**SEDIMENTATION** - Deposition of detached soil particles.

**SEDIMENT DISCHARGE (SEDIMENT LOAD)** - The quantity of sediment, measured in dry weight or by volume, transported through a streamcross-section in a given time. Sediment discharge consists of both suspended load and bedload.

**SEEPAGE** - 1. Water escaping through or emerging from the ground. 2. The process by which water percolates through the soil.

**SEEPAGE LENGTH** - In sediment basins or ponds, the length along the pipe and around the anti-seep collars that is within the seepage zone through an embankment. (See phreatic line.)

**SHA** - Maryland State Highway Administration.

**SHEET FLOW** - Water, usually storm runoff, flowing in a thin layer over the ground surface.

**SIDE SLOPES (ENGINEERING)** - The slope of the sides of a canal, dam or embankment. It is customary to name the horizontal distance first, as 1.5 to 1, or frequently, 1 1/2: 1, meaning a horizontal distance of 1.5 feet to 1 foot vertical.

**SILT** - 1. (Agronomy) A soil separate consisting of particles between 0.05 and 0.002 millimeter in equivalent diameter. 2. A soil textural class. 3. (Engineering) According to the Unified Soil Classification System a fine grained soil (more than 50 percent passing the No. 200 sieve) that has a low plasticity index in relation to the liquid limit.

**SLURRY** - A thickened, aqueous mixture of such things as seed, fertilizer, short fiber mulch or soil.

**SMALL GRAIN MULCH MATERIAL** - Straw material from oats, barley, wheat, or rye.

**SOD** - A piece of earth containing grass plants with their matted roots. Turf.

**SOIL** - 1. (Agronomy) the unconsolidated mineral and organic material on the immediate surface of the earth that serves as a natural medium for the growth of land plants. 2. (Engineering) Earth and rock particles resulting from the physical and chemical disintegration of rocks, which may or may not contain organic matter. It includes fine material (silts and clays), sand and gravel.

**SOIL TEST** - Chemical analysis of soil to determine needs for fertilizers or amendments for species of plant being grown.

**SPECIFIC ENERGY** - The average energy per unit weight of water at a channel section as expressed with respect to the channel bottom.

**SPILLWAY** - An open or closed channel, or both, used to convey excess water from a reservoir. It may contain gates, either manually or automatically controlled to regulate the discharge of excess water.

**SPREADER (HYDRAULICS)** - A device for distributing water uniformly in or from a channel.

**STABILIZATION** - Providing adequate measures, vegetative and/or structural that will prevent erosion from occurring.

**STABILIZED AREA** - An area sufficiently covered by erosion resistant material such as a good cover of grass, or paving by asphalt, concrete, or stone, in order that erosion of the underlying soil does not occur.

**STABILIZED GRADE** - The slope of a channel at which neither erosion nor deposition occurs.

**STABLE (STREAM OR CHANNEL)** - The condition of a stream, channel or other water course in which no erosion or deposition occurs; adequately protected from erosion.

**STAGE (HYDRAULICS)** - The variable water surface or the water surface elevation above any chosen datum.

**STATIC HEAD** - Head resulting from elevation differences, for example, the difference in elevation in headwater and tailwater in a hydroelectric plant.

**STILLING BASIN** - An open structure or excavation at the foot of an outfall, conduit, chute, drop, or spillway to reduce the energy of the descending stream of water.

**STOLON** - A trailing or reclining above ground stem capable of rooting and/or sending up new shoots from the nodes.

**STRUCTURAL** - Relating to something constructed or built by man.

**STRUCTURAL (SOIL)** - The combination or arrangement of primary soil particles into secondary particles, units or peds. (Dune sand is structureless)

**SUBCRITICAL FLOW** - Flow at velocities less than critical velocity.

**SUBGRADE** - The soil prepared and compacted to support a structure or a pavement system.

**TAILWATER (HYDRAULICS)** - Water, in a river or channel, immediately downstream from a structure.

**TEMPORARY SEEDING** - A seeding which is made to provide temporary cover for the soil while waiting for further construction or other activity to take place.

**TERRACE** - An embankment or combination of an embankment and channel constructed across a slope at a suitable spacing to control erosion by diverting or storing surface runoff instead of per ting it to flow uninterrupted down the slope. Normally used only on cropland.

**TEXTURE (SOIL)** - The relative proportions of various soil separates in a soil material.

**THATCH** - A tightly intermingled layer of living and dead stems, leaves and roots of grasses.

**TIME OF CONCENTRATION** - Time required for water to flow from the most remote point of a watershed, in a hydraulic sense, to the outlet.

**TOE (OF SLOPE)** - Where the slope stops or levels out. Bottom of the slope.

**TOE WALL** - Downstream wall of a structure, usually to prevent flowing water from eroding under the structure.

**TOPSOIL** - Fertile or desirable soil material used to top dress roadbanks, subsoils, parent material, etc.

**TRAP EFFICIENCY** - The capability of a reservoir to trap sediment. The ratio of sediment trapped to the sediment delivered, usually expressed in percent.

**TRASH RACK** - Grill, grate or other device at the intake of a channel, pipe, drain or spillway for the purpose of preventing oversize debris from entering the structure.

**UNHULLED (SEED)** - Seed still encased with a hull. Example: Sericea lespedeza before it is rendered hullless by mechanically removing the hull.

**UNIFIED SOIL CLASSIFICATION SYSTEM (ENGINEERING)** - A classification system based on the identification of soils according to their particle size, gradation, plasticity index and liquid limit.

**UNIFORM FLOW** - A state of steady flow when the mean velocity and cross-sectional area are equal at all sections of a reach.

**UNIVERSAL SOIL LOSS EQUATION** - An equation used for the design of water erosion control system:  $A=RKLSCP$  where A is average annual soil loss in tons per acre per year; R is rainfall factor; K is soil erodibility factor; L is length of slope; S is percent of slope; C is cropping and management factor; and P is conservation practice factor.

**UPLIFT (HYDRAULICS)** - The upward force of water on the base or underside of a structure.

VARIETY - A variant within a species which reproduces true by seed or vegetative propagation.

VELOCITY HEAD (HYDRAULICS) - Head due to the velocity of a moving fluid, equal to the square of the mean velocity divided by twice the acceleration due to gravity (32.16 feet per second per second).

WATER SURFACE PROFILE (HYDRAULICS) - The longitudinal profile assumed by the surface of a stream flowing in an open channel; the hydraulic grade line.

WEEP-HOLES (ENGINEERING) - Openings left in retaining walls, aprons, linings or foundations to permit drainage and reduce pressure.

WET STORAGE - The wet storage area is the 1800 cubic feet in the permanent pool of water in a sediment trap or basin.

WETTED PERIMETER (HYDRAULICS) - The length of the line of intersection of the plane or the hydraulic cross-section with the wetted surface of the channel

WING WALL - Side wall extensions of a structure used to prevent sloughing of banks or channels and to direct and confine overflow.

WOOD FIBER - A short fiber mulch material, usually applied with a hydro-seeder in an aqueous mixture.

From VA

APPENDIX B  
MISCELLANEOUS

## Appendix B

### Endangered species by stream

Applicants should notify the US Fish & Wildlife Service due to the presence or possible presence of endangered/threatened species when projects will discharge to the stream segments shown below:

- Kanawha River (Kanawha Falls to river mile 89.0 near Boomer) – Fayette County (Tubercled-blossom pearl mussel, *Epioblasma torulosa torulosa*; Pink mucket pearl mussel, *Lampsilis abrupta*; and Fanshell, *Cyprogenia stegaria*) (Virginia spiraea, *Spiraea virginiana*)
- Potts Creek – Monroe County (James spinymussel, *Pleurobema collina*)
- South Fork Potts Creek – Monroe County (James spinymussel, *Pleurobema collina*)
- Elk River – Braxton, Clay and Kanawha Counties (Pink mucket pearl mussel; *Lampsilis abrupta*; Northern riffleshell, *Epioblasma torulosa rangiana*; and Clubshell, *Pleurobema clava*)
- Meathouse Fork Middle Creek – Doddridge County (Clubshell, *Pleurobema clava*)
- Middle Island Creek – Doddridge, Tyler and Pleasants Counties (Clubshell, *Pleurobema clava*)
- Ohio River – Cabell, Mason and Wood Counties (Pink mucket pearl mussel, *Lampsilis abrupta*; and Fanshell, *Cyprogenia stegaria*)
- Gauley River – Nicholas and Fayette Counties (Virginia spiraea, *Spiraea virginiana*)
- Bluestone River – Mercer and Summers Counties (Virginia spiraea, *Spiraea virginiana*)
- Greenbrier River – Pocahontas and Greenbrier Counties (Virginia spiraea, *Spiraea virginiana*)
- Meadow River – Greenbrier and Fayette Counties (Virginia spiraea, *Spiraea virginiana*)
- Dingess Branch of Marsh Fork and associated palustrine emergent and scrub-shrub wetlands – Raleigh County (Virginia spiraea, *Spiraea virginiana*)
- Millers Camp Branch of Marsh Fork and associated palustrine emergent scrub-Shrub wetlands – Raleigh County (Virginia spiraea, *Spiraea virginiana*)
- South Fork Hughes River – Ritchie County (Clubshell, *Pleurobema clava*)
- Sleepy Creek – Morgan County (Harperella, *Ptilimnium nodosum*)
- Cacapon River – Morgan County (Harperella, *Ptilimnium nodosum*)
- Back Creek – Morgan County (Harperella, *Ptilimnium nodosum*)
- Hackers Creek of West Fork River – Lewis County (Clubshell, *Pleurobema clava*)
- Wetlands – Berkeley County (Northeastern bulrush, *Scirpus ancistrochaetu*)



## West Virginia MS4 Communities

### **WVR030011**

Village of Barboursville  
P.O. Box 266  
Barboursville, WV 25504-0266  
CABELL COUNTY

### **WVR030009**

City of Beckley/Beckley Sanitary Board  
P.O. Box 2494  
Beckley, WV 25802 – 2492  
RALEIGH COUNTY

### **WVR030015**

Town of Belle  
1100 East Dupont Avenue  
Belle, WV 25015 [waiver]  
KANAWHA COUNTY

### **WVR030026**

City of Benwood  
430 Main Street  
Benwood, WV 26031  
MARSHALL COUNTY

### **WVR030019**

Berkeley County Public Service Sewer District  
P.O. Box 944  
Martinsburg, WV 25402  
BERKELEY COUNTY

### **WVR030025**

Village of Bethlehem  
P.O. Box 6339  
Wheeling, WV 26003  
OHIO COUNTY

### **WVR030008**

City of Bluefield/Bluefield Sanitary Board  
P.O. Box 4100  
Bluefield, WV 24701  
MERCER COUNTY

### **WVR030014**

City of Ceredo  
P.O. Box 691  
Ceredo, WV 25507  
WAYNE COUNTY

### **WVR030006**

City of Charleston  
P.O. Box 2749  
Charleston, WV 25330-2749  
KANAWHA COUNTY

### **WVR030040**

Town of Chesapeake  
12404 MacCorkle Ave, SE  
Chesapeake, WV 25315 [waiver]  
KANAWHA COUNTY

### **WVR030034**

City of Clarksburg  
222 West Main Street  
Clarksburg, WV 26301  
HARRISON COUNTY

### **WVR030031**

City of Dunbar/Dunbar Sanitary Board  
P.O. Box 483  
Dunbar, WV 25064  
KANAWHA COUNTY

### **WVR030038**

City of Fairmont  
200 Jackson Street  
Fairmont, WV 26555-1428  
MARION COUNTY

### **WVR030045**

Fairmont State University  
1201 Locust Avenue  
Fairmont, WV 26554  
MARION COUNTY

### **WVR030012**

Federal Correctional Institution – Morgantown  
446 Greenbag Road  
Morgantown, WV 26507  
MONONGALIA COUNTY

**WVR030018**

City of Follansbee  
P.O. Box 606  
Follansbee, WV 26037 [waiver]  
BROOKE COUNTY

**WVR030024**

City of Glen Dale  
402 Wheeling Avenue  
Glen Dale, WV 26038 [waiver]  
MARSHALL COUNTY

**WVR030033**

City of Huntington  
P.O. Box 1659  
Huntington, WV 25717  
CABELL COUNTY

**WVR030010**

City of Hurricane/Storm Water Board  
P.O. Box 1086  
Hurricane, WV 25526  
PUTNAM COUNTY

**WVR030039**

City of Kenova  
P.O. Box 268  
Kenova, WV 25530  
WAYNE

**WVR030037**

City of Marmet  
P.O. Box 15037  
Marmet, WV 25315 [waiver]  
KANAWHA COUNTY

**WVR030043**

Marshall University  
One John Marshall Drive  
Huntington, WV 25755  
CABELL COUNTY

**WVR030017**

City of Martinsburg  
P.O. Box 828  
Martinsburg, WV 25401  
BERKELEY COUNTY

**WVR030036**

City of McMechen  
47 Ninth Street  
McMechen, WV 26040 [waiver]  
MARSHALL COUNTY

**WVR030003**

Town of Milton  
1139 Smith Street  
Milton, WV 25541  
CABELL COUNTY

**WVR030007**

City of Montgomery  
706 Third Avenue  
Montgomery, WV 25136 [waiver]  
FAYETTE COUNTY

**WVR030030**

Morgantown Utility Board  
P.O. Box 852  
Morgantown, WV 28507-0852  
MONONGALIA COUNTY

**WVR030013**

City of Moundsville/Moundsville Sanitary Board  
P.O. Box 480  
Moundsville, WV 26041  
MARSHALL COUNTY

**WVR030027**

City of Nitro  
20<sup>th</sup> Street & 2<sup>nd</sup> Avenue  
Nitro, WV 25143  
KANAWHA/PUTNAM COUNTY

**WVR030029**

City of Parkersburg  
One Government Square  
Parkersburg, WV 26102  
WOOD COUNTY

**WVR030035**

Town of Poca  
P.O. Box 586  
Poca, WV 25159 [waiver]  
PUTNAM

**WVR030005**

City of St. Albans  
1499 MacCorkle Avenue  
St. Albans, WV 25177  
KANAWHA COUNTY

**WVR030001**

City of South Charleston  
4<sup>th</sup> Avenue & D Street  
South Charleston, WV 25303  
KANAWHA COUNTY

**WVR030023**

Town of Star City  
370 Broadway Avenue  
Star City, WV 26505  
MONONGALIA COUNTY

**WVR030046**

Veterans Administration – Huntington Medical  
Center  
1540 Spring Valley Road  
Huntington, WV 25704  
WAYNE COUNTY

**WVR030047**

Veterans Administration – Martinsburg  
Medical Center  
510 Butler Avenue  
Martinsburg, WV 25413  
BERKELEY COUNTY

**WVR030032**

City of Vienna  
P.O. Box 5097  
Vienna, WV 26105  
WOOD COUNTY

**WVR030021**

City of Weirton  
200 Municipal Plaza  
Weirton, WV 26062  
HANCOCK COUNTY

**WVR030028**

City of Wellsburg  
70 Seventh Street  
Wellsburg, WV 26070 [waiver]  
BROOKE COUNTY

**WVR030022**

City of Westover  
500 Dupont Road  
Westover, WV 26505  
MONONGALIA COUNTY

**WVR030016**

City of Wheeling  
1500 Chapline Street  
Wheeling, WV 26003  
OHIO COUNTY

**WVR030020**

City of Williamstown  
100 West 5<sup>th</sup> Street  
Williamstown, WV 26187  
WOOD COUNTY

**WVR030004**

WV Department of Transportation  
1900 Kanawha Boulevard East  
Bldg. 5, Room A-125  
Charleston, WV 25305  
STATEWIDE COVERAGE

**WVR030041**

WV Turnpike Authority  
P.O. Box 1469  
Charleston, WV 25325-1469  
KANAWHA, RALEIGH & MERCER  
COUNTIES

**WVR030042**

West Virginia University  
P.O. Box 6551  
Morgantown, WV 26506  
MONONGALIA COUNTY

**WVR030044**

West Virginia *State* University  
P.O. Box 1000  
Institute, WV 25313  
KANAWHA COUNTY

APPENDIX C  
REFERENCES

## APPENDIX C

### REFERENCES

- Applied Polymer Systems, Inc. Floc Log. Available at: <http://www.siltstop.com/>.
- Austin, Texas. Environmental Criteria Manual. City of Austin, Texas..
- Bidelspach and Jarrett, [Delayed Dewatering of Sediment Basins Improves Water Quality](#). Penn State University
- California Stormwater Quality Association (CASQA).. California Stormwater BMP Handbook - Construction. [www.cabmphandbooks.com](http://www.cabmphandbooks.com) 2003
- Caltrans. Storm Water Quality Handbooks, Construction Site Best Management Practices Manual. 2003
- Center for Watershed Protection, The Practice of Watershed Protection - Watershed Protection Techniques. 2000
- Center for Watershed Protection. [Construction Standards/Specifications for Ponds](#).
- Connecticut Department of Transportation, Storm Drainage Systems. [2000 Drainage Manual](#)
- Dane County Wisconsin, Office of Lake and Watersheds. [Dane County Erosion Control and Stormwater Management Manual](#). 2004
- Douglas County Colorado. Department of Public Works. [Grading, Erosion and Sediment Control Manual](#). 2004
- Erosion Control Technology Council (ECTC).. [Erosion Control Technology Council Guidance](#). 2006
- Faircloth and Son. Faircloth Skimmer. [A Manual for Designing, Installing, and Maintaining Skimmer Sediment Basins](#). 2005
- Federal Energy Regulatory Commission, Office of Pipeline Regulation. [Upland Erosion Control, Revegetation, and Maintenance Plan](#). Washington, D.C. 1994.
- Federal Energy Regulatory Commission, Office of Pipeline Regulation. [Wetland and Waterbody Construction and Mitigation Procedures](#). Washington, D.C. December 2, 1994.
- Georgia Environmental Protection Division. [Erosion and Sediment Control Manual](#). 2000
- Illinois Environmental Protection Agency. [1995 Illinois Urban Manual](#). Illinois EPA, Division of Water Pollution Control. Prepared by USDA, NRCS, Champaign, Illinois. 1995.
- Indian Department of Environmental Protection. [Indiana Handbook for Erosion Control](#)

Indian Department of Environmental Protection. [Erosion & Sediment Control for Individual Building Sites](#).

Iowa Department of Natural Resources. [Iowa Construction Site Erosion Control Manual](#).

Iowa State University/Iowa Statewide Urban Design and Specifications. [Iowa Statewide Urban Design Standards Manual](#). 2005

King County, Washington, King County, Department of Natural Resources and Parks, [Surface Water Design Manual](#), 2004.

Knoxville Tennessee, Stormwater Engineering Division, [Best Management Practice Manual](#), 2003.

Maine Department of Environmental Protection, [Maine Erosion and Sediment Control BMP Manual](#). 2005

Maine Forest Service, [Best Management Practices for Forestry: Protecting Water Quality](#). 2003.

Maryland Department of the Environment,. [Maryland Standards and Specifications for Soil Erosion and Sediment Control](#). 1991

Maryland Department of the Environment, 2000. [Maryland Stormwater Design Manual](#).

Massachusetts Department of Fish and Game. [Stream Crossings Handbook](#). 2005

Massachusetts Department of Environmental Protection. [Nonpoint Source Management Manual](#). 1994.

McLaughlin, Richard, "[SoilFacts: Baffles to Improve Sediment Basins](#)." N. C State University Cooperative Extension Service. 2005

McLaughlin R. A.. [Using Baffles to Improve Sediment Basins](#). N. C State University Cooperative Extension Service. 2005

Michigan Department of Environmental Quality. [Guidebook of Best Management Practices for Michigan Watersheds](#). 1998

Michigan Department of Environmental Quality. [Soil Erosion and Sediment Control Training Manual](#). 2005

New York State Department of Environmental Conservation, Division of Water. [New York Standards and Specifications for Erosion and Sediment Control](#). 2004.

Nilex. GeoRidge Specifications, <http://www.nilex.com/Products.aspx?ProductID=23>

North American Green. Products & Design Software. Available at: <http://www.nagreen.com..>

North Carolina Department of Environment and Natural Resources. [Division of Land Resources. Erosion and Sediment Control Planning and Design Manual](#). 1988 and 2006 Draft.

Oregon Department of Environmental Quality. [Erosion and Sediment Control Manual](#), 2005

Pennsylvania Department of Environmental Protection. [Erosion and Sediment Pollution Control Program Manual](#). 2000

Profile Products [Terra-Tubes Brochure](#)

Reid, Scott M. and Anderson, Paul G..Alliance-Pipeline. [Effects of Sediment Released During Open-cut Pipeline Water Crossings](#).

South Carolina Department of Health and Environmental Control, [Storm Water Management and Sediment Control Handbook for Land Disturbing Activities](#). 2005

Southeast Pennsylvania Association of Conservation Districts. [Erosion and Sedimentation Pollution Control Plan Guide for Small Projects](#). 1995.

Sullivan, Brian. City of High Point Erosion Control Specifications. 2005

Tacoma Washington, [Surface Water Management Manual](#). 2003

Tennessee Department of Environment and Conservation, [Tennessee Erosion and Sediment Control Handbook](#). 2002.

U.S. Army Corps of Engineers. Engineering and Design – [Handbook for the Preparation of Storm Water Pollution Prevention Plans for Construction Activities](#). 1997

U.S. Department of Agriculture, Forest Service. [A Landowners Guide to Building Forest Access Roads](#)., Radnor, PA 1998

U.S. Department of Agriculture - Natural Resources Conservation Service. [Field Office Technical Guide](#). Champaign, IL

U.S. Department of Agriculture - Natural Resources Conservation Service. [Engineering Field Handbook](#). Washington D.C.

U.S. Department of Agriculture - Natural Resources Conservation Service. [National Engineering Handbook](#), Washington D.C.

U.S. Department of Agriculture. Urban Hydrology for Small Watersheds. [Technical Release 55 \(TR-55\)](#). National Technical Information Service. 1986. 2005.

U.S. Department of Transportation, Federal Highway Administration. Design of Stable Channels with Flexible Linings, HEC-15. NTIS PB89-122584/AS. 1975.

U.S. Department of Transportation, Federal Highway Administration. Hydraulic Charts for the Selection of Highway Culverts, HEC-5. 1965.

U.S. Department of Transportation, Federal Highway Administration. Design of Energy Dissipators for Culverts and Channels, HEC-14. NTIS PB86-180205/AS. 1983.

U.S. Department of Transportation, Federal Highway Administration. Capacity Charts for the Hydraulic Design of Highway Culverts, HEC-10. 1972.

U.S. Department of Transportation, Federal Highway Administration. Hydraulic Riprap for Bank Protection, HEC-11. 1967.

Vermont Department of Environmental Quality. [Vermont Standards and Specifications for Erosion Prevention and Sediment Control](#). 2006 Draft

Virginia Department of Conservation and Recreation. Division of Soil and Water Conservation. [Virginia Soil and Erosion Control Handbook](#), Third Edition. 1992

Virginia Department of Forestry. [Virginia's Forestry Best Management Practices for Water Quality](#). 2002.

Washington Department of Ecology, WA. [Stormwater Management Manual for Western Washington](#). 2005

West Virginia Division of Highways. [Standard Specifications for Roads and Bridges](#), 2000 and 2003 Supplement.

West Virginia Division of Highways. [Erosion and Sediment Control Handbook](#), 2003 and 2004 Addendum 1.

Wisconsin Department of Natural Resources. [Construction Site Erosion and Sediment Control](#).

Zwim, Michael. Wild Salmon Center. [Pipeline-Stream Crossing: Best Management Practices](#). 2002.

**EPA has a page that lists numerous Storm Water Management Manuals, some which cover sediment control, at this address**

<http://yosemite.epa.gov/R10/WATER.NSF/0/17090627a929f2a488256bdc007d8dee?OpenDocument>

Links change over time; if you find a broken link please notify the Stormwater Program.



# APPENDIX D

## **West Virginia High Slip Potential Soils by County**

<b>BARBOUR</b>		
<b>Name</b>	<b>Symbol</b>	<b>Soil Slip Potential</b>
Belmont and Cateache gravelly silt loams, 20 to 35 percent slopes, very stony	BcE	HIGH
Belmont and Cateache gravelly silt loams, 35 to 65 percent slopes, very stony	BcF	HIGH
Bethesda channery silt loam, 15 to 35 percent slopes	BeE	HIGH
Bethesda-Rock outcrop complex, very steep, very stony	BoF	HIGH
Clarksburg silt loam, 15 to 25 percent slopes	CID	HIGH
Dekalb channery loam, 25 to 35 percent slopes	DaE	HIGH
Dekalb channery loam, 35 to 65 percent slopes	DaF	HIGH
Dekalb channery loam, 15 to 35 percent slopes, very stony	DbE	HIGH
Dekalb channery loam, 35 to 65 percent slopes, very stony	DbF	HIGH
Ernest silt loam, 15 to 25 percent slopes	EnD	HIGH
Ernest silt loam, 3 to 20 percent slopes, extremely stony	ErC	HIGH
Gilpin channery silt loam, 25 to 35 percent slopes	GcE	HIGH
Gilpin channery silt loam, 25 to 35 percent slopes, severely eroded	GcE3	HIGH
Gilpin channery silt loam, 35 to 65 percent slopes	GcF	HIGH
Gilpin-Dekalb complex, 15 to 35 percent slopes, very stony	GdE	HIGH
Gilpin-Dekalb complex, 35 to 65 percent slopes, very stony	GdF	HIGH
Gilpin-Upshur complex, 15 to 25 percent slopes	GuD	HIGH
Gilpin-Upshur complex, 15 to 25 percent slopes, severely eroded	GuD3	HIGH
Gilpin-Upshur complex, 25 to 35 percent slopes	GuE	HIGH
Gilpin-Upshur complex, 25 to 35 percent slopes, severely eroded	GuE3	HIGH
Gilpin-Upshur complex, 35 to 70 percent slopes	GuF	HIGH
Itmann channery clay loam, very steep	ItF	HIGH
Janelew channery silt loam, 15 to 35 percent slopes	JnE	HIGH
Janelew-Rock outcrop complex, very steep, very stony	JoF	HIGH
Westmoreland silt loam, 25 to 35 percent slopes	WmE	HIGH
Westmoreland silt loam, 25 to 35 percent slopes, severely eroded	WmE3	HIGH
Westmoreland silt loam, 35 to 60 percent slopes	WmF	HIGH
Westmoreland silt loam, 35 to 60 percent slopes	WmF3	HIGH

<b>BRAXTON</b>		
<b>Name</b>	<b>Symbol</b>	<b>Soil Slip Potential</b>
Vandalia silt loam, 25 to 35 percent slopes	VaE	HIGH
Vandalia silt loam, 15 to 35 percent slopes, very stony	VxE	HIGH

<b>BROOKE</b>		
<b>Name</b>	<b>Symbol</b>	<b>Soil Slip Potential</b>
Berks channery silt loam, 25 to 35 percent slopes, severely eroded	BeE3	High
Berks soils, 35 to 65 percent slopes	BkF	High
Brooke silty clay loam, 15 to 25 percent slopes	BoD	High
Brookside silt loam, 15 to 25 percent slopes	BrD	High
Clarksburg silt loam, 15 to 25 percent slopes	CkD	High
Guernsey silt loam, 8 to 15 percent slopes	GuC	High
Guernsey silt loam, 15 to 25 percent slopes	GuD	High
Guernsey silt loam, 15 to 25 percent slopes, severely eroded	GuD3	High
Westmoreland silt loam, 25 to 35 percent slopes	WeE	High
Westmoreland silt loam, 35 to 60 percent slopes	WeF	High

<b>CABELL</b>		
<b>Name</b>	<b>Symbol</b>	<b>Soil Slip Potential</b>
Gilpin silt loam, 25 to 35 percent slopes	GIE	HIGH
Gilpin-Upshur complex, 15 to 25 percent slopes	GuD	HIGH
Gilpin-Upshur complex, 25 to 35 percent slopes	GuE	HIGH
Gilpin-Upshur complex, 35 to 70 percent slopes	GuF	HIGH
Vandalia silt loam, 15 to 25 percent slopes	VaD	HIGH

<b>CALHOUN</b>		
<b>Name</b>	<b>Symbol</b>	<b>Soil Slip Potential</b>
Vandalia silt loam, 15 to 25 percent slopes	VaD	HIGH

<b>CLAY</b>		
<b>Name</b>	<b>Symbol</b>	<b>Soil Slip Potential</b>
Cedarcreek very channery loam, very steep, very stony	CeF	HIGH
Fairpoint channery loam, very steep, very stony	FpF	HIGH
Gilpin-Upshur silt loams, 15 to 25 percent slopes	GuD	HIGH
Gilpin-Upshur silt loams, 25 to 35 percent slopes	GuE	HIGH
Gilpin-Upshur complex, 35 to 70 percent slopes, very stony	GxF	HIGH
Itmann channery clay loam, very steep	ItF	HIGH
Vandalia silt loam, 15 to 25 percent slopes	VaD	HIGH
Vandalia silt loam, 25 to 35 percent slopes	VaE	HIGH

<b>DODDRIDGE</b>		
<b>Name</b>	<b>Symbol</b>	<b>Soil Slip Potential</b>
Gilpin-Upshur silt loams, 15 to 25 percent slopes	GuD	HIGH
Gilpin-Peabody complex, 25 to 35 percent slopes	GpE	HIGH
Gilpin-Peabody complex, 15 to 35 percent slopes, very stony	GsE	HIGH
Gilpin-Peabody complex, 35 to 70 percent slopes, very stony	GsF	HIGH
Gilpin-Upshur-Urban land complex, 15 to 25 percent slopes	GyD	HIGH
Vandalia silt loam, 15 to 25 percent slopes	VaD	HIGH
Vandalia silt loam, 25 to 35 percent slopes	VaE	HIGH
Vandalia silt loam, 15 to 35 percent slopes, very stony	VsE	HIGH
Vandalia-Urban land complex, 15 to 25 percent slopes	VuD	HIGH

<b>FAYETTE</b>		
<b>Name</b>	<b>Symbol</b>	<b>Soil Slip Potential</b>
Berks-Highsplint-Sharondale complex, 35 to 80 percent slopes, very stony	BhG	High
Cateache-Pipestem complex, 35 to 80 percent slopes, very stony	CcG	High
Gilpin-Highsplint-Berks complex, 35 to 90 percent slopes, extremely stony	GhG	High
Layland-Clifftop complex, 35 to 70 percent slopes, very stony	LdF	High
Layland-Dekalb-Guyandotte complex, 35 to 70 percent slopes, extremely stony	LeF	High
Layland-Dekalb-Rock outcrop complex, 55 to 80 percent slopes, extremely stony	LgG	High

Name	Symbol	Soil Slip Potential
Layland-Rock outcrop complex, 35 to 70 percent slopes, very rubbly	LkF	High
Lithic Udorthents-Rock outcrop complex, cut land, 5 to 100 percent slopes	LxG	High
Udorthents, graded, 15 to 55 percent slopes	UgF	High

GILMER		
Name	Symbol	Soil Slip Potential
Vandalia silt loam, 15 to 25 percent slopes	VaD	High
Vandalia silt loam, 15 to 35 percent slopes, very stony	VsE	High

HARRISON		
Name	Symbol	Soil Slip Potential
Clarksburg silt loam, 15 to 25 percent slopes	CID	HIGH
Clarksburg silt loam, 15 to 25 percent slopes, severely eroded	CID3	HIGH
Culleoka silt loam, 25 to 35 percent slopes	CuE	HIGH
Culleoka silt loam, 25 to 35 percent slopes, severely eroded	CuE3	HIGH
Culleoka silt loam, 35 to 60 percent slopes, severely eroded	CuF3	HIGH
Dekalb extremely stony sandy loam, very steep	DSF	HIGH
Ernest silt loam, 15 to 25 percent slopes	EnD	HIGH
Ernest very stony silt loam, 15 to 35 percent slopes	EsD	HIGH
Faywood silty clay loam, 15 to 25 percent slopes	FaD	HIGH
Faywood silty clay loam, 25 to 35 percent slopes	FaE	HIGH
Faywood silty clay loam, 35 to 60 percent slopes	FaF	HIGH
Gilpin silt loam, 25 to 35 percent slopes	GIE	HIGH
Gilpin silt loam, 35 to 70 percent slopes	GIF	HIGH
Gilpin very stony silt loam, 15 to 35 percent slopes	GsE	HIGH
Gilpin very stony silt loam, very steep	GTF	HIGH
Gilpin-Upshur complex, 15 to 25 percent slopes	GuD	HIGH
Gilpin-Upshur complex, 15 to 25 percent slopes, severely eroded	GuD3	HIGH
Gilpin-Upshur complex, 25 to 35 percent slopes	GuE	HIGH
Gilpin-Upshur complex, 25 to 35 percent slopes, severely eroded	GuE3	HIGH
Gilpin-Upshur complex, 35 to 70 percent slopes, severely eroded	GuF3	HIGH
Guernsey silt loam, 8 to 15 percent slopes	GyC	HIGH

<b>Name</b>	<b>Symbol</b>	<b>Soil Slip Potential</b>
Guernsey silt loam, 15 to 25 percent slopes	GyD	HIGH
Guernsey silt loam, 15 to 25 percent slopes, severely eroded	GyD3	HIGH
Upshur silty clay, 15 to 25 percent slopes, severely eroded	UhD3	HIGH
Vandalia silty clay loam, 15 to 25 percent slopes	VaD	HIGH
Vandalia silty clay loam, 15 to 25 percent slopes, severely eroded	VaD3	HIGH
Westmoreland silt loam, 25 to 35 percent slopes	WmE	HIGH
Westmoreland silt loam, 25 to 35 percent slopes, severely eroded	WmE3	HIGH
Westmoreland silt loam, 35 to 60 percent slopes	WmF	HIGH

<b>HANCOCK</b>		
<b>Name</b>	<b>Symbol</b>	<b>Soil Slip Potential</b>
Berks channery silt loam, 25 to 35 percent slopes, severely eroded	BeE3	High
Berks soils, 35 to 65 percent slopes	BkF	High
Brooke silty clay loam, 15 to 25 percent slopes	BoD	High
Brookside silt loam, 15 to 25 percent slopes	BrD	High
Clarksburg silt loam, 15 to 25 percent slopes	CkD	High
Guernsey silt loam, 8 to 15 percent slopes	GuC	High
Guernsey silt loam, 15 to 25 percent slopes	GuD	High
Guernsey silt loam, 15 to 25 percent slopes, severely eroded	GuD3	High
Westmoreland silt loam, 25 to 35 percent slopes	WeE	High
Westmoreland silt loam, 35 to 60 percent slopes	WeF	High

<b>JACKSON</b>		
<b>Name</b>	<b>Symbol</b>	<b>Soil Slip Potential</b>
Culleoka-Lowell complex, 25 to 35 percent slopes	CuE	High
Gilpin-Peabody complex, 35 to 65 percent slopes, severely eroded	GIF3	High
Gilpin-Peabody complex, 35 to 65 percent slopes, very stony	GmF	High
Gilpin-Peabody-Rock outcrop complex, 35 to 65 percent slopes, very stony	GoF	High
Gilpin-Upshur silt loams, 15 to 25 percent slopes	GpD	High
Gilpin-Upshur complex, 15 to 25 percent slopes, severely eroded	GpD3	High

Name	Symbol	Soil Slip Potential
Gilpin-Upshur silt loams, 25 to 35 percent slopes	GpE	High
Gilpin-Upshur complex, 25 to 35 percent slopes, severely eroded	GpE3	High
Peabody-Gilpin complex, 35 to 65 percent slopes	PgF	High
Peabody-Gilpin complex, 35 to 65 percent slopes, severely eroded	PgF3	High
Upshur silt loam, 15 to 25 percent slopes	UeD	High
Upshur-Gilpin complex, 15 to 25 percent slopes	UgD	High
Upshur-Gilpin complex, 15 to 25 percent slopes, severely eroded	UgD3	High
Upshur-Gilpin complex, 25 to 35 percent slopes	UgE	High
Upshur-Gilpin complex, 25 to 35 percent slopes, severely eroded	UgE3	High
Vandalia silt loam, 15 to 25 percent slopes	VdD	High
Vandalia silt loam, 25 to 35 percent slopes	VdE	High
Vandalia silty clay loam, 15 to 25 percent slopes, severely eroded	VsD3	High
Vandalia silty clay loam, 25 to 35 percent slopes, severely eroded	VsE3	High
Vandalia silt loam, 15 to 35 percent slopes, very stony	VtE	High
Vandalia silt loam, 15 to 35 percent slopes, bouldery	VxE	High

<b>MASON</b>		
Name	Symbol	Soil Slip Potential
Culleoka-Lowell complex, 25 to 35 percent slopes	CuE	High
Gilpin-Peabody complex, 35 to 65 percent slopes, severely eroded	GIF3	High
Gilpin-Peabody complex, 35 to 65 percent slopes, very stony	GmF	High
Gilpin-Peabody-Rock outcrop complex, 35 to 65 percent slopes, very stony	GoF	High
Gilpin-Upshur silt loams, 15 to 25 percent slopes	GpD	High
Gilpin-Upshur complex, 15 to 25 percent slopes, severely eroded	GpD3	High
Gilpin-Upshur silt loams, 25 to 35 percent slopes	GpE	High
Gilpin-Upshur complex, 25 to 35 percent slopes, severely eroded	GpE3	High
Peabody-Gilpin complex, 35 to 65 percent slopes	PgF	High
Peabody-Gilpin complex, 35 to 65 percent slopes, severely eroded	PgF3	High
Upshur silt loam, 15 to 25 percent slopes	UeD	High
Upshur-Gilpin complex, 15 to 25 percent slopes	UgD	High

<b>Name</b>	<b>Symbol</b>	<b>Soil Slip Potential</b>
Upshur-Gilpin complex, 15 to 25 percent slopes, severely eroded	UgD3	High
Upshur-Gilpin complex, 25 to 35 percent slopes	UgE	High
Upshur-Gilpin complex, 25 to 35 percent slopes, severely eroded	UgE3	High
Vandalia silt loam, 15 to 25 percent slopes	VdD	High
Vandalia silt loam, 25 to 35 percent slopes	VdE	High
Vandalia silty clay loam, 15 to 25 percent slopes, severely eroded	VsD3	High
Vandalia silty clay loam, 25 to 35 percent slopes, severely eroded	VsE3	High
Vandalia silt loam, 15 to 35 percent slopes, very stony	VtE	High
Vandalia silt loam, 15 to 35 percent slopes, bouldery	VxE	High

<b>JEFFERSON</b>		
<b>Name</b>	<b>Symbol</b>	<b>Soil Slip Potential</b>
Bagtown very flaggy sandy loam, 25 to 45 percent slopes, extremely stony	BgE	High
Bagtown very flaggy loam, 25 to 65 percent slopes, rubbly	BnF	High
Bagtown-Stumptown-Rock outcrop complex, 25 to 65 percent slopes	BoF	High
Hagerstown-Opequon-Rock outcrop complex, 15 to 35 percent slopes	HgE	High
Rock outcrop-Opequon complex, 25 to 60 percent slopes	ReF	High
Weverton-Rock outcrop complex, 15 to 45 percent slopes, very stony	WoE	High
Bagtown very flaggy sandy loam, 25 to 45 percent slopes, extremely stony	BgE	High

<b>KANAWHA</b>		
<b>Name</b>	<b>Symbol</b>	<b>Soil Slip Potential</b>
Vandalia silt loam, 15 to 25 percent slopes	VaD	High
Vandalia silt loam, 25 to 35 percent slopes	VaE	High
Vandalia silty clay loam, 15 to 25 percent slopes, severely eroded	VdD3	High



<b>LEWIS</b>		
<b>Name</b>	<b>Symbol</b>	<b>Soil Slip Potential</b>
Bethesda-Rock outcrop complex, steep, very stony	BrE	High
Gilpin silt loam, 25 to 35 percent slopes	GaE	High
Gilpin silt loam, 35 to 70 percent slopes	GaF	High
Gilpin-Dekalb association, very steep, very stony	GDF	High
Gilpin-Upshur silt loams, 15 to 25 percent slopes	GuD	High
Gilpin-Upshur silt loams, 25 to 35 percent slopes	GuE	High
Gilpin-Upshur silt loams, 35 to 70 percent slopes, severely eroded	GwF3	High
Janelew channery silt loam, steep	JaE	High
Vandalia silt loam, 15 to 25 percent slopes	VaD	High
Vandalia silt loam, 25 to 35 percent slopes	VaE	High
Westmoreland-Upshur complex, 25 to 35 percent slopes, severely eroded	WuE3	High

<b>LINCOLN</b>		
<b>Name</b>	<b>Symbol</b>	<b>Soil Slip Potential</b>
Beech loam, 15 to 25 percent slopes	BeD	High
Beech loam, 25 to 35 percent slopes	BeE	High
Gilpin silt loam, 25 to 35 percent slopes	GiE	High
Gilpin-Upshur silt loams, 15 to 25 percent slopes	GpD	High
Gilpin-Upshur silt loams, 25 to 35 percent slopes	GpE	High
Gilpin-Upshur silt loams, 35 to 70 percent slopes	GpF	High

<b>MARSHALL</b>		
<b>Name</b>	<b>Symbol</b>	<b>Soil Slip Potential</b>
Brookside silt loam, 15 to 25 percent slopes	BrD	High
Brookside silt loam, 25 to 35 percent slopes	BrE	High
Culleoka-Dormont-Peabody complex, 15 to 25 percent slopes	CpD	High
Culleoka-Dormont-Peabody complex, 25 to 35 percent slopes	CpE	High
Culleoka-Dormont-Peabody complex, 35 to 65 percent slopes, very stony	CrF	High
Culleoka-Peabody complex, 15 to 25 percent slopes	CyD	High
Dormont silt loam, 25 to 35 percent slopes	DoE	High
Dormont-Culleoka complex, 25 to 35 percent slopes	DrE	High
Dormont-Culleoka complex, 35 to 70 percent slopes, very stony	DsF	High

Name	Symbol	Soil Slip Potential
Gilpin-Dormont silt loams, 35 to 70 percent slopes, very stony	GdF	High
Guernsey silt loam, 15 to 25 percent slopes	GuD	High
Guernsey silt loam, 8 to 15 percent slopes	GuC	High
Urban land-Brookside complex, 15 to 25 percent slopes	UmD	High

<b>MARION</b>		
Name	Symbol	Soil Slip Potential
Buchanan and Ernest very stony soils, 15 to 25 percent slopes	BeD	High
Clarksburg silt loam, 15 to 25 percent slopes	CkD	High
Culleoka-Westmoreland silt loams, 25 to 35 percent slopes	CwE	High
Culleoka-Westmoreland silt loams, 35 to 65 percent slopes	CwF	High
Dekalb channery loam, 25 to 35 percent slopes	DaE	High
Dekalb very stony loam, 15 to 35 percent slopes	DdE	High
Dekalb very stony loam, 35 to 65 percent slopes	DdF	High
Dormont and Guernsey silt loams, 8 to 15 percent slopes	DgC	High
Dormont and Guernsey silt loams, 15 to 25 percent slopes	DgD	High
Ernest silt loam, 15 to 25 percent slopes	ErD	High
Gilpin silt loam, 25 to 35 percent slopes	GaE	High
Gilpin silt loam, 35 to 65 percent slopes	GaF	High
Gilpin-Culleoka silt loams, 25 to 35 percent slopes	GcE	High
Gilpin-Culleoka silt loams, 35 to 65 percent slopes	GcF	High
Gilpin-Culleoka-Upshur silt loams, 15 to 25 percent slopes	GuD	High
Gilpin-Culleoka-Upshur silt loams, 25 to 35 percent slopes	GuE	High
Gilpin-Culleoka-Upshur silt loams, 35 to 65 percent slopes	GuF	High
Gilpin-Culleoka-Upshur complex, 15 to 25 percent slopes, severely eroded	GwD3	High
Gilpin-Culleoka-Upshur complex, 25 to 35 percent slopes, severely eroded	GwE3	High
Upshur-Belmont very stony silt loams, 35 to 65 percent slopes	UbF	High
Westmoreland silt loam, 25 to 35 percent slopes	WeE	High
Westmoreland silt loam, 35 to 60 percent slopes	WeF	High

<b>MONONGALIA</b>		
<b>Name</b>	<b>Symbol</b>	<b>Soil Slip Potential</b>
Buchanan and Ernest very stony soils, 15 to 25 percent slopes	BeD	High
Clarksburg silt loam, 15 to 25 percent slopes	CkD	High
Culleoka-Westmoreland silt loams, 25 to 35 percent slopes	CwE	High
Culleoka-Westmoreland silt loams, 35 to 65 percent slopes	CwF	High
Dekalb channery loam, 25 to 35 percent slopes	DaE	High
Dekalb very stony loam, 15 to 35 percent slopes	DdE	High
Dekalb very stony loam, 35 to 65 percent slopes	DdF	High
Dormont and Guernsey silt loams, 8 to 15 percent slopes	DgC	High
Dormont and Guernsey silt loams, 15 to 25 percent slopes	DgD	High
Ernest silt loam, 15 to 25 percent slopes	ErD	High
Gilpin silt loam, 25 to 35 percent slopes	GaE	High
Gilpin silt loam, 35 to 65 percent slopes	GaF	High
Gilpin-Culleoka silt loams, 25 to 35 percent slopes	GcE	High
Gilpin-Culleoka silt loams, 35 to 65 percent slopes	GcF	High
Gilpin-Culleoka-Upshur silt loams, 15 to 25 percent slopes	GuD	High
Gilpin-Culleoka-Upshur silt loams, 25 to 35 percent slopes	GuE	High
Gilpin-Culleoka-Upshur silt loams, 35 to 65 percent slopes	GuF	High
Gilpin-Culleoka-Upshur complex, 15 to 25 percent slopes, severely eroded	GwD3	High
Gilpin-Culleoka-Upshur complex, 25 to 35 percent slopes, severely eroded	GwE3	High
Upshur-Belmont very stony silt loams, 35 to 65 percent slopes	UbF	High
Westmoreland silt loam, 25 to 35 percent slopes	WeE	High
Westmoreland silt loam, 35 to 60 percent slopes	WeF	High

<b>MORGAN</b>		
<b>Name</b>	<b>Symbol</b>	<b>Soil Slip Potential</b>
Blackthorn very gravelly sandy loam, 35 to 55 percent slopes, rubbly	BqF	High
Buchanan loam, 15 to 35 percent slopes, extremely stony	BxE	High

Name	Symbol	Soil Slip Potential
Caneyville silt loam, 8 to 15 percent slopes	CIC	High
Caneyville silt loam, 15 to 25 percent slopes	CID	High
Caneyville silt loam, 25 to 35 percent slopes	CIE	High
Caneyville silty clay loam, 35 to 65 percent slopes	CnF	High
Hazleton-Dekalb complex, 15 to 35 percent slopes, extremely stony	HaE	High
Hazleton-Dekalb complex, 35 to 65 percent slopes, extremely stony	HaF	High
Hazleton-Dekalb-Rock outcrop complex, 35 to 65 percent slopes, rubbly	HdF	High
Hazleton-Dekalb-Rock outcrop complex, 35 to 65 percent slopes, very rubbly	HeF	High
Hazleton-Lehew-Dekalb complex, 35 to 65 percent slopes, extremely stony	HIF	High
Murrill gravelly loam, 15 to 25 percent slopes	MrD	High
Murrill loam, 15 to 35 percent slopes, extremely stony	MsE	High
Rock outcrop-Opequon complex, 55 to 100 percent slopes	ReG	High
Rock outcrop-Rough complex, 55 to 100 percent slopes	RgG	High
Rushtown channery silt loam, 35 to 65 percent slopes	RuF	High
Schaffemaker-Vanderlip loamy sands, 15 to 35 percent slopes, very bouldery	SnE	High
Schaffemaker-Vanderlip loamy sands, 35 to 65 percent slopes, very bouldery	SnF	High
Sideling gravelly loam, 15 to 35 percent slopes, extremely stony	SxE	High
Sideling gravelly loam, 15 to 35 percent slopes, rubbly	SyE	High

<b>NICHOLAS</b>		
Name	Symbol	Soil Slip Potential
Clifftop channery silt loam, 35 to 70 percent slopes, very stony	CnF	High
Clifftop-Buchanan complex, 35 to 70 percent slopes, extremely stony	CoF	High
Clifftop-Dekalb complex, 15 to 35 percent slopes, extremely stony	CpE	High
Gilpin silt loam, 35 to 70 percent slopes	GIF	High
Layland-Clifftop complex, 35 to 70 percent slopes, very stony	LdF	High
Pineville-Clifftop complex, 55 to 70 percent slopes, extremely stony	PfG	High

Name	Symbol	Soil Slip Potential
Berks-Highsplint-Sharondale complex, 35 to 80 percent slopes, very stony	BhG	High
Highsplint channery loam, 15 to 35 percent slopes, very stony	HgE	High
Laidig-Clifftop complex, 15 to 35 percent slopes, very stony	LcE	High
Layland-Laidig complex, 15 to 35 percent slopes, rubbly	LhE	High
Layland-Laidig complex, 15 to 35 percent slopes, very rubbly	LkE	High
Layland-Rock outcrop complex, 35 to 70 percent slopes, very rubbly	LmF	High
Lithic Udorthents-Rock outcrop complex, cut land, 5 to 100 percent slopes	LxG	High
Udorthents, graded, 15 to 55 percent slopes	UgF	High

OHIO		
Name	Symbol	Soil Slip Potential
Berks channery silt loam, 25 to 35 percent slopes, severely eroded	BeE3	High
Berks soils, 35 to 65 percent slopes	BkF	High
Brooke silty clay loam, 15 to 25 percent slopes	BoD	High
Brookside silt loam, 15 to 25 percent slopes	BrD	High
Clarksburg silt loam, 15 to 25 percent slopes	CkD	High
Guernsey silt loam, 8 to 15 percent slopes	GuC	High
Guernsey silt loam, 15 to 25 percent slopes	GuD	High
Guernsey silt loam, 15 to 25 percent slopes, severely eroded	GuD3	High
Westmoreland silt loam, 25 to 35 percent slopes	WeE	High
Westmoreland silt loam, 35 to 60 percent slopes	WeF	High

PLEASANTS		
Name	Symbol	Soil Slip Potential
Cedarcreek channery silt loam, steep, stony	CeE	High
Gilpin-Upshur complex, 15 to 25 percent slopes	GpD	High
Gilpin-Upshur complex, 25 to 35 percent slopes	GpE	High
Gilpin-Upshur complex, 35 to 70 percent slopes	GpF	High
Gilpin-Upshur complex, 15 to 25 percent slopes, severely eroded	GwD3	High

Name	Symbol	Soil Slip Potential
Gilpin-Upshur complex, 25 to 35 percent slopes, severely eroded	GwE3	High
Gilpin-Upshur-Rock outcrop complex, 35 to 70 percent slopes	GxF	High
Vandalia silt loam, 15 to 25 percent slopes	VaD	High
Vandalia silt loam, 15 to 25 percent slopes, very stony	VbD	High

PUTNAM		
Name	Symbol	Soil Slip Potential
Gilpin-Upshur complex, 15 to 25 percent slopes	GuD	High
Gilpin-Upshur complex, 25 to 35 percent slopes	GuE	High
Gilpin-Upshur complex, 35 to 70 percent slopes	GuF	High
Vandalia silt loam, 15 to 25 percent slopes	VaD	High
Vandalia silt loam, 25 to 35 percent slopes	VaE	High
Vandalia silty clay loam, 15 to 25 percent slopes, severely eroded	VdD3	High

Raleigh		
Name	Symbol	Soil Slip Potential
Berks-Highsplint-Sharondale complex, 35 to 80 percent slopes, very stony	BhG	High
Cateache-Pipestem complex, 35 to 80 percent slopes, very stony	CcG	High
Gilpin-Highsplint-Berks complex, 35 to 90 percent slopes, extremely stony	GhG	High
Layland-Cliff-top complex, 35 to 70 percent slopes, very stony	LdF	High
Layland-Dekalb-Guyandotte complex, 35 to 70 percent slopes, extremely stony	LeF	High
Layland-Dekalb-Rock outcrop complex, 55 to 80 percent slopes, extremely stony	LgG	High
Layland-Rock outcrop complex, 35 to 70 percent slopes, very rubbly	LkF	High
Lithic Udorthents-Rock outcrop complex, cut land, 5 to 100 percent slopes	LxG	High
Udorthents, graded, 15 to 55 percent slopes	UgF	High

<b>RITCHIE</b>		
<b>Name</b>	<b>Symbol</b>	<b>Soil Slip Potential</b>
Vandalia silty clay loam, 20 to 30 percent slopes, severely eroded	VdD3	High

<b>ROANE</b>		
<b>Name</b>	<b>Symbol</b>	<b>Soil Slip Potential</b>
Vandalia silt loam, 15 to 25 percent slopes	VaD	HIGH

<b>TAYLOR</b>		
<b>Name</b>	<b>Symbol</b>	<b>Soil Slip Potential</b>
Clarksburg silt loam, 15 to 25 percent slopes	CID	HIGH
Clarksburg silt loam, 15 to 25 percent slopes, severely eroded	CID3	HIGH
Culleoka silt loam, 25 to 35 percent slopes	CuE	HIGH
Culleoka silt loam, 25 to 35 percent slopes, severely eroded	CuE3	HIGH
Culleoka silt loam, 35 to 60 percent slopes, severely eroded	CuF3	HIGH
Dekalb extremely stony sandy loam, very steep	DSF	HIGH
Ernest silt loam, 15 to 25 percent slopes	EnD	HIGH
Ernest very stony silt loam, 15 to 35 percent slopes	EsD	HIGH
Faywood silty clay loam, 15 to 25 percent slopes	FaD	HIGH
Faywood silty clay loam, 25 to 35 percent slopes	FaE	HIGH
Faywood silty clay loam, 35 to 60 percent slopes	FaF	HIGH
Gilpin silt loam, 25 to 35 percent slopes	GIE	HIGH
Gilpin silt loam, 35 to 70 percent slopes	GIF	HIGH
Gilpin very stony silt loam, 15 to 35 percent slopes	GsE	HIGH
Gilpin very stony silt loam, very steep	GTF	HIGH
Gilpin-Upshur complex, 15 to 25 percent slopes	GuD	HIGH
Gilpin-Upshur complex, 15 to 25 percent slopes, severely eroded	GuD3	HIGH
Gilpin-Upshur complex, 25 to 35 percent slopes	GuE	HIGH
Gilpin-Upshur complex, 25 to 35 percent slopes, severely eroded	GuE3	HIGH
Gilpin-Upshur complex, 35 to 70 percent slopes, severely eroded	GuF3	HIGH
Guernsey silt loam, 8 to 15 percent slopes	GyC	HIGH
Guernsey silt loam, 15 to 25 percent slopes	GyD	HIGH
Guernsey silt loam, 15 to 25 percent slopes, severely eroded	GyD3	HIGH

<b>Name</b>	<b>Symbol</b>	<b>Soil Slip Potential</b>
Upshur silty clay, 15 to 25 percent slopes, severely eroded	UhD3	HIGH
Vandalia silty clay loam, 15 to 25 percent slopes	VaD	HIGH
Vandalia silty clay loam, 15 to 25 percent slopes, severely eroded	VaD3	HIGH
Westmoreland silt loam, 25 to 35 percent slopes	WmE	HIGH
Westmoreland silt loam, 25 to 35 percent slopes, severely eroded	WmE3	HIGH
Westmoreland silt loam, 35 to 60 percent slopes	WmF	HIGH

<b>TYLER</b>		
<b>Name</b>	<b>Symbol</b>	<b>Soil Slip Potential</b>
Cedarcreek channery silt loam, steep, stony	CeE	High
Gilpin-Upshur complex, 15 to 25 percent slopes	GpD	High
Gilpin-Upshur complex, 25 to 35 percent slopes	GpE	High
Gilpin-Upshur complex, 35 to 70 percent slopes	GpF	High
Gilpin-Upshur complex, 15 to 25 percent slopes, severely eroded	GwD3	High
Gilpin-Upshur complex, 25 to 35 percent slopes, severely eroded	GwE3	High
Gilpin-Upshur-Rock outcrop complex, 35 to 70 percent slopes	GxF	High
Vandalia silt loam, 15 to 25 percent slopes	VaD	High
Vandalia silt loam, 15 to 25 percent slopes, very stony	VbD	High

<b>UPSHUR</b>		
<b>Name</b>	<b>Symbol</b>	<b>Soil Slip Potential</b>
Gilpin-Upshur silt loams, 15 to 25 percent slopes	GuD	High
Gilpin-Upshur silt loams, 25 to 35 percent slopes	GuE	High
Gilpin-Upshur silt loams, 35 to 65 percent slopes	GuF	High
Gilpin-Upshur complex, 15 to 25 percent slopes, severely eroded	GwD3	High
Gilpin-Upshur complex, 25 to 35 percent slopes, severely eroded	GwE3	High
Vandalia silt loam, 15 to 25 percent slopes	VaD	High
Westmoreland-Upshur silt loams, 25 to 35 percent slopes	WuE	High
Westmoreland-Upshur silt loams, 35 to 65 percent slopes	WuF	High



<b>WEBSTER</b>		
<b>Name</b>	<b>Symbol</b>	<b>Soil Slip Potential</b>
Clifftop channery silt loam, 35 to 70 percent slopes, very stony	CnF	High
Clifftop-Dekalb complex, 15 to 35 percent slopes, extremely stony	CpE	High
Clifftop-Laidig association, very steep, extremely stony	CSF	High
Pineville-Clifftop complex, 55 to 70 percent slopes, extremely stony	PfG	High

<b>WETZEL</b>		
<b>Name</b>	<b>Symbol</b>	<b>Soil Slip Potential</b>
Gilpin-Peabody complex, 15 to 25 percent slopes	GpD	High
Gilpin-Peabody complex, 25 to 35 percent slopes	GpE	High
Gilpin-Peabody complex, 35 to 70 percent slopes	GpF	High
Gilpin-Rock outcrop complex, very steep	GrF	High
Vandalia silty clay loam, 15 to 25 percent slopes	VaD	High
Vandalia silty clay loam, 25 to 35 percent slopes	VaE	High
Vandalia silty clay loam, 15 to 25 percent slopes, extremely stony	VbD	High
Vandalia-Urban land complex, 15 to 25 percent slopes	VuD	High

<b>WIRT</b>		
<b>Name</b>	<b>Symbol</b>	<b>Soil Slip Potential</b>
Peabody-Gilpin complex, 40 to 55 percent slopes	PgF	High
Peabody-Gilpin complex, 30 to 55 percent slopes, severely eroded	PgF3	High
Peabody-Gilpin complex, 30 to 55 percent slopes, very stony	PvF	High
Upshur-Gilpin complex, 20 to 30 percent slopes	UgD	High
Upshur-Gilpin complex, 20 to 30 percent slopes, severely eroded	UgD3	High
Upshur-Gilpin complex, 30 to 40 percent slopes	UgE	High
Upshur-Gilpin complex, 30 to 40 percent slopes, severely eroded	UgE3	High
Vandalia silty clay loam, 20 to 30 percent slopes, severely eroded	VaD3	High

<b>WOOD</b>		
<b>Name</b>	<b>Symbol</b>	<b>Soil Slip Potential</b>
Peabody-Gilpin complex, 40 to 55 percent slopes	PgF	High
Peabody-Gilpin complex, 30 to 55 percent slopes, severely eroded	PgF3	High
Peabody-Gilpin complex, 30 to 55 percent slopes, very stony	PvF	High
Upshur-Gilpin complex, 20 to 30 percent slopes	UgD	High
Upshur-Gilpin complex, 20 to 30 percent slopes, severely eroded	UgD3	High
Upshur-Gilpin complex, 30 to 40 percent slopes	UgE	High
Upshur-Gilpin complex, 30 to 40 percent slopes, severely eroded	UgE3	High
Vandalia silty clay loam, 20 to 30 percent slopes, severely eroded	VaD3	High

Counties with no known High Slip Potential Soils:

Berkeley, Boone, Grant, Hardy, Greenbrier, Hampshire, Mineral, Logan, Mingo, McDowell, Mercer, Monroe, Pendleton, Pocahontas, Preston, Randolph, Summers, Tucker, Wyoming