



OPW[®]

R

O

FUELING CONTAINMENT SYSTEMS

Flexible Underground Piping Manual

Product Manual * Publication Number: UPM-0001 * Issue Date: 04/28/11
Supersedes: 05/27/09

FlexWORKS
BY OPW FUELING CONTAINMENT SYSTEMS

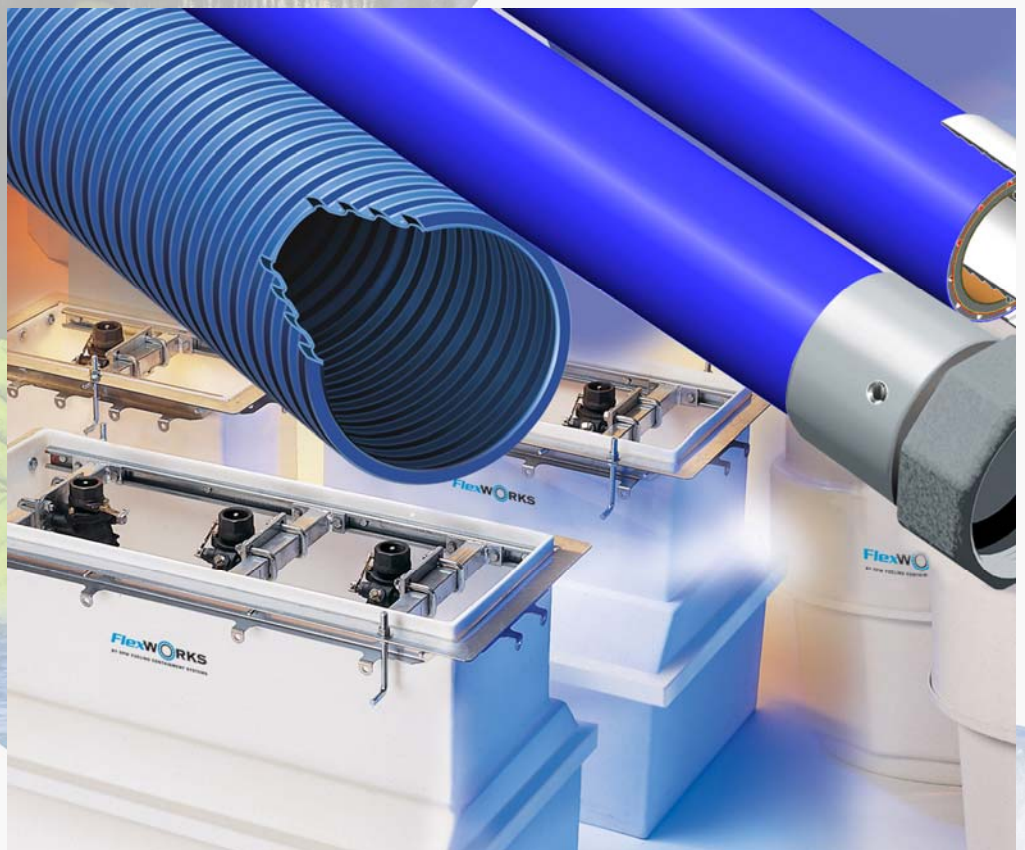

ONE COMPANY. ONE WORLD. ONE SOURCE.™

IMPORTANT INFORMATION FOLLOW ALL INSTRUCTIONS

INDEX

- 1.0 Introduction
- 2.0 Specifying Flexible Piping
- 3.0 Flexible Piping Connections
- 4.0 Flexible Pipe Accessories
- 5.0 Installer Tools
- 6.0 Pre-Installation Planning
- 7.0 Piping Design Criteria
- 8.0 Pipe Burial Requirements
- 9.0 Flexible Piping Options
- 10.0 Installing Duct Conduit
- 11.0 Tank Sump Plumbing Trees
- 12.0 Dispenser Sump Pipe Connections
- 13.0 Flexible Pipe Fabrication
- 14.0 Piping Connections
- 15.0 Test Boots
- 16.0 Tubing Assemblies
- 17.0 Flexible Vent Piping
- 18.0 Testing & Filling Supply Pipe
- 19.0 Periodic Line Leak Detection
- 20.0 Interstitial Integrity Testing
- 21.0 FlexWorks System Maintenance
- 22.0 Periodic Interstitial Testing
- 23.0 Problems
- 24.0 Guide Specifications
- 25.0 Storage and Handling

IMPORTANT INFORMATION - FOLLOW ALL INSTRUCTIONS
Please contact your OPW-FCS sales representative or OPW-FCS customer service representative at 1-800-422-2525 for OPW-FCS products installation procedures. All OPW-FCS literature including installation instruction sheets and manuals can be accessed from the OPW-FCS website at: www.opwglobal.com.

The use of non-qualified personnel or any deviations from these recommended procedures could result in damage or leakage of the system.

Manual Abbreviations:

PS = Integral Primary/Secondary Pipe
NV = Normal Vent
VR = Vapor Recovery
PP = Petroleum Products
Pri = Primary
Sec = Secondary
WP = Working Pressure
PC = Primary Carrier Pipe
MV = Motor Vehicle Fuels

1.0 INTRODUCTION

The FlexWorks family of products by OPW-FCS offers a full line of flexible piping and pipe connection products to provide an environmentally safe means of conveying fuels from underground storage tanks to above ground fuel dispensers. The variety of piping and pipe connections available allows for a wide range of pipe routing options to meet any site design requirements.

Flexible piping has proven to be safer than conventional rigid piping which requires numerous connection joints and directional fittings. In addition, flexible piping has proven to be considerably faster to install and more cost effective than rigid piping.



1.1 General Information

This product manual contains useful information about all types of flexible piping products and their associated connections, accessories and installer tools. It is required that this manual be read prior to specifying and installing flexible piping. The installation practices shall comply with these installation instructions contained within this product manual in order for the piping system warranty to be valid. **IMPORTANT: OPW-FCS system components may only be installed and serviced by a factory trained and currently certified installer in order for the product warranty to be valid. The use of non-certified personnel or any deviations from these written procedures could result in damage or leakage of the system and void the product warranty. Contact OPW-FCS's Customer Service Department for more information at 866-547-1816.**

1.2 Certifications and Approvals

Each of OPW-FCS's flexible piping systems carry various global approvals based on the individual construction of each type of pipe.

1.2.1. UL Listings

FlexWorks double wall piping is listed with Underwriter's Laboratories (UL®) under file #MH16678 and labeled as follows: Motor Vehicle Fuels, High Blend Fuels, Concentrated Fuels and Aviation and Marine.



UL Listed Fuels

Below are the listed fuels that have been tested under UL 971 and are warranted for use with the FlexWorks piping system.

Motor Vehicle Fuels

100% ASTM Reference Fuel No. 2
100% ASTM Reference Fuel C
85% Reference Fuel C – 15% MTBE
70% Reference Fuel C – 30% Ethanol
85% Reference Fuel C – 15% Methanol

High Blend Fuels

50% Reference Fuel C - 50% Methanol
50% Reference Fuel C - 50% Ethanol

Concentrated Fuels

100% Methanol
100% Ethanol
100% Toluene

Aviation and Marine Fuels

100% Premium Leaded Gas
100% Kerosene

WARNING: FlexWorks piping is not warranted for above ground transmission of flammable liquids due to the possible exposure to fire.

1.3 Piping Applications

OPW-FCS's flexible supply piping can be direct buried underground or installed inside a flexible conduit.

- Pressure System Supply Piping
- Suction System Supply Piping
- *Marina Supply Piping
- Vent Piping
- Remote Fill Lines

*Properly designed applications, such as under dock marina applications may be allowed with special approval and warranty restrictions. Other above ground applications containing flammables must have prior written approval and authorization from OPW-FCS for warranty coverage. All installation practices shall comply with the installation instructions contained within this and other OPW-FCS product manuals.

WARNING: Flex piping is not warranted for above ground transmission of flammable liquids due to the possible exposure to fire.

1.4 Operating Pressures and Temperatures

OPW-FCS flexible piping and its associated fitting systems have a minimum five to one (5:1) safety factor from maximum rated operating pressure for the primary pipe. The product fluids transferred should not exceed the maximum operating pressures indicated on each pipe size. For suction systems the pipe is capable of withstanding 29" mercury vacuum. The maximum temperature rating of OPW FCS's flexible piping is 125°F (52°C).

Pipe Size	Maximum Working Pressure Rating
3/4"	145 psi
1"	125 psi
1-1/2"	100 psi
2"	75 psi
3"	75 psi

1.5 Warranted Fuels

Warranted fuels are listed as follows:

- Gasoline
- Gasohol
- Ethanol
- Methanol
- Alcohol fuels
- Av-gas
- Kerosene
- Diesel Fuels
- Motor Oils
- Jet "A"

Contact OPW-FCS for chemical compatibility of fluids not listed above.

1.6 Pipe Packaging

OPW-FCS's flexible piping systems are available in a variety of piping diameters on continuous rolls and packaged in easy to handle protective cartons and reels. Refer to the *OPW-FCS Product Price List* for pipe diameters and packaging specifications.



CAUTION: Do not use knives or razor blades to open carton as damage to piping could occur.

2.0 SPECIFYING FLEXIBLE PIPING

OPW-FCS's flexible piping systems offers a variety of piping options for underground fuel delivery applications. Prior to specifying the type of piping required, read section 6 of this manual entitled "Pre-Installation Planning".

2.1 Flex Supply Piping

FlexWorks flexible supply piping is designed for direct burial as well as indirect burial within flexible ducting for future replacement capabilities. OPW-FCS's supply piping is totally bonded multi-layer composite construction. The inner-most barrier layer is smooth, which enhances hydraulic flow efficiency, and is virtually impervious to gasoline, alcohol blends and a wide variety of other fuels and chemicals. The exterior of the pipe also has a barrier layer to protect the outer wall of the pipe from chemical and microbial attack. OPW-FCS's flexible supply piping is available in double wall in continuous lengths.

2.2 FlexWorks Double Piping

A UL listed double wall flexible supply piping system that is designed for installation within Access piping. The outer containment jacket includes inner stand-off ribs to create a small interstitial space which allows for optimum fluid migration, continuous monitoring and easy periodic testing. This piping features an enhanced construction that meets the new UL971 standard.

2.3 Access Pipe

Access Pipe is a large diameter corrugated flexible piping that adds additional protection to OPW-FCS's flexible piping and allows the pipe to be removed and replaced without excavation. Made of high density polyethylene, this corrugated tube is strong enough to withstand H-20 loading requirements when properly buried and thick enough to minimize damage from shipping and jobsite handling. Access Pipe can accommodate the 3/4", 1", 1-1/2", 2" and 3" Flex supply pipe.



3.0 FLEX PIPING CONNECTIONS

OPW-FCS offers three types of piping connection systems for use with their flexible piping systems. These three different piping connections can accommodate a wide variety of piping designs, layouts and installation applications.

Coax Couplings & Fittings

These piping connections are made of a combination of glass reinforced plastic and stainless steel featuring a double wall design. Coax fittings require the use of the Flex Coupling Machine to install the pipe couplings.

Swivel Couplings & Fittings

These piping connections are made of stainless and protected steel featuring a swivel nut connection with a Viton gasket seal. Swivel fittings require the use of the Flex Coupling Machine to install the pipe couplings.



3.1 Coax Couplings & Fittings

Coax couplings & fittings are a double wall design and are used to interconnect FlexWorks piping. These UL® listed composite couplings and fittings permit the entire flexible piping system, including riser pipes to be secondarily contained, tested and monitored. The coax couplings & fittings are available in 1-1/2" and 2" sizes.

3.1.1 Coax Pipe Couplings

These couplings provide a means of connection from OPW-FCS's flexible piping to coax fittings and adapters. Coaxial pipe couplings attach to a flexible pipe section using the OPW-FCS Coupling Machine. Each coupling assembly includes a stainless steel insert with two O-rings, ferrule with one O-ring, and a swivel nut. Available for both single wall and double wall applications.



NOTE: Coax couplings require a different face plate to be used with OPW-FCS's coupling machine than is used with the swivel couplings.

3.1.2 Coax Pipe Adapters

These adapters are designed to connect one end of a flexible pipe section fitted with a coax pipe coupling to a 2" NPT threaded female coupling or fitting. The adapter has a 1/4" threaded test port for future installation of coax test tube for testing the interstitial space of the double wall piping.

3.1.3 Coax Connector Coupling

These connectors are designed to connect two flexible pipe sections fitted with coax pipe couplings. This is ideal when using extra-long piping runs and when connecting short lengths of flexible piping together. They can be direct buried, so containment sumps are not required.



3.1.4 Coax Tee Fitting

These tee fittings may be used in two different applications. The first application is to connect two sections of OPW-FCS's flexible piping fitted with coax couplings to a riser pipe. This application is used in any configuration where connection of a tee to a standard threaded riser pipe or flex connector is needed. Connection to a threaded riser pipe requires the use of a coax riser pipe adapter or riser jacket kit described later in this publication. The second application for coax tee fittings is to branch three sections of flexible pipe.



3.1.5 Coax Test Cap

Coax test caps are used to test the integrity of each primary & secondary pipe section. See section 5.5 for more details.



3.1.6 Coax Elbow Fitting

These elbow fittings may be used in two different applications. The first application is to connect a section of OPW-FCS's flexible piping fitted with a coax coupling to a riser pipe or flex connector. This application is used to terminate a piping run with a standard threaded riser

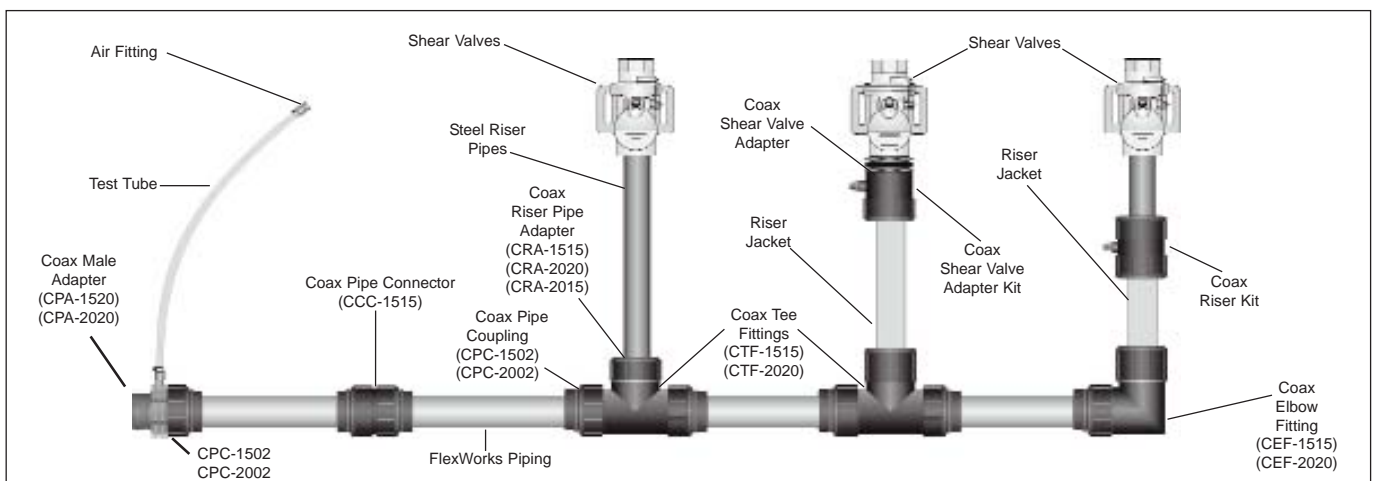

pipe. Connector to a threaded riser pipe requires the use of a coax riser pipe adapter or riser jacket kit described later in this publication. The second application for coax elbow fittings is to connect two sections of flexible piping fitted with coax couplings. This is useful when a sharp 90° degree turn is required.



3.1.7 Coax Riser Pipe Adapter

These adapters contain a female pipe thread on one side and a custom coaxial male face w/O-rings to accept coax fitting at the opposite end. These adapters are used with coax tee fittings and coax elbow fittings where interfacing with a standard threaded riser pipe or flex connector required.



3.1.8 Coax Riser Kit

The coax riser kit is used when isolation of a partial length of the riser pipe is required. The kit consists of a coax riser pipe adapter, coax riser adapter, two riser pipe nuts, coax riser plug w/O-rings, seals and a 36" length of coax riser jacket. The coax riser jacket is a UL listed, nonmetallic stand-off jacket that provides isolation from the environment as well as interstitial space for monitoring.



3.1.9 Coax Shear Valve Kit

The coax shear valve kit is used when the isolation of the full length riser pipe is required in a direct burial application. The kit consists of a coax riser adapter, coax shear valve adapter, two riser pipe nuts, one extra long riser adapter nut, coax riser plug w/O-rings, seals and a 36" length of coax riser jacket. The coax riser jacket is a UL listed, nonmetallic stand-off jacket that provides isolation from ground environment as well as interstitial space for monitoring. 2" male NPT base-threaded shear valves such as those available through OPW-FCS, are required for the coax shear valve kit.

5.6 Test Gauge Assembly

This air gage assembly provides a means of testing only the interstitial space of double wall piping. These gauges connect to the end of the test tubes and have a maximum pressure

3.2 Swivel Couplings & Fittings

Swivel couplings & fittings are of a single wall design and are used to interconnect OPW-FCS's flexible piping. These UL® listed stainless steel couplings and fittings may not be directly buried and must be installed within containment sumps. Double wall piping requires the use of rubber test boots to seal-off the interstitial space of double wall flexible piping. For flexible double wall piping applications which are routed in series, the metallic junction tees should be fitted with connector tubes to permit the interstitial space of the piping to bypass the single wall coupling and fitting. Swivel fittings are standard in NPT threads. The metallic couplings & fitting components are available in 3/4", 1, 1-1/2", 2" and 3" sizes and are illustrated below.

3.2.1 Swivel Pipe Couplings (SPC Series)

Available only in single wall design for attachment to OPW-FCS's piping, these metallic couplings fasten to the end of a flexible pipe section using the FlexWorks Coupling Machine. Each coupling assembly includes a stainless steel insert, stainless steel ferrule, stainless steel swivel nut and flat Viton gasket. Swivel couplings require a different face plate to be used with the FlexWorks Coupling Machine than is used with coax couplings.



3.2.2 Double Wall Swivel Pipe Couplings (DPC Series)

Double Wall Swivel couplings and fittings are of a double wall design and are used to interconnect FlexWorks flexible piping. These UL/ ULC listed stainless steel couplings must be contained within containment sumps and not directly buried.



The pipe connection system includes an internally expanded stainless steel coupling attached to the end of a FlexWorks pipe section. The swivel coupling has a smooth sealing face fitted with a viton ring gasket. Double wall Swivel Couplings eliminate the need for cutting back the secondary jacket and rubber test boots. They have an integral interstitial access port for connector and test tubes.

Please see FlexWorks publication DPC-0001, *Installation Instructions for Double Wall Couplings (DPC) and Test Tubes (TTT and TCT)*.

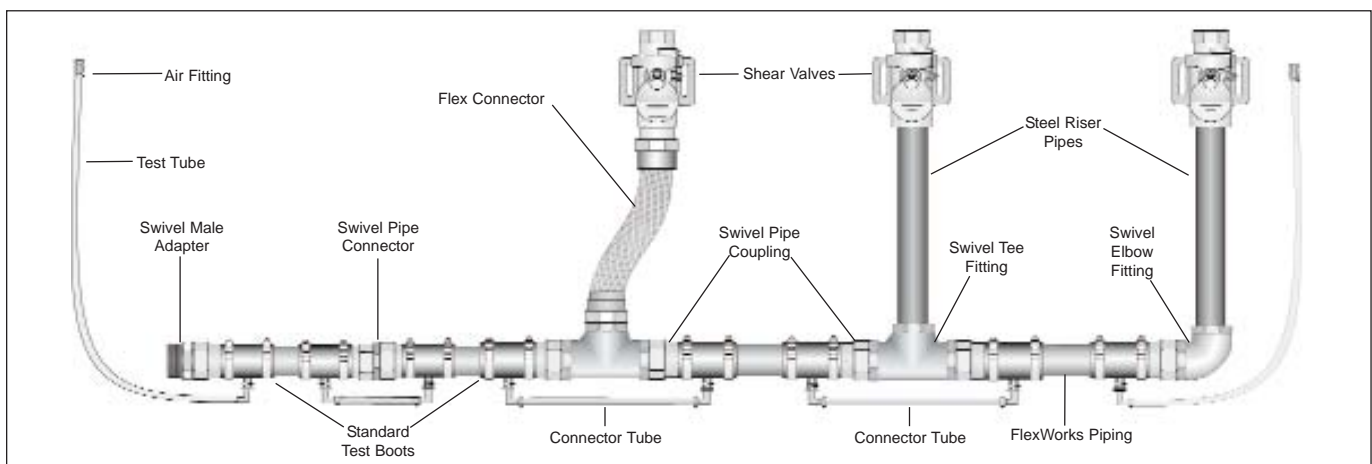

3.2.3 Swivel Male Adapters

Male pipe adapters are designed to connect one end of a flexible pipe section fitted with a swivel pipe coupling to a threaded female coupling or fitting. These metallic adapters have a male pipe thread on one end and a custom male thread to accept the swivel pipe coupling.



3.2.4 Swivel Female Adapters

Female pipe adapters are designed to connect one end of a flexible pipe section fitted with a swivel pipe coupling to a threaded male coupling, fitting, or threaded pipe nipple. These metallic adapters have a female pipe thread on one end and a custom male thread to accept the swivel pipe coupling.



3.2.5 Swivel Pipe Connectors

These connectors are designed to connect two flexible pipe sections fitted with swivel pipe coupling. These connectors cannot be directly buried and are required to be installed inside a containment sump. When used with double wall piping, it is recommended that test boots with connector tubes be used.



3.2.6 Swivel Junction Tees

These tee fittings are used in pres-sure type piping systems whereby the piping is routed in series. These tee fittings connect two flexible pipe sections fitted with swivel pipe couplings at the horizontal openings to a riser pipe at the vertical opening. When used with double wall piping, test boots with connector tubes are recommended.



3.2.7 Swivel Terminating Elbows

These elbow fittings can be used in both pressure and suction type piping systems when the piping is routed in series or direct. These elbow fittings connect one flexible pipe section fitted with a swivel pipe coupling at the horizontal opening and connect to a riser pipe at the vertical opening. When used with double wall piping, test boots with connector tubes are recommended.



3.2.8 Swivel Y Fitting

This adapter is designed to accommodate two flexible piping lines exiting a tank sump. This adapter has a 2" NPT female threaded opening at the top end and two downward facing openings which provide 1-1/2" NPT male threads.



4.0 FLEXWORKS PIPE ACCESSORIES

There are a variety of accessory components which may be used with OPW-FCS's flexible piping systems.

4.1 Standard Test Boots and Reducer Test Boots

When OPW-FCS's double wall flexible piping is fitted with swivel couplings, you can incorporate the use of rubber test boots and small diameter plastic tubing to provide access to the interstitial space of the double wall piping. One end of the rubber test boot clamps down onto the outside of the secondary jacket and the other end of the boot is clamped onto the outside of the ferrule of the swivel pipe coupling. The test boot includes a rubber boot and two band clamps.

NOTE: The test boots are not used with coax fittings & couplings.

4.2 Test Tubes

These 36" long plastic tube assemblies are designed to provide access to the beginning and end of the interstitial space of double wall pipe for initial and periodic air pressure testing. There are two types of test tubes available for use. One type is used with test boots and fitted with a barbed elbow and stainless steel band clamp on the lower end for insertion and clamping into the test boot port. The other type, the coax test tube is used with the coax pipe adapter and fitted with a 1/4" NPT male nylon threaded fitting for connection to the threaded test port.

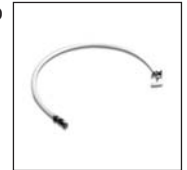

4.3 Connector Tubes

These short plastic tube assemblies are designed to reroute the interstitial space of one double wall flexible pipe section around a metallic junction tee fitting to the next double wall flexible pipe section. They come fitted on each end with a barbed air stem coupling elbow and stainless steel band clamp for insertion and clamping into the test boot port.



NOTE: The connector tubes are not used with coax fittings and couplings.

4.4 Crossover Supports

These two piece supports are used to separate flexible piping runs at all crossover intersections, providing sufficient support to prevent the upper pipe from deforming the lower pipe.



5.0 INSTALLER TOOLS

OPW-FCS offers a variety of Installer tools for installing OPW-FCS's flexible piping system.

NOTE: To insure proper installation and product warranty coverage, only OPW-FCS pipe coupling equipment and pipe fabricating tools must be used.



5.1 Pipe Cutter

The FlexWorks pipe cutter is designed to produce a clean and even pipe cut which is necessary for proper coupling attachment.



5.2 Jacket Cutter

This stripping tool is used to strip off a section of the secondary jacket on the outside of the double wall piping. This is required for installation of swivel pipe couplings.



NOTE: When using coax pipe couplings, do not strip the secondary jacket of the pipe.

5.3 Coupling Machine

The FlexWorks Coupling Machine is required for the installation of both coax and swivel pipe couplings. This electrically-driven hydraulic machine is designed to internally expand the metal pipe insert installed at the end of a flexible pipe section. Coupling machines are available in both 110 and 220 volt models. Consult your local OPW-FCS distributor for availability for rental or purchase of the coupling machines. Remote coupling machines are also available.



IMPORTANT: Before and after the coupling process, the supplied dust cover should be kept on the couplings. This precaution will lessen the possibility of damage.

5.4 Swivel Wrench

This open ended wrench is sized to fit the swivel nut of the swivel pipe coupling. It is used to tighten the swivel nut on a metallic fitting, adapter or connector.



NOTE: When installing swivel couplings, hand tighten the coupling onto the OPW-FCS fitting until it is snug. With an OPW-FCS Swivel Wrench, tighten the coupling nut 1/4 turn more or to 200 in/lbs. Do not allow the pipe to rotate during tightening. This procedure will prevent over tightening of the coupling past the maximum 200 in/lbs.

5.5 Test Caps

These custom threaded plugs have a 1/4" NPT port in the end for attachment of an air gauge or a valve stem (not included). Test caps are used to test the integrity of each pipe section prior to installation.



5.5.1 Coax Test Caps

Coax test caps are available to test 1-1/2" and 2" pipe sizes and attach to coax fittings. Both the primary pipe and secondary jacket of the double wall pipe section can be tested with the coax test cap.



5.6 Test Gauge Assembly

This air gauge assembly provides a means of testing only the interstitial space of double wall piping. These gauges connect to the end of the test tubes and have a maximum pressure rating of 15 psi.



5.7 Fishing Bullnose

Attaches to the end of a flexible pipe section in order to fish (push or pull) the flexible pipe section through the Access Pipe. Its rounded nose provides an easy means of feeding the pipe through the Access Pipe. The swivel bullnoses are fitted with a metal eyelet for attachment of a plumber's fish. Available in 1-1/2" and 2" pipe sizes for attachment to both coax pipe couplings and metallic pipe couplings.



6.0 PRE-INSTALLATION PLANNING

The type of pipe routing design selected is dependent on the quantity and orientation of the dispensers, the type of system (either pressure or suction) and the layout of the facility. One constant design requirement is that all piping that runs between containment sumps be continuous. Single and dual piping lines may be used depending on the total quantity of dispensers to be serviced and the location and orientation of the islands. The pipe routing design criteria for OPW-FCS's flexible piping system is considerably different than that of conventional rigid piping. For either new or retrofit installations, good pre-installation planning is a must to insure a proper installation.

6.1 Single Series Routing

This system is used in "pressure" systems where one piping line interconnects all of the product dispensers.

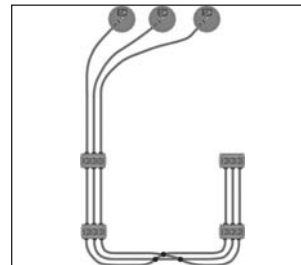

6.2 Dual Series Routing

This system is used in "pressure" systems where two piping lines interconnect all the dispensers divided equally.

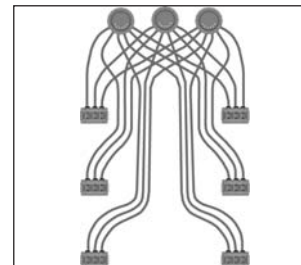
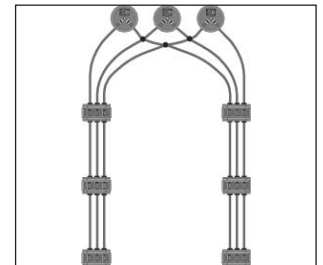

6.3 Direct Routing

This system is used in "suction" systems where one piping line is directly connected to only one dispenser inlet.

7.0 PIPING DESIGN CRITERIA

When designing and installing Flex piping systems, use the following criteria to insure that they meet OPW-FCS's requirements:

7.1 Piping Turns

Piping trenches should be cut with sweeping turns. Flexible piping turns require specific radii depending on the pipe diameter. Piping turns should not be less than:

.75" - 18" radius

1.0" - 18" radius

1.5" - 24" radius

2" - 36" radius

3" - 72" radius

7.2 Piping Crossovers

For flexible piping systems which have piping crossovers, install the crossover supports at each intersection. 1-1/2" and 2" only.

Note: When crossover supports are not available, a minimum compacted layer of either 2" of approved pea gravel or crushed stone or 4" of approved sand backfill must separate each pipe.

7.3 Piping Supply Capacity

For a pressure piping system using single piping runs routed in series, no more than a total of six dispensing nozzles should be serviced with a 1-1/2" single piping line to prevent unacceptable product flow rates. Consult OPW-FCS's customer service department for flow rate calculations.

7.4 Vent Piping Fall

If Vent Piping is used for vent lines, make sure there is adequate fall back to the tank from the vent stack. OPW-FCS requires a minimum 1/8" per foot slope for all vent lines.

7.5 Product Sequence

The dispensing product sequence will alternate from one dispenser to the next when "loop-around" is used. Pipe crossovers are recommended at these points to correct the change in product sequence in "series" routing of pressure piping systems.

8.0 PIPE BURIAL REQUIREMENTS

OPW-FCS's flexible piping and access piping are strong, yet still flexible, piping systems and must be buried in such a manner that they will not compress. The burial requirements depend on proper pipe trenching, backfill material and burial depth. Follow these instructions for warranty compliance:

8.1 Trench Sizing

Piping trenches should be dug in such a manner that the trench width is equal to at least twice the width of all the flexible pipes contained within. All piping within the trench should be separated by the outside diameter of the piping being installed with a required minimum of 2" (50 mm) of separation for all piping. Trench turns should be sweeping rather than sharp angles. The bottom of the trench should be



compacted and as uniform as possible to eliminate high spots to insure an even layer of bedding material under the pipe. Remove all sharp rocks and debris from the trench bottom before bedding material is installed.

8.2 Bedding & Backfill Materials

Approved bedding and backfill materials for OPW-FCS's flexible piping, sumps and Access piping shall meet the following specifications:



8.2.1 Pea Gravel

Rounded pea gravel is permitted with a minimum diameter of 1/8" and a maximum diameter of 3/4".

8.2.2 Crushed Stone

Crushed stone is permitted providing it shall be washed clean and be of the free flowing type with an angular stone size between 1/8" and 1/2". (Meets ASTM C-33 paragraph 9.1 requirements.)

8.2.3 Sand

Sand backfill is permitted providing it shall be washed clean and is free flowing with a maximum content of 10% fines. When backfilling, make sure sand is evenly distributed and fully compacted under and fully around the piping.

NOTE: A minimum of 6" (152mm) of approved bedding material shall be spread and compacted evenly along the bottom of the piping trench. All bedding and backfill material should be clean and free from ice and snow and debris. Using material other than those described above without written approval from OPW-FCS Products Inc. will void the product warranty.

8.3 Flexible Pipe Sloping

If a continuous slope or "fall" is required from the last dispenser on a piping run to the tank, then the tanks should be buried at a sufficient depth and the pipe entry height into the dispenser sump should be of sufficient elevation so that 1/8" of fall per linear foot is maintained. **OPW-FCS does not require its flexible pipe to be sloped in pressure systems.**

8.3.1 Pressure Piping Systems

If the full system warranty is desired, the difference in elevation of the piping between two dispenser sumps must not be greater than 30". A pipe sensor must also be placed in the terminating dispenser sump or tank sump, whichever is at a lower elevation.

NOTE: Check your local code regulations for fall requirements other than that which is previously stated.

8.3.2 Suction Piping Systems

Sloping the OPW-FCS flexible piping from the dispenser back to the tank is always required for suction piping systems where maintaining prime is necessary. Shallow dispenser sumps are recommended for use in this application.

8.4 Pipe Trench Backfilling

Backfilling of the flexible Piping System should occur

only after the final integrity testing has been performed on both the primary and the secondary of the pipe. Prior to backfilling completely, hand shovel the backfill material between and to the outside of the pipe to maintain the minimum required spacing between the pipes and walls of the trench. Final backfilling shall be done slowly and evenly in 4" to 6" layers as not to disturb the spacing of the pipe and to insure no voids are present in the backfill. An additional air test is recommended after backfilling to insure the backfill process has not damaged the pipe.

NOTE: Use extra caution when backfilling around direct bury coax fittings. Avoid sharp impacts from backfill material and tools.

8.5 Overburden

The type of surface installed above the piping can have an overloading effect on the flexible piping. Follow the overburden specifications below for product warranty compliance.

CAUTION: FlexWorks piping and Access piping can be punctured by grade stakes or other sharp objects driven into the ground. The use of tracer tape or a schematic of the underground piping should be kept onsite and marked off prior to commencing any work that may damage the pipe.

8.5.1 Unpaved Surfaces

If the surface is unpaved, then a minimum of 18" (457mm) of approved backfill material should be installed between the top of all flexible piping and the top of the ground surface.

8.5.2 Paved Surfaces

If the surface is paved with either asphalt or concrete the total amount of pavement plus approved backfill material shall be a minimum of 18" (457mm) between the top of either the flexible piping and the top of the paved surface.

8.5.3 Access Pipe Burial

Whether the surface is paved or unpaved with either asphalt or concrete then there shall be a minimum of 16" (406mm) between the top of the Access Pipe and the top of the paved or unpaved surface.

9.0 FLEX PIPING OPTIONS

The OPW-FCS's Piping Systems offers several types of pipe coupling options. These options, in turn, allow for a variety of piping application options for the flexible pipe used in both pressure piping systems and suction piping systems.

9.1 Pipe Coupling Options

There are two types of pipe coupling options available for the OPW-FCS's flexible piping system. The first is coax couplings, which are a double wall non-metallic pipe coupling that can be used with OPW-FCS's flexible piping. The second is swivel couplings, which are made of stainless steel. Both are internally expanded onto the OPW-FCS's flexible piping using the FlexWorks coupling machine.

9.1.1 Coax Pipe Couplings-Double Wall

This pipe coupling option is connected to OPW-FCS's double wall piping. Having no exposed metal components, they are not susceptible to corrosion. Their double wall design allows the interstitial space of the double wall piping to pass through the coupling as well as the interconnected coax fittings and adapters.

9.1.2 Swivel Pipe Couplings

This pipe coupling is connected to OPW-FCS's double wall piping. Made entirely of stainless steel, the fittings must always be installed inside a containment sump. These fittings, when coupled with double wall flexible piping, require rubber test boots, connector tubes and test tubes to be installed for secondary pipe testing and continuous monitoring capabilities. These couplings will interconnect with all swivel fittings and adapters.

9.2 Piping Application Options

There are a variety of piping and containment options which may be used for a complete OPW-FCS flexible piping system.

9.2.1 Pressure Piping Systems

For this type of piping system there are a variety of piping applications available. They are described as follows:

Using Dispenser Sumps

This application includes the use of a tank sump interconnected with one or more dispenser sumps using flexible piping which may be directly buried or installed inside Duct chase piping. Because all fittings are contained, either coax or metallic couplings and fittings may be used.

9.2.2 Suction Piping Systems

For this type of piping system, there are a variety of piping applications available. They are described as follows:

Using Shallow Dispenser Sumps

This application includes the use of a tank sump interconnected with a dispenser sump using double wall flexible piping which may be directly buried or contained inside the Access Pipe. All fittings are contained, therefore either coax or metallic couplings and fittings may be used.

10.0 INSTALLING ACCESS PIPE

Access Pipe is a large diameter corrugated flexible piping that adds additional protection to OPW-FCS's flexible piping and allows the pipe to be removed and replaced without excavation. Measuring and cutting Access Pipe should be done prior to measuring and installing the primary piping. OPW-FCS recommends the installation of Access Pipe for all installations of flexible piping.

Note: For installation of flexible piping in Access Pipe when using coax couplings, refer to section 13.8.4.

10.1 Access Pipe Measuring

Prior to measuring for the Access Pipe, install the Access Pipe entry boots into the sidewall of the dispenser sump. Refer to the flexible entry boots installation manual for the proper installation procedures for these entry boots. Measure the distance from the sump wall of the first sump to the sump wall of the second sump. Make sure to follow the contour of the

trench. Add 4.25" to this figure and transfer measurement to the Access Pipe.

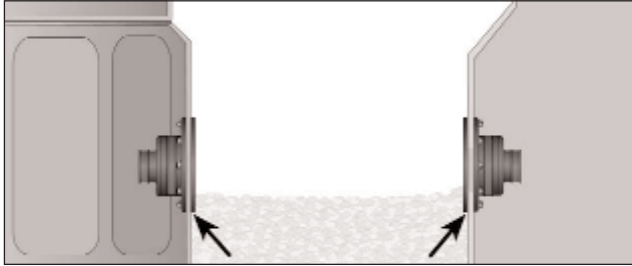

10.2 Access Pipe Cutting

Transfer measurement to the Access Pipe and make cut in the closest valley.

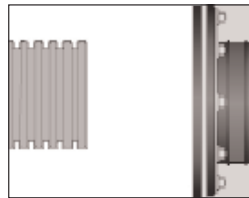

10.3 Access Pipe Connections

Insert the black stiffener into the Access Pipe, then insert the Access Pipe into the flexible boot from outside of the sump. Be sure the edge of the Access Pipe is flush with the inside face of the boot. After the Access Pipe has been positioned, install the band clamps around the boot. Repeat this same installation procedure with the other end of the Access Pipe section.

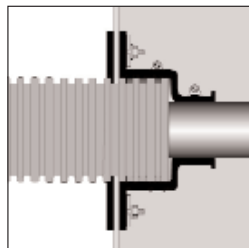

11.0 TANK SUMP PLUMBING TREES

The type of piping application used shall determine what type of piping connections shall be made inside the tank sump.

NOTE: Prior to assembling plumbing trees, be sure the OPW-FCS fittings are aligned with the pipe entries through the sump wall to prevent excessive bending of the pipe within the sump.

11.1 Pressure Supply Systems

For pressure piping systems, the flexible piping may be connected to the tank's submersible pump using the *Flex* fittings or a flexible connector. For this application, both single and dual line connections may be made.

11.1.1 Single Pipe Line To Pump Connections

This application includes a plumbing tree assembly which interconnects the submersible pump to a single flexible piping line. A typical pipe connection assembly would include a ball shut-off valve and standard plumbing elbow installed between the submersible pump and the pipe adapter, as shown.



For coax type connections, a plumbing assembly fitted with a standard plumbing elbow fitting would be connected to a coax

pipe adapter. This accommodates the connection of a coax pipe coupling installed on the end of a flexible pipe section. The adapter is attached by first applying the specified thread sealant to the male pipe threads. Then hand tighten firmly followed by two full turns with a pipe wrench.



CAUTION: Do not apply the plumbing wrench to the section of the pipe adapter which contains the test port.

NOTE: For coaxial fitting NPT threads, use only *UL* classified thread sealant specifically formulated for gasoline and petroleum products. Do not overtighten coax type fittings.

For swivel type piping connections, a plumbing assembly fitted with a standard plumbing elbow fitting would be connected to a swivel or barbed adapter. The arrangement accommodates the connection of a swivel pipe coupling installed on the end of a flexible pipe section.



11.1.2 Dual Pipe Lines To Pump Connections

This application includes a plumbing tree assembly which interconnects the submersible pump to two flexible piping lines. A typical connection assembly would include a tee fitting or a dual adapter fitting fitted with a ball shut-off valve and two standard plumbing elbows as shown.

For coax type connections, a plumbing assembly fitted with two standard plumbing elbow fittings would be connected to two coax pipe adapters. This arrangement accommodates the connection of coax pipe couplings which are installed on the end of two flexible pipe sections. The adapter is attached by first applying the specified thread sealant to the male pipe threads. Then hand tighten firmly followed by two full turns with a pipe wrench.

CAUTION: Do not apply the plumbing wrench to the section of the pipe adapter which contains the test port.

NOTE: For coaxial fitting NPT threads, use only *UL* classified thread sealant specifically formulated for gasoline and petroleum products. Do not overtighten coax type fittings.

For swivel type piping connections, a plumbing assembly fitted with two standard plumbing elbow fittings would be connected to swivel or barbed adapter. This arrangement is to accommodate the connection of swivel pipe couplings installed on the end of two flexible pipe.

11.2 Suction Supply Systems

For suction systems, all flexible piping connections are made directly into the tank. In this application typically a tank manway cover would be fitted with a multitude of female threaded tank fittings. These tank fittings should have pipe fittings, either a standard plumbing elbows or capped tees

installed and aligned facing the entry point of the flexible pipe sections.

11.2.1 Coax Connections To Tank Fittings

Install the coax pipe adapters into the pipe fittings to accommodate the coax pipe couplings installed to the end of the flexible pipe sections. The adapters are attached by first applying thread sealant to the male pipe threads. Then hand tighten firmly followed by two full turns with a pipe wrench.

CAUTION: Do not apply the plumbing wrench to the section of the pipe adapter which contains the test port.

NOTE: For coaxial fitting NPT threads, use only UL® classified thread sealant specifically formulated for gasoline and petroleum products. Do not overtighten coax type fittings.

11.2.2 Metallic Connections To Tank Fittings

Install the metallic pipe adapters into the pipe fittings to accommodate the metallic pipe couplings installed to the end of the flexible pipe sections.

12.0 DISPENSER SUMP PIPE CONNECTIONS

The plumbing connections required inside dispenser sumps can be simple or complicated depending upon the plumbing requirements, dispenser size, and pipe entry locations. Pipe entries that are located considerably off the center line may require the use of flex connectors as riser pipes instead of rigid steel riser pipes.

For some dispenser models, the pipe entries are located so close to the wall of the dispenser that product offsets are required. The type of piping application specified shall determine what type of piping connections shall be made inside dispenser sumps.

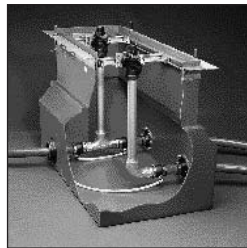

NOTE: Prior to all flexible piping connections in dispenser sumps the riser pipe assemblies must be installed and test boots, if used, must be installed.

12.1 Riser Pipe Assemblies

Riser pipe assemblies are designed to interconnect one or two flexible pipe sections to the above ground product dispenser. At the top end they may or may not be fitted with a shear valve and are typically mounted to a stabilizer bar. At the low end they may be fitted with either tee fittings or elbow fittings. Refer to the following riser pipe options available with OPW-FCS's flexible piping system.

12.1.1 Steel Pipe Riser Measuring:

Cutting the steel riser pipe to the proper length will allow the piping to enter the dispenser sump on a straight and level plane and in line with the tees, elbows and adapters. Improper riser length results in stress at the pipe fitting/pipe coupling connection. *Please follow the steps noted below:*

- Install the stabilizer bars in their proper position, per OPW FCS Stabilizer Bar Installation Instructions, which

can be determined by the dispenser manufacturer's footprint for the particular dispenser model. This will allow for proper vertical alignment.

- Install the shear valve to the shear valve mounting plate and secure this to the stabilizer bar in accordance with the dispenser manufacturer's footprint.
- Install the entry boots in accordance with the OPW-FCS Flexible Entry Boot installation instructions.
- Line up the center of the entry boot with the center of the opening of the tee, elbow or adapter.
- Determine the length of the steel riser by measuring between the bottom of the shear valve and the top of the tee, then add 1-1/2" to that length prior to cutting the NPT threads for each end of the riser.
- Install the riser to the top of the shear valve with the use of soft set pipe dope that is approved for use with petroleum products.
- Install the tee, elbow or adapter to the bottom of the riser, positioning it properly to align with the entry boot horizontally, with the use of soft set pipe dope that is approved for use with petroleum products.
- Reinstall the riser set up to the stabilizer bar and then make sure that the tee, elbow or adapter opening is on center with the entry boot opening on both the horizontal and vertical plane.
- Assure that the opening of the tees, elbows or adapters are all on center with the entry boot, on both the horizontal and vertical plane.

12.2 Non-Contained Riser Pipe

Non-contained riser pipe assemblies are only permitted if they are to be installed inside dispenser sumps. These riser pipes assemblies may have a coax or swivel fitting installed at the base of the steel riser pipe.

13.0 FLEXIBLE PIPE FABRICATION

After all plumbing trees have been installed inside the tank sumps and riser assemblies installed into either the deep or shallow dispenser sumps, fabrication and installation of the flexible piping may proceed.

IMPORTANT: Only currently certified contractors with a valid factory training card are authorized to install Flex piping.

13.1 Pipe Handling At Jobsite

Care must always be taken when handling OPW-FCS's flexible piping to prevent damage. It is recommended that the carton be placed in the sunlight several hours before measuring and cutting the pipe, so the pipe may relax for easier extension when measuring.

WARNING: Do not drag, cut or scrape the pipe during installation to avoid damage to the external surface of the piping. Use only OPW-FCS approved backfill

materials.

13.2 Cold Weather Pipe Handling

OPW-FCS's flexible piping can be installed in ambient temperatures as low as zero degrees, provided that the flexible piping has been sufficiently warmed prior to unrolling. If the pipe is unrolled and straightened while it is warm, it will cool in a straighter position making it easier to install. For cold weather installations where the ambient temperature is below 40° F (5° C), it is recommended that the piping cartons be placed in a warm room for 8 hours directly prior to installation. If this is not possible, then a small hole should be cut in the top center of the lid of the carton for insertion of the nozzle of a conventional hair dryer. For piping reels, place a tarp over the reel and then insert the hair dryer nozzle directly into the end of the piping. If this pipe warming procedure is used, do not use the first 12" of the pipe due to possible damage by the hair dryer. Depending on the ambient temperature, it may take up to an hour to warm the roll of piping sufficiently.



13.3 Flexible Pipe Measuring

When measuring the distance between containment sumps or pans to determine the proper length of a flexible pipe section to be installed, it is important to consider that the pipe is flexible and will not be installed perfectly straight. A slight weaving of the pipe in the piping trench is recommended to compensate for expansion and contraction. The recommended measuring and cutting procedures for the flexible piping are described below:

13.3.1 Direct Pipe Burial Applications

When measuring for direct burial of flexible piping, the measuring points will be from the face of one adapter/fitting to the next. If swivel couplings and fittings are used, subtract 1" to allow for the length of the two pipe couplings and cut the piping to that length. For coax application, no modification to the measurement is necessary.

13.3.2 Access Pipe Burial Applications

For Applications using Access Pipe, measurements must be taken through the Access Pipe to insure proper length. Feed the measuring tape through the Access Pipe and measure the distance from the face of the one adapter/fitting to the next. If swivel couplings and fittings are used, subtract 1" to allow for the length of the two pipe couplings and cut the piping to that length. For coax application, no modification to the measurement is necessary. See Access Pipe installation instructions for complete information and installation steps.

13.4 Flex Pipe Cutting

When cutting the piping into pipe sections, cut the pipe at the measured cut mark using the pipe cutter tool. This cutting tool is designed to make clean and even cuts in the piping. Clean and even piping cuts are necessary for the proper installation of the OPW-FCS pipe couplings.

13.4.1 Cutter Positioning

Mark the pipe where it is to be cut. Next position the blade of the pipe cutter over the mark.



13.4.2 Blade Activation

Squeeze the handles up and down to activate the movement of the blade. Continue until the blade will no longer continue to activate. This procedure will cause the pipe to slightly compress.



13.4.3 Pipe Cutting

Rotate the entire pipe cutter 1/4 turn to permit the blade to penetrate the wall of the pipe. Continue to squeeze the handles up and down to complete the entire pipe cut. Inspect the cut to make sure it is even.



NOTE: Do not rotate blade more than 1/4" turn. Inspect edge of cut and inside of piping after cutting for any signs of damage.

13.5 Stripping Containment Jacket

In order to install the swivel pipe coupling to the end of a double wall pipe section, it is necessary to strip off small sections of the outer stand-off containment jacket. The removal of this section of stand-off jacket permits the installation of the coupling or clamp which fits on the outside surface of the primary pipe section.

13.5.1 Strip Length Setting

There are two sets of holes on the body of the jacket cutter for the installation of a "stop pin" used to set the length of the jacket to be cut off.

NOTE: The secondary jacket is not removed when using coax couplings.

13.5.2 Pre-stripping

Raise and turn the handle to 45 degrees so the blade will be above the surface of the pipe.



13.5.3 Circular Cutting

Insert the end of the pipe section completely into the jacket cutter. Make sure the pipe bottoms against the stop pin. Next lower the handle so that it is perpendicular to the body of the jacket cutter. Rotate the cutter around the pipe two or three times to make a complete radial cut on the secondary jacket.



Note: Pipe must bottom out against stop pin to insure proper length of jacket is removed.

13.5.4 Linear Cutting

Raise and turn the handle 90 degrees so the handle will be parallel with the jacket cutter body. Pull the jacket cutter off the end of the pipe to make the linear cut on the secondary jacket.



13.5.5 Jacket Removal

Look closely for the linear cut down the pipe, and peel the secondary jacket away at that point from the primary inner pipe.

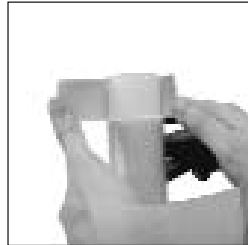

NOTE: To avoid damage to the pipe, do not use tools other than an OPW-FCS jacket cutter to strip the secondary jacket.

Inspect outer surface of primary pipe after jacket removal. For complete instructions, please refer to the jacket cutter installation instructions.

13.6 Coupling Flexible Pipe Sections

The flexible piping system requires the use of the *Flex* Coupling Machine for proper installation of the pipe couplings onto the flexible piping sections. Both coax couplings & fittings and metallic couplings and fittings may be coupled with the *Flex* coupling machine providing the correct face plates and swage is used.

IMPORTANT: Using the coupling machine with piping and/or couplings not manufactured by OPW-FCS shall void the coupling machine warranty. Before and after the coupling process the supplied dust cover should be kept on the coupling. This precaution will lessen the possibility of damage. For complete instructions, please refer to the Flex coupling machine installation instructions.

13.6.1 Machine Set-up

- Remove cover and install under the base.
- Install the correct face plate.
- Install the correct threaded shaft.
- Install the correct size swage kit.
- Open the vent plug.
- Plug in machine with extension cord.

IMPORTANT: Connect the coupling machine to a properly grounded outlet only. Piping must be held vertically throughout the coupling process.

WARNING: OPW-FCS's coupling machine is not intrinsically safe and can not be used in hazardous areas.

13.6.2 Positioning Swivel Pipe Coupling

Install the appropriate size faceplate, unscrew and remove

the tapered swage from the threaded shaft. Lubricate the inside of the coupling insert with metal assembly paste or white lithium grease. Insert the pipe coupling assembly, including the ferrule over the threaded shaft and seat it onto the face plate.

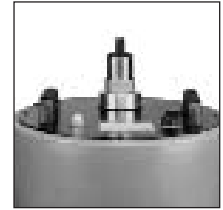

Note: Do not place ferrule on the piping. Ferrule must be inserted over the insert of the coupling.

13.6.3 Installing The Tapered Swage

Thread the tapered swage onto the threaded shaft until it meets the back of the pipe coupling assembly.

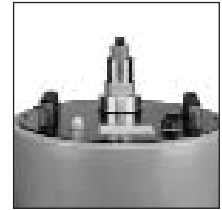

NOTE: Do not use silicone based lubricants. Be sure that the swivel nut of the pipe coupling assembly is flush against the face plate.

13.6.4 Inserting the Pipe

Insert the end of a flexible pipe section inside the pipe coupling until it bottoms out. Inspect the entire assembly, prior to switching on the machine for the following:

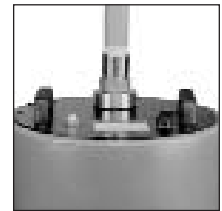

- Swivel nuts are flush against the base plate.
- The coupling and pipe are totally vertical.
- The ferrule is snug against the insert shoulder.

13.6.5 Swaging

To begin the swaging process, turn the switch to the DOWN position. Once the tapered swage passes through the pipe coupling assembly, the motor will turn off. Remove the coupled pipe section. Turn the switch to the UP position to allow the drive shaft to return to the starting position.



13.6.6 Inspection

Inspect the installed pipe coupling assembly inside and out to make sure there was no damage to the insert, ferrule or swivel nut during the swaging operation.

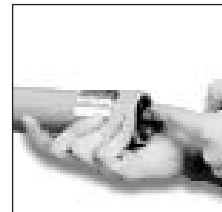

IMPORTANT: Using this coupling machine with pipe or couplings other than those manufactured by OPW Fueling Containment Systems, shall void the product warranty.

Note: Some flexible entry boots require at least partial installation onto the pipe before coupling. When using swivel couplings in direct bury applications, the studded portion of a DEB-6150 and DEB-6200 must be installed onto the pipe prior to coupling the pipe. All direct bury coax couplings require the entry boot or reducer donut to be installed prior to coupling the pipe.

PROPERLY INSTALLED SWIVEL COUPLING

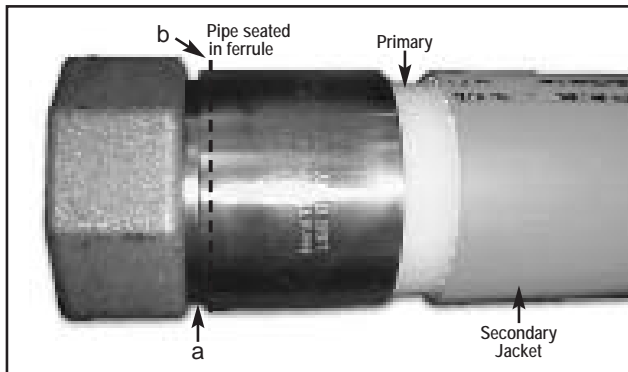

- Ferrule properly seated to insert shoulder.
- Primary pipe pushed to the front of the ferrule inside over all barbs at insert.

IMPROPERLY INSTALLED SWIVEL COUPLING

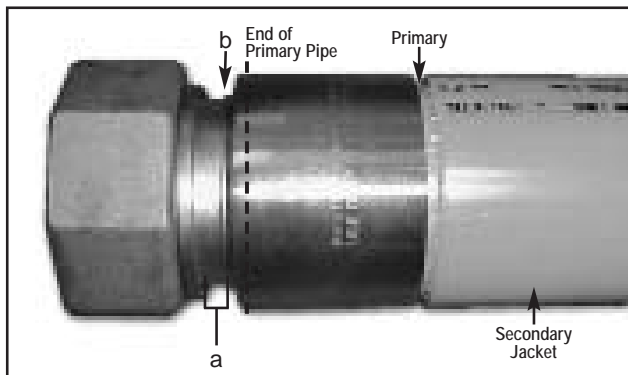

- Notice ferrule not pushed to insert shoulder.
- Piping not pushed over barbs completely.

13.6.7 Positioning Coax Pipe Coupling

Install the appropriate size faceplate, unscrew and remove the tapered swage from the threaded shaft. Lubricate the inside of the coupling insert with metal assembly paste or white lithium grease. Insert the pipe coupling assembly over the threaded shaft and push it down onto the face plate.



13.6.8 Installing The Tapered Swage
Thread the tapered swage onto the threaded shaft until it meets the back of the pipe coupling assembly.

NOTE: Do not use silicone based lubricants. Be sure that the swivel nut of the pipe coupling assembly is flush against the face plate.



13.6.9 Inserting the Pipe

Insert the end of a flexible pipe section inside the pipe coupling until it bottoms out. Inspect the entire assembly, prior to

switching on the machine. Make sure the pipe is completely vertical.

- Finish the coupling process as described in 13.6.5 and 13.6.6

IMPORTANT: For direct burial (non-Access Pipe) coax applications, loosely pre-install entry boot on pipe, studs facing downward, prior to inserting pipe on coupling. Replace orange dust cap after couplings.

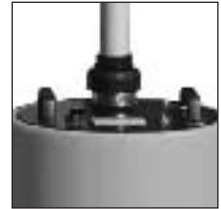

13.7 Installing Pipe Sections - Direct Burial (non-Access Pipe)

Once the pipe has been measured and the couplings have been installed, the pipe may be installed. This section discusses the installation in a direct burial application. Refer to section 13.8 for installation of the piping using Access Pipe.

13.7.1 Insert Piping Through Sump Wall

Take the pipe section to the trench and insert into the containment sump through the flexible entry boot. Make sure the band clamp of the entry boot has been removed or sufficiently loosened to permit the pipe to pass through the rubber boot. Tighten band clamps of the entry boots after the installation process has been completed. For junction sump applications, repeat procedure for adjoining pipe sections.



IMPORTANT: For direct burial (non-Access Pipe) coax applications, be sure to insert coupled pipe through opening in the side of the sump. Align studs of the flexible entry boot with stud holes in sump and push into place. Fasten the entry boot according to the installation instructions included with the boot.

13.7.2 Pipe Connection

After the flexible pipe(s) have been inserted, attach pipe to fittings using the methods described in section 14. Inspect the piping in the trench to make sure it is positioned properly in the trench between the containment sumps and there is sufficient pipe weaving back and forth to allow for pipe expansion and contraction.

13.8 Installing Pipe Sections-Access Pipe

Once the pipe has been properly measured, the couplings have been installed and dust covers placed back on the couplings, the pipe is ready to be installed into the duct. Refer to section 10 and Access Pipe installation instructions for details involving the proper installation of the duct conduit.

13.8.1 Fishing Pipe Through Access Pipe

Remove Access Pipe conduit from entry boots. Attach the appropriate OPW-FCS bullnose to one coupling. Fish rope through the Access Pipe conduit and attach to bullnose. Pull or push flexible piping through Access Pipe conduit.

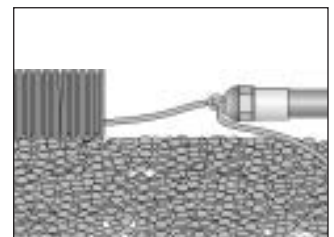

Note: For installation tips and techniques see Access

Pipe installation instructions.

13.8.2 Insert Pipe into Sump

Align the Access Pipe conduit/ flexible piping with the Access Pipe entry boot. Push piping through entry boot and attach coupling to the fitting using the methods described in section 14.

13.8.3 Insert Access Pipe into Boot

Align the Access Pipe with entry boot and push into place until duct bottoms out. Tighten band clamps to 30 in. Lbs.

13.8.4 Installation of Duct with Coax Fittings

Step 1. Drill entry boot holes using the appropriate size hole saw.

Step 2. Measure and cut the length of Duct to be installed. Sump wall to sump wall plus four inches (4"). It is recommended to snake the pipe from side to side within the trench to compensate for expansion and contraction characteristics of the pipe.



Step 3. Insert the outside portion of the Duct boot into the sump wall. Loosely install the Duct into the boot and measure from the face to face of the pre-installed Coax tee or elbow fittings within each sump. Cut the Flex flexible piping to this measurement with an OPW-FCS pipe cutter. **DO NOT COUPLE THE PIPE.**

Step 4. Using a Barbed Bull Nose fitting (FBN-3150 or FBN-3200), insert the Flex piping through the section of Duct. It is recommended to start with the longest runs so if a mistake is made, the section can be used on a shorter section of the site.

Step 5. In the following order, prepare the pipe to be coupled.

1. Place the outside portion of the Access Pipe boot over the Duct, studs pointing towards the end of the pipe.
2. Slip the black boot stiffener over the Flex and into the end of the Access pipe.
3. Slide the inside "nose" portion of the Access Pipe boot onto the end of the Flex pipe. Be sure the smaller opening of the boot is towards the pipe end.

Step 6. Coupling the Pipe. With the pipe still inside the Access Pipe, raise the entire assembly over the OPW-FCS coupling machine with a Coax coupling in position on the machine. Be sure the Flex pipe is vertical at the end and enters the Coax Coupling squarely then couple the pipe.

Repeat steps 5 and 6 on the other end of the pipe section.

Step 7. Insert the pipe assembly and boot nose through the pre-drilled hole in sump. The nose of the boot is flexible and can be folded. Use soapy water if needed.

Step 8. Prior to installing the Coax coupling to the fitting, place the compression ring of the boot over the coupling end of the pipe and complete the installation of the Access Pipe entry boot. Tighten all compression rings in a clockwise pattern not exceeding 60 in/lbs. If sealant is used on the outside portion of the entry boot, it should be applied during this step.

Step 9. Fully insert the Access Pipe and black stiffener into the Access Pipe Entry Boot and install all band clamps. Do not exceed 30 in/lbs on band clamp assemblies.

Step 10. Repeat steps 7 through 9 on the other end of the pipe. You may need to compress the Access Pipe in an accordion fashion when installing the Access Pipe at the end of the procedure. Air test Access Pipe if desired.

14.0 PIPING CONNECTIONS

After all containment sumps have been interconnected with all of the flexible pipe sections, all riser pipe assemblies and test boots (if required) have been installed, then all piping connections may proceed. There is a different installation procedure for each type of piping connection. Comply with the following connection procedures for each type.

14.1 Coaxial Coupling Connections

Coax couplings do not require the use of any tools for tightening. The following connection procedure needs to be followed for proper installation:

14.1.1 Coupling Inspection

Prior to connection, inspect coupling to make sure all rubber O-rings are properly in place and seated inside the O-ring grooves. Look for any dirt or damage to the O-rings which may have occurred during the coupling procedure. Coax nut must be fully seated for proper connection.



14.1.2 Fitting Inspection

Remove the plastic protective cap from the fitting or adapter. Inspect the fitting or adapter to be sure that it is free of sand or debris in the core area and on the threads.

14.1.3 Tightening Coax Nut

Push the pipe coupling onto the core of the fitting or adapter and hand tighten the coax swivel nut onto the threads of the fitting. Be sure that the piping does not twist while hand tightening, and verify that upon tightening, no threads are visible.



NOTE: Tighten by hand only until coupling bottoms out into fitting. Do not continue to tighten the nut once the coupling has stopped.

14.2 Swivel Couplings Connections

Swivel couplings require the use of a small swivel wrench for tightening the coupling swivel nut. The following connection procedures need to be followed for proper installation.



NOTE: If standard test boots are to be used, be sure to slide the boots onto the pipe prior to connecting to the fitting.

14.2.1 Coupling Inspection

Remove the protective cap from the swivel pipe coupling and verify that the flat ring gasket is seated in the back of the swivel nut and free of dirt and debris. If test boots are to be installed, make sure that they have been properly installed, as described in section 15.2 Installing Test Boots.



14.2.2 Fitting Inspection

Remove the plastic protective cap from the metallic fitting or adapter. Inspect the metallic fitting or adapter to be sure that it is free of sand or debris and there is no damage to the sealing face.



14.2.3 Hand Tightening of Swivel Nut

When installing swivel couplings, hand tighten the coupling onto the OPW-FCS fittings until it is snug. With an OPW-FCS swivel wrench, tighten the coupling nut ¼ turn more or to 200 in/lbs. Do not allow the pipe to rotate while tightening. The ¼ turn procedure will prevent over tightening of the coupling past the maximum 200 in/lbs.

NOTE: Failure to follow this procedure may result in damage to the coupling gasket.

15.0 TEST BOOTS

Test boots are installed only onto double wall piping that is coupled and fitted with either swivel couplings & fittings. These rubber boots must be installed onto the end of double wall pipe section prior to connecting the piping section to the fitting. Standard test boots are used with swivel couplings.

15.1 Test Boot Applications

Test Boots must be installed, for double wall piping applications, having swivel couplings & fittings installed and require a means for air pressure testing or continuous monitoring of the pipe's interstitial space.

5.1.1 Tank Sumps

Test boots installed in these sumps should be connected to the 36" (914mm) long test tubes. The fitting on the end will accept the test gauge used for air pressure testing.

15.1.2 Junction Dispenser Sumps

Test boots installed in these sumps should be interconnected with the approximate size connector tubes.

15.1.3 Terminating Dispenser Sumps

Test boots installed in these sumps should be connected to the 36" (914mm) long test tubes and plugged on the end when conducting the air pressure test.

15.1.4 In-line Piping Sump Connections

Test boots installed in these sumps should be interconnected with a custom length connector tube.

15.2 Installing Test Boots

After all pipe sections have been inserted into the containment sumps and before any piping connections are made, the rubber test boots must be installed first. The test boot has an outlet opening located on the bottom for connection to either test tubes or connector tube as described in section 16 Tubing Assemblies of this product manual. Comply with the following three step installation procedures for proper installation of the test boots.



Standard Test Boots (Swivel)

Position the Test Boot with the outlet port facing down. Align the boot so that one clamp is over the green secondary jacket and the other clamp is over the metal ferrule of the pipe coupling. Next tighten down band clamps to 30 in/ lbs.

15.2.1 Removing Band Clamps

Remove both band clamps from the test boot before installing the rubber boot over the end of the coupled flexible pipe section.

15.2.2 Installing Test Boot

From inside the containment sump, slide the test boot over the installed pipe section end of the pipe section.

16.0 TUBING ASSEMBLIES

OPW-FCS flexible piping systems incorporates the use of plastic tubing for purposes of providing convenient access to, and interconnecting of the interstitial space of the double wall flexible piping line. Double wall piping having either swivel or barbed piping connections and installed with test boots can be fitted with both test tubes and connector tubes. Double wall piping having coax piping connections can be fitted using only coax test tubes.

16.1 Test Tubes

There are two types of test tubes available for use with double wall piping: one for connection to coaxial fittings & adapters and the other for connection to test boots installed with swivel piping connections. These 36" (914mm) long

plastic tubes assemblies are designed to provide convenient access to the beginning and end of a double wall pipe line for initial and periodic air pressure integrity testing.

16.1.1 Coax Test Tubes

These 3/8" tubes are 36" long (914mm) with a 1/4" female fitting installed on one end. The other end has a nylon male 1/4" NPT threaded connection which connects to the 1/4" NPT threaded test port of the coax pipe adapter.



CAUTION: Do not install metallic fittings into Coax test ports.

16.1.2 Standard Test Tubes

These 3/8" tubes are 36" long (914mm) with a 1/4" female brass fitting installed on one end. The other end has a male barbed elbow with band clamp attached for connection to the 3/8" port of the rubber test boot used with metallic couplings & fittings.

16.2 Connector Tubes

These short plastic tube assemblies connect one test boot to another to reroute the interstitial space of one flexible pipe section around a tee or connector fitting to the next flexible pipe section.

16.2.1 Connected Connector Tubes

After initial integrity testing has been completed, the connector tubes can remain connected if interstitial product flow is desired to run the length of the pipe line back to the tank sump.

NOTE: Dispenser sump leak detection is required to monitor the integrity of piping, when the connector tubes are connected.

16.2.2 Disconnected Connector Tubes

After initial integrity testing has been completed, the connector tubes can be disconnected if interstitial product flow is desired from sump to sump. One end in each dispenser sump should be disconnected from the test boot.

17.0 VENT FLEXIBLE VENT PIPING

This flexible piping is used for the transmission of aromatic fuel vapors and is designed for direct burial of the pipe and fittings without the requirement for secondary containment. The intended use for *Vent* is for venting vapors from an underground storage tank to a remotely located vent stack.

IMPORTANT: Vent is available in both 2" and 3" sizes and is not intended for the transfer of fluids.

17.1 Vent Connections

The *Vent* piping system requires the use of swivel couplings & fittings. Unlike supply piping connections OPW-FCS permits *Vent* swivel connections to be direct buried when properly protected.

17.2 Tank Connections Within Tank Sump

If the tank's vent connection is contained within a tank sump, the vent line should enter through a flexible entry boot. A male or female adapter fitting should be used to complete the connection within.

17.3 Tank Connections Extractor Fitting

If the tank's vent connection is not contained within a tank sump, then a male or female adapter fitting should be installed in the extractor fitting to accept the OPW-FCS Piping. The adapter and coupling/fitting should be properly protected.

17.4 Pipe Branch Connections

In between the beginning and end of a *Vent* piping line it may be necessary to install tee fittings to interconnect numerous pipe runs into a main return line to the tank. For this application the coax junction tee or coax branch tee may be used.

17.5 Vent Stack Connections

At the other end of a *Vent*™ pipe line the pipe connects to a vent stack for tank vapor venting applications. This connection is made using an elbow fitted to the appropriate coupling. Metallic fittings may be wrapped with pipe tape to further protect the fitting components from corrosion.

18.0 TESTING & FILLING SUPPLY PIPE

It is important to properly test the flexible piping prior to backfill to insure there are no leaks. The following test procedures are provided as a guideline only and the manufacturer assumes no responsibility or liability for the consequences of any testing practices.

IMPORTANT: Integrity testing with air or gas can be dangerous and it is very important that the proper testing equipment be used and that the pre-testing procedures be read.

18.1 Testing Equipment

- Pressurizing equipment should be of sufficient size to accommodate line pressure testing requirements.
- Pressurizing equipment should have controls to gradually increase pressures.
- Pressurizing equipment should be operated by experienced and qualified personnel only.
- The pressure gauge should be located in close proximity to the pressurizing equipment.
- Pressure gauges must have a full scale reading not to exceed twice the required test pressure.
- Pressure gauges should be accurately and routinely tested for reliability.

18.2 Pre-Testing Procedures

- The underground storage tank should be isolated from the piping system prior to hydrostatic or air testing.
- Shear valves located under dispensers should be sealed with pressure rated plugs or caps.
- Long flex piping runs should be secured at various points with backfill material.
- All pipe coupling/swivel connections should be tightened securely before testing.
- The interstitial (secondary) line should be interconnected and fitted with an air gauge.
- All local building, safety and fire codes should be followed prior to and during testing.

18.3 Air Pressure Testing Procedures

The air pressure integrity test procedure for the flexible supply piping is one and one half (1-1/2) times the normal operating pressure of the submersible pump, not to exceed sixty pounds per square inch (60 psi). Make sure the flexible pipeline is isolated from both the underground storage tank and the above ground product dispenser when conducting this test. All pressure testing should be conducted by qualified and experienced personnel. Do not attempt to disconnect couplings, caps, or plugs unless the air pressure has been released.

NOTE: Testing requirements must be in accordance with all applicable codes.

18.3.1 Air Pressurize

Gradually apply air pressure into the flexible piping line. Do not exceed sixty pounds per square inch (60 psi) or 416 kPa.

18.3.2 Air Pressure Holding

Maintain pressure for a minimum of three hours, making sure that there is no drop in pressure.

Note: Significant temperature changes can result in a pressure reading differential.

18.3.3 Air Pressure Holding for Coax

PRE-BACKFILL Maintain pressure for a minimum of three hours. POST-BACKFILL Maintain pressure for a minimum of three hours.

NOTE: Do not close off or apply pressure to secondary jacket until primary pressure is maintained for a minimum of one hour.

18.3.4 Test Tube Gauge Check

During pressurizing, check the reading on the test gauge which should be connected to the test tube of the inter-connected interstitial line. Any increase in pressure will indicate a leak.

18.3.5 Soap Test

During the pressurizing period, apply a soapy water solution to all piping connections and inspect for bubbles.

18.4 Hydrostatic Testing Procedures (if applicable)

The recommended hydrostatic pressure integrity test procedure for the flexible supply piping is one and one half (1-1/2) times the normal operating pressure of the submersible pump, not to exceed sixty pounds per square inch (60 psi). Make sure the flexible pipeline is isolated from the underground storage tank and the above ground product dispenser when conducting this test. All pressure testing should be conducted by qualified and experienced personnel. Do not attempt to disconnect couplings, caps, or plugs unless the air pressure has been released.

Note: OPW-FCS recommends hydrostatic testing on all sumps after installation is complete to check for proper sealing of joints and connections.

18.4.1 Water Filling

Gradually introduce water at the lowest point into the piping system and bleed off air at the highest point in the piping

system through an open valve. The hydrostatic pressure applied should not exceed 60 psi.

18.4.2 Pressure Hold Inspection

Maintain pressurization for a minimum of one hour making sure there is no drop in pressure. Significant temperature changes can result in a pressure reading differential. During the pressurizing period, inspect all piping connections for leaks.

18.5 Supply System Filling

After the supply piping system has been integrity tested and connected to the product dispensers, filling of the pipe line may commence. There should be a controlled method for filling the supply line which provides an adequate means of removing air from the lines. Do not start pumps with empty lines, as it may damage the pipe and its connections. Small amounts of trapped air should dissipate under normal operations. Make sure that the pressure rating of the submersible pump does not exceed that of the maximum operating pressure of the pipe.

19.0 PERIODIC LINE LEAK DETECTION

Local or federal regulations may require periodic line leak detection tests be performed on the installed piping system. Testing requirements affect both suction and pressure piping systems. A typical requirement is that the piping lines must be tested on an annual basis at one and one half (1-1/2) times the normal operating pressure. The typical test method will require detection of 0.10 gallons (.3785 liters) per hour with a 95% probability of detection and a 5% probability of a false alarm.

The typical test procedure requires the piping be isolated from the tank and the piping line pressurized to 1-1/2 times the normal operating pressure. A test apparatus which is connected to the piping line will then measure the bleedback volume of the piping system. Acceptable bleedback volumes on different types of piping systems will vary due to their inherent expansion and contraction characteristics. Therefore, modifications in the testing procedures are required for piping systems which have significant expansion and contraction characteristics. This characteristic is measured in the average volume increase, per linear foot under a standard test pressure.

19.1 FlexWorks Piping Expansion Characteristics

FlexWorks Piping is a multi-layer reinforced smooth bore flexible pipe which demonstrates only minor expansion and contraction characteristics during pressurization and depressurization, similar to that of fiberglass piping. These physical characteristics reduce the affect on the "bleedback tolerances" permitting a more accurate testing procedure.

Piping Expansion Characteristics	
Pipe Description	Volume Increase
1-1/2" Flex Flexible Piping	+ 0.0015
2" Fiberglass Piping	+ 0.00045
1-1/2" Flexible Connectors	+ 0.0060

*Volume increase = gallons per lineal foot at 60 psi pressure. Does not apply to Flex Plus piping.

20.0 INTERSTITIAL INTEGRITY TESTING

Prior to supply filling and periodically over the life of the flexible piping system, it is recommended that interstitial testing be used to ensure that the secondary containment is intact.

20.1 Air Pressure/Soap Testing

After the inner primary flexible pipe and piping connections have been integrity tested, the entire interstitial space of the double wall pipe must remain connected and only then should the outer containment jacket be integrity tested. The connections of the test boots are illustrated and explained in [Section 15.2](#) of this product manual.



20.2 Testing Assembly

Inside all tank sumps the test gauge is connected to the end of the test tube. The test gauge assembly consists of an air gauge with a maximum 15 psi scale connected to a 1/4" brass tee fitting with a male 1/4" thread. The gauge threads directly into female brass fitting of the test tubes. The test tube in the terminating sump shall be capped with a .25" brass plug.

20.3 Air Pressure Testing

Gradually pressurize the piping's interstitial space through the test tube to no more than 10 psi. During the pressurization period, apply an air pressure soap test to the entire piping line. After testing, disconnect the air hose and lay the test tube down into the bottom of the tank sump.

IMPORTANT: Coax fittings require interstitial testing before and after backfill.

21.0 FLEXWORKS SYSTEM MAINTENANCE

The FlexWorks System is designed to provide reliable underground fuel transfer and short-term secondary containment of leaked petroleum product. FlexWorks sumps and secondary containment pipes are not intended for long term storage of petroleum products. Liquid that accumulates in the secondary containment system must be promptly removed and properly disposed of. Operational third party approved liquid sensors should be installed and maintained in each sump to reliably indicate to the operator that liquid is present in the secondary containment system. Once a leak is detected, the system must be shut down immediately and the source of the leak must be repaired. All liquid must be thoroughly flushed and cleaned out of the secondary containment system at once. Inspect all system components at least monthly for leaks or damage, and repair or replace any suspect component as necessary.

21.1 ROUTINE SUMP INSPECTIONS

Visual inspections of all containment sumps and components should be made on a routine basis to check for damage, water infiltration or for any signs of leaking product. An electronic or mechanical shut-off leak detection system is recommended for all containment sumps. When changing fuel filters at the dispenser, make sure any spilled product is cleaned out of the bottom of the dispenser sump. Sumps are to be kept free of debris and spilled fuel.

NOTE: Failure to remove fuel and liquids from containment sumps may compromise the performance and integrity of the sump and its associated fittings and

seals over prolonged periods of time.

Always follow warranty registration instruction and return warranty forms to OPW-FCS.

21.2 STORAGE AND TRANSIT

Instructions shall specify that pipe and fittings are not intended for storage in direct sunlight or excessive temperatures and that rough handling (drops and impacts) during storage and transit may cause damage and leaking. Any special procedures for protection against environmental conditions and physical abuse during storage and transit shall be identified. Any special procedures for the inspection of parts for non-complying damage before assembly shall be identified with instructions specifying that a damaged part shall not be used.

22.0 PERIODIC INTERSTITIAL TESTING

For periodic integrity testing of the interstitial space of the double wall pipe there is a different setup procedure for systems using coax fittings versus steel fittings with connector tubes. Both applications should have test tubes connected on each end. If they have been disconnected, reconnect them before testing. Follow the air pressure test procedures below for interstitial integrity testing.

22.1 Reconnect Test Tubes

If necessary, reconnect the test tube located inside the tank sump to the test boot. Connect the test gauge assembly to the top end of the test tube.

22.2 Reconnect Connector Tubes

If the piping system includes test boots with connector tubes then make sure all connector tubes have been reconnected.

22.3 Plug Test Tube

Plug and seal the test tube fitting located at the terminating end of the flexible piping line.

22.4 Air Pressurize

Pressurize the interstitial space to 10 psi for a period of one hour, in accordance with Section 21, *Interstitial Integrity Testing*. If required, disconnect all tubes after test.

23.0 PROBLEMS

Investigation

If leakage or damage is detected in any part of the system (either by inspection of the sump, a leak detector, or similar monitors), the problems are to be immediately investigated by the site operator.

Warning: Ignoring or disabling leak detection alarms may lead to further damage and possible failure.

Notification

If leakage or damage to the piping system is verified, notify the Technical Service Department of OPW Fueling Containment Systems at one of the below noted phone numbers:

- 1-800-422-2525 Toll Free
- 1-919-934-2786 Extension 104

24.0 GUIDE SPECIFICATIONS

24.1 Short Form

The contractor shall provide a flexible underground piping system whereby the flexible piping, fittings, adapters and under dispenser riser pipes are secondarily contained and having no metallic components exposed to the environment. The primary pipe shall be capable of being air pressure tested to 1.5 times the operating pressure of the pump not exceeding 60 psi. The secondary shall be capable of being air tested to 10 psi.

24.2 Long Form

The following guide specification is designed around the use of OPW-FCS's flexible piping.

24.2.1 Design

The contractor shall provide a secondarily contained flexible underground piping system that shall provide secondary containment for all primary piping, couplings, fittings and adapters. Piping runs shall be continuous between containment chambers (ie., tank & dispenser sumps or pans) in which all joints are contained within the containment chambers. The piping design shall allow for any leak in the primary supply or secondary containment piping to be directed to a leak detection sensor.

24.2.2 Product And Chemical Compatibility

The flexible underground piping and associated couplings, fittings and adapters shall be chemically compatible with the products to be transported and with chemicals found naturally in the ground environment. The primary & secondary piping shall be compatible with gasoline, alcohols, gasoline-alcohol mixtures and all EPA approved additives, including MTBE.

24.2.3 Corrosion Resistance

The flexible underground piping and associated couplings, fittings and adapters which come in contact with the ground environment shall be made of non-metallic material or encapsulated by non-metallic components which prevent corrosion.

24.2.4 Structural Integrity

The flexible underground piping and associated couplings, fittings and adapters shall be designed and constructed of materials strong enough for its intended use. The flexible piping shall not collapse, crack or break due to ground movement or from backfill and high ground water pressures. Piping shall be able to transfer fluid up to a maximum temperature of 125 degrees fahrenheit (52 degrees celsius). Piping shall be operational with in a temperature band of minus 40C and +65C.

24.2.5 Bend Radius

The double wall flexible piping shall be capable of a minimum bend radius without kinking, cracking or breaking. The minimum bend radii shall be equal to or less than the following:

- 0.75" - 18" radius
- 1.0" - 18" radius

- 1.5" - 24" radius
- 2.0" - 36" radius
- 3.0" - 48" radius

24.2.6 Fluid Flow Efficiency

Both the primary inner and secondary outer pipe shall have an interior surface which is a smooth (non-corrugated) profile and be made of a low friction resistant material for improved fluid flow efficiency.

24.2.7 Operating Pressures & Vacuums

The flexible underground piping shall have a minimum five to one (5:1) safety factor from maximum operating pressure for rated pressure. The maximum operating pressure rating for 1.5" diameter piping shall be 100 psi primary and 10 psi secondary. 3/4", 1", 2" and 3" piping shall be rated at a maximum operating pressure of 75 psi primary and 10 psi secondary. For suction systems the pipe shall be capable of withstanding 29" mercury vacuum.

24.2.8 Pipe Expansion

The primary supply pipe shall not expand more than .0025% in diameter and overall length when pressurized to 60 psi to permit accurate pressure decay readings by an in-line leak detector.

24.2.9 Interstitial Interconnection

All primary and secondary piping shall be connected in such a way as to permit integrity testing both during installation and at periodic intervals in the future. Both primary and secondary piping shall remain continuous during operation.

24.2.10 UL® Testing

Flexible piping and it's associated fittings shall be independently tested in accordance with UL 971.

25.0 Storage and Handling

25.1 Storage

OPW-FCS requires that all piping, fittings and system components be stored in such a manner that they will not be subject to direct sunlight and / or excessive environmental conditions. Please review the below noted warnings during product storage.

- Cover all products with UV protective tarps if outside.
- If tarps are unavailable, store in trailer or building until use.

25.2 Handling

OPW-FCS requires that the piping, fittings and system components are handled in such a manner that it will not cause unnecessary damage to the system components. Please review the below noted warnings during product handling.

- Do not drop, cut or impact the components.
- Keep all piping, fittings and components in the original packaging until ready to use.
- Keep all thread protectors secure until ready to use.

- Keep all coupling protector caps / covers in place.
- DO NOT drag, cut or scrape pipe.
- Upon completion of pipe, inspect for cuts, scrapes and damage prior to close of pipe runs.
- DO NOT exceed 15° angle entry for pipe into a sump.

Please visit our website, www.opwglobal.com, for a detailed guide specification.

LIMITED WARRANTY

NOTICE: FlexWorks by OPW, Inc., VAPORSAVER and all other OPW products must be used in compliance with all applicable federal, state, provincial and local laws, rules and regulations. Product selection must be based on physical specifications and limitations, compatibility with the environment and material to be handled. All illustrations and specifications in this literature are based on the latest production information available at the time of publication. Prices, materials and specifications are subject to change at any time, and models may be discontinued at any time, in either case, without notice or obligation.

OPW warrants solely to its customer that the following products sold by OPW will be free from defects in materials and workmanship under normal use and conditions for the periods indicated:

Product	Warranty Period
FlexWorks Primary Pipe	10 years from date of manufacture
All Products Certified to California 2001 Standards*	1 year from date of manufacture or from date of installation registration (Not to exceed 15 months from date of manufacture)
All other Products	1 year from date of manufacture
* Products certified to California 2001 Standards will have an OPW registration card enclosed/attached to the product.	

OPW's exclusive obligation under this limited warranty is, at its option, to repair, replace or issue credit (in an amount not to exceed the list price for any defective product) for future orders for any product that may prove defective within the applicable warranty period (repairs or replacements are subject to prorated warranty coverage for remainder of the original warranty period). Complete and proper warranty claim documentation and proof of purchase required. All warranty claims must be made in writing and delivered during the applicable warranty period to OPW at P.O. Box 405003, Cincinnati, Ohio 45240, Attention: Customer Service Manager. No products may be returned to OPW without its prior written authority.

This limited warranty shall not apply to any FlexWorks or VAPORSAVER product unless it is installed by an OPW attested installer. This limited warranty also shall not apply to any FlexWorks, VAPORSAVER or other OPW product: unless all required site and warranty registration forms are completed and received by OPW within 60 days of installation; unless all piping connections are installed with a nationally-recognized or state-approved leak detection device in each tank and dispenser sump (which are not for storage and from which all discharge hydrocarbons must be removed, and the systems completely cleaned, with 24 hours); unless testable sumps utilize FlexWorks pipe and access fittings; unless a sump inspection log or an EPA recommended/required checklist is maintained and the results are furnished to OPW upon request; and unless OPW is notified with 24 hours of any known or suspected product failure and is provided with unrestricted access to the product and the site. This limited warranty also shall not apply to any product which has been altered in any way, which has been repaired by anyone other than a service representative authorized by OPW, or when failure or defect is due to: improper installation or maintenance (including, without limitation, failure to follow FlexWorks Quick Reference Manual Installation Guide and all product warning labels); abuse or misuse; violation of health or safety requirements; use of another manufacturer's, or otherwise unauthorized, substances or components; soil or other surface or subsurface conditions; or fire, flood, storm, lightning, earthquake, accident or any other conditions, events or circumstances beyond OPW's control.

THIS LIMITED WARRANTY IS IN LIEU OF ALL OTHER WARRANTIES, EXPRESS OR IMPLIED, AND ALL OTHER WARRANTIES INCLUDING, WITHOUT LIMITATION, THE WARRANTIES OF MERCHANTABILITY AND FITNESS FOR A PARTICULAR PURPOSE, ARE HEREBY EXCLUDED. OPW shall have no other liability whatsoever, whether based on breach of contract, negligence, gross negligence, strict liability or any other claim, including, without limitation, for special, incidental, consequential or exemplary damages or for the cost of labor, freight, excavation, clean-up, downtime, removal, reinstallation, loss of profit, or any other cost or charges. No person or entity is authorized to assume on behalf of OPW any liability beyond this limited warranty. This limited warranty is not assignable.



OPW Fueling Containment Systems

3250 US 70 Business West

Smithfield, N.C., 27577

Customer Service: 1-800-422-2525

Customer Service Fax: 1-800-421-3297

Technical Service: 1-919-934-2786 x104

www.opwglobal.com

Notice: OPW-FCS products must be used in compliance with applicable federal, state, provincial and local laws and regulations. Product selection should be based on physical specifications and limitations and compatibility with the environment and material to be handled. OPW-FCS makes no warranty of fitness for a particular use. All illustrations and specifications in this literature are based on the latest production information available at the time of publication. Prices, materials and specifications are subject to change at any time, and models may be discontinued at any time, in either case, without notice or obligation. For complete OPW-FCS warranty information, visit our web site at www.opwglobal.com.